

# CATALOGO GENERALE

---

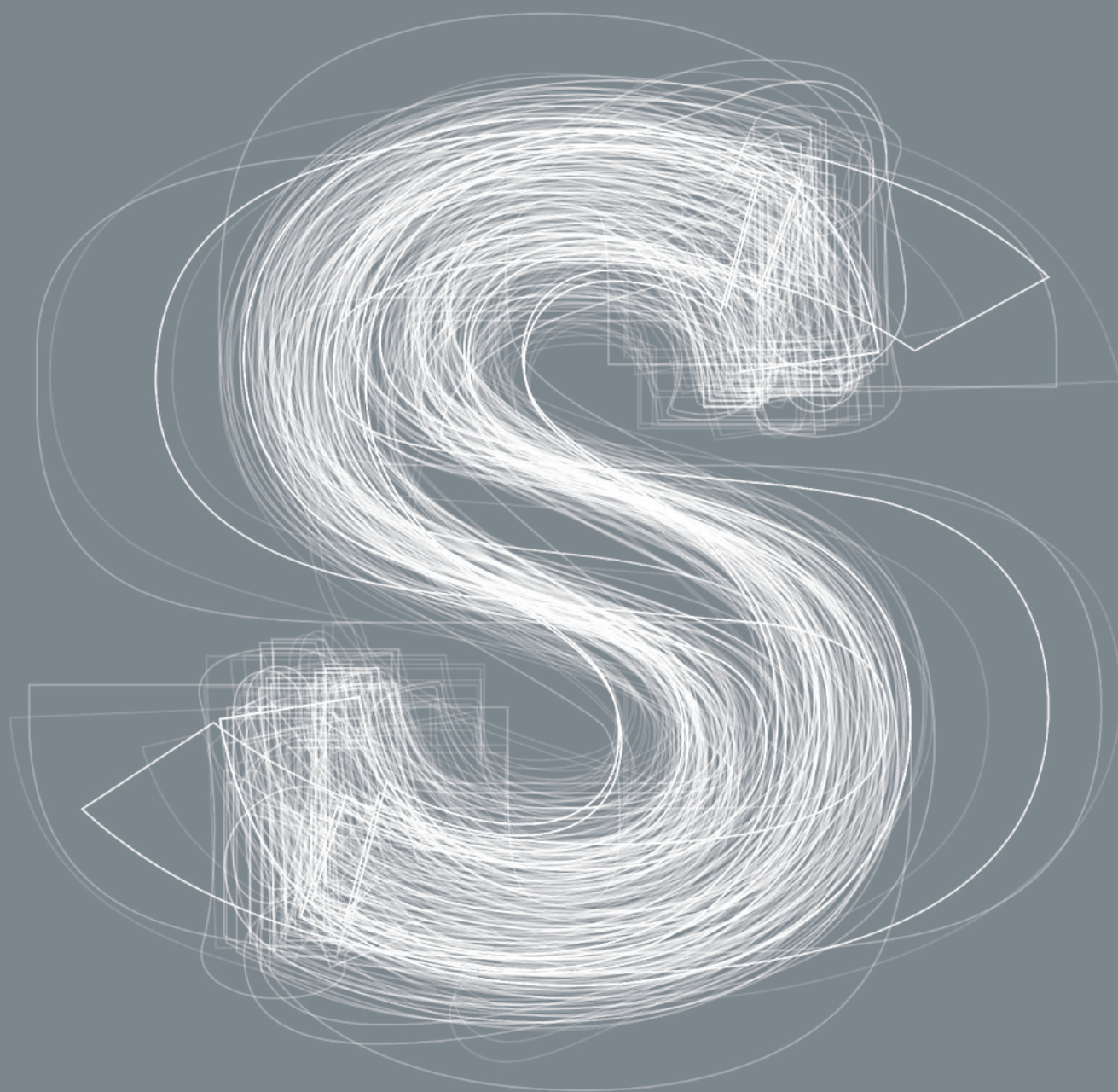

simas

An Italian History.

**simas**

# simas

## DAL 1955, UNA SOCIETÀ FATTA DI PERSONE

*A company made of people, since 1955*

*Depuis 1955, une société faite de personnes*

*Ein aus Menschen geformtes Unternehmen seit 1955*

*Компания с собственным лицом, с 1955 года*





# AN ITALIAN HISTORY

Since 1955

## 70 anni di storia Italiana

12 luglio 1955. Simas nasce a Civita Castellana, già allora territorio con un'elevata capacità di lavorazione manuale tramandata di padre in figlio. Oggi come ieri, è una realtà fatta di persone che si impegnano a dare concretezza a progetti nei quali ognuno lavora secondo le proprie competenze. Una società per azioni con 68 soci, 109 dipendenti e 150mila pezzi prodotti all'anno. Rigorosamente made in Italy, per costruire, insieme, tendenze sempre attuali e contemporanee che durano nel tempo, frutto di un know how consolidato e tramandato nel nome dell'etica del lavoro.

## 70 years of Italian history

12 July 1955. SIMAS was born in Civita Castellana, which even at that time had a high capacity for manual production processes handed down from father to son. Today as yesterday, it is a company made up of people who are committed to developing concrete projects in which everyone works according to their skills. A stock company with 68 shareholders, 109 employees and 150.000 pieces produced annually. Strictly made in Italy, aimed at building, together, trends that are always up-to-date and contemporary and that last over time, the result of consolidated

know-how and expertise handed down in the name of work ethic.

## 70 ans d'histoire italienne

12 juillet 1955. Simas est créée à Civita Castellana, un territoire qui présentait déjà à cette époque une capacité élevée de travail manuel transmis de père en fils. Hier comme aujourd'hui, cette entreprise est faite de personnes qui travaillent dur pour donner un caractère concret à des projets dans lesquels chacun agit selon ses propres compétences. C'est une société par actions avec 68 associés, 109 salariés et 150.000 pièces produits par an. Rigoureusement made in Italy, pour construire, ensemble, des tendances toujours actuelles et contemporaines qui durent dans le temps, fruit d'un savoir-faire consolidé et transmis au nom de l'éthique du travail.

## 70 Jahre italienischer Geschichte

12. Juli 1955. Simas wird in Civita Castellana gegründet, einem Gebiet, das bereits für seine handwerkliche Tradition, vom Vater an den Sohn weitergegeben, verfügt. Damals wie heute besteht die Firma aus Personen, die sich dafür einsetzen, die Projekte, an denen jeder nach seinen persönlichen Kompetenzen arbeitet, konkret in die Tat umzusetzen.

Die Aktiengesellschaft besteht aus 68 Gesellschaftern, 109 Angestellten und 150.000 hergestellten Produkten pro Jahr. Die Produkte werden allesamt streng ausschließlich in Italien hergestellt, um gemeinsam aktuellste und zeitgenössische Trends zu konstruieren, die dauerhaft sind und das Ergebnis eines gefestigten Wissens darstellen, das im Namen der Arbeitsethik weitergegeben wird.

## 70 лет итальянской истории

12 июля 1955 года. Simas рождается в Чивита Кастеллана, уже тогда территории с высоким уровнем мастерства ручной обработки, передаваемого из поколения в поколение. Сегодня как вчера, действительность, состоящая из людей, занятых в конкретизации проектов, в которых каждый работает в соответствии с собственными компетенциями. Это акционерное общество с 68 акционерами, 109 работниками и 150 тысячами производимых единиц продукции в год. Строго made in Italy, для создания совместными усилиями всегда актуальных и современных с течением времени тенденций, плод упроченного ноу-хау, передаваемого под эгидой трудовой этики.



# HAND-MADE IN ITALY

A meeting between the Artisan and Industry

## La parte è nel tutto, il tutto è nella parte

Simas, profondamente sé stessa nella sua forza 'artigianale' volutamente spinta e, nel contempo, in continua evoluzione con due prerogative: tutto rigorosamente made in Italy e tutto rigorosamente lavorato con processo interno, dal collaggio e verniciatura ai tunnel di cottura al sistema di codice a barre, con un percorso che va dalla logistica interna fino alla distribuzione.

Simas, emblema dell'artigianalità insita nel Dna italiano, continua a puntare sui principi originari: opinioni in comune, lavoro di squadra, agenti fidelizzati, puntuale assistenza in fase di preventida e post vendita.

## The part is in the whole and the whole is in the part

SIMAS prides itself in its dedication to "handcrafted" tradition and, at the same time, to continual evolution, based on two prerogatives: all strictly made in Italy and all strictly manufactured internally from casting and painting to the cooking tunnels and barcode system, with a path that goes from the internal logistics until the distribution.

SIMAS, an emblem of Italian craftsmanship, continues to focus on the original principles: shared opinions, team

work, loyal agents, prompt pre-sales and post-sales assistance.

## La partie est dans le tout, le tout est dans la partie

Simas est à la fois profondément elle-même dans sa force artisanale exagérée par choix et en évolution permanente avec deux prérogatives: tout est rigoureusement made in Italy et tout est rigoureusement réalisé avec un processus interne qui part du coulage et du vernissage jusqu'aux tunnels de cuisson et au système de code barres, grâce à un parcours qui commence à la logistique interne et se termine à la distribution.

Simas, emblème du travail d'artisan ancré dans l'ADN italien, continue à cibler ses principes originaux: avis en commun, travail d'équipe, agents fidélisés, assistance ponctuelle avant et après-vente.

## Das Teil in allem, in allem das Teil

Simas ist ganz es selbst in seiner bewusst gewollten „gewagten“ handwerklichen Kraft und befindet sich mit zwei seiner Grundsätze stets in ständiger Entwicklung: Alles ist rigoros „Made in Italy“ und alles wird rigoros intern hergestellt, vom Guss über die Lackierung bis hin zu den Brenntunneln

und dem Barcodesystem, mit einem Weg, der von der internen Logistik bis zur Auslieferung geht. Simas ist Sinnbild des in der italienischen DNA befindlichen Handwerks und setzt weiterhin auf seine Grundprinzipien: gemeinsame Meinungen, Teamarbeit, vertrauensvolle Handelsagenten und pünktlicher Kundenservice vor und nach dem Verkauf.

## Часть в целом, целое в части

Simas глубоко является самой собой в ее намеренно продвинутой «ремесленной» силе и одновременно находится в постоянном развитии с двумя прерогативами: все строго made in Italy и все строго обработано в ходе внутреннего производственного процесса, от отливки и окрашивания до обжигающих туннелей и системы штриховых кодов, с продуманной системой от внутренней логистики до распределительной сети. Simas представляет собой эмблему мастерства, заключенного в итальянском ДНК, продолжает делать упор на первоначальные принципы: общие мнения, работа в коллективе, верные агенты, хорошая поддержка на предпродажном и послепродажном этапе.



Processo di essiccamento industriale della produzione ceramica di Simas.

Industrial drying process for Simas's production of ceramics.

Procédé de séchage industriel de la production de céramiques Simas.

Industrielle Trocknung der Keramikherstellung bei Simas.

Процесс промышленной сушки керамических изделий Simas.

# TRUE ETHIC AND QUALITY

Excellence through tradition and respect

# CERTIFICATIONS

The acknowledgement of our efforts



## Mission 100% Made in Italy

SIMAS si fregia del marchio Ceramics of Italy, 'sigillo' di Confindustria Ceramica inteso a valorizzare il patrimonio storico, culturale e produttivo della tradizione ceramica italiana. Ceramics of Italy quindi come sinonimo di eccellenza Italiana, appannaggio solo di selezionate aziende del settore. Simas è fra queste.

## Mission 100% Made in Italy

SIMAS proudly boasts the Ceramics of Italy trademark, a 'seal of approval' from Confindustria Ceramica designed to promote and develop the historical, cultural and production heritage of traditional Italian ceramics. The "Ceramics of Italy" trademark is therefore a symbol of Italian excellence, given to a select number of companies. Simas is one of these.

## Mission 100% Made in Italy

SIMAS vante le label Ceramics of Italy, « sceau » de Confindustria Ceramica qui valorise le patrimoine historique, culturel et productif de la tradition céramique italienne. Ceramics of Italy est donc un synonyme d'excellence à l'italienne, apanage de quelques entreprises sélectionnées du secteur. Simas en fait partie.

## Mission 100% Made in Italy

SIMAS trägt die Auszeichnung Ceramics of Italy, dasn 'Siegel' der Confindustria Ceramica zur Aufwertung des historischen, kulturellen und produktiven Vermächtnisses der italienischen Tradition der Keramikherstellung. Ceramics of Italy steht also für italienische Spitzzeugnisse, für einen erlesenen Kreis der Hersteller der Branche. Darunter auch Simas.

## Mission 100% Made in Italy

Компания SIMAS была удостоена знака Ceramics of Italy, 'марки' Confindustria Ceramica (Итальянского Объединения Промышленников, работающих в области керамики), предназначенного для валоризации исторического, культурного и промышленного наследия итальянской керамической традиции. Поэтому Ceramics of Italy является синонимом итальянского совершенства, прерогативой только некоторых предприятий отрасли. Среди них и Simas.

Si certifica che SIMAS S.p.A ha aderito all'iniziativa **ioCO2MPENSO** grazie alla quale ha compensato le sue emissioni annuali di CO2 attraverso la piantumazione e tutela di 200 alberi nell'ambito del progetto di riforestazione.

It is certified that SIMAS SPA took part to the project **ioCO2MPENSO**, thanks to which it has balanced its yearly emissions of CO2, by planting and taking care of 200 trees, according to the reforestation program.

Il est certifié que SIMAS a participé au projet **ioCO2MPENSO**, grâce auquel elle a balancé ses émissions annuelles de CO2 en plantant et protégeant 200 arbres, dans le cadre du programme de reforestation.

**ioCO2MPENSO**  
New World in Green

Es wird zertifiziert, dass Simas am Projekt **ioCO2MPENSO** teilgenommen hat und dass sie ihre CO2 Emissionen durch der Pflanzung und Pflege von 200 Bäume balanciert hat, im Bereich des Wiederaufforstungsplans.

Настоящим удостоверяется, что SIMAS S.p.A. присоединился к инициативе **ioCO2MPENSO**, для которого он компенсировал его ежегодных выбросов CO2 за счет посадки и защиты 200 деревьев в рамках проекта лесовосстановления.



## Certificazione "di Processo" e "di Gestione Ambientale"

SIMAS è certificata CERMET, con due importanti normative: UNI ISO 9001 - 2015 per la qualità del processo e UNI ISO 14001 - 2015 per una corretta gestione ambientale. Norme che definiscono i requisiti per la realizzazione di sistemi di gestione della qualità e che garantiscono il rispetto delle normative ambientali.

## Certificazione "UPC" e "WaterMark"

Dal 2016 alcuni prodotti SIMAS di particolare interesse sui mercati internazionali (contrassegnati all'interno del catalogo), sono certificati secondo le normative WaterMark (Australia e Nuova Zelanda) e UPC (Stati Uniti e Canada) che ne garantiscono la rispondenza ai severi standard esistenti in tali Paesi in materia di apparecchiature idrauliche.

## 'Process' and 'Environmental Management' Certification

SIMAS is CERMET certified, with two important standards: UNI ISO 9001 - 2015 for process quality and UNI ISO 14001 - 2015 for correct environmental management. Regulations that stipulate the requirements for the creation of quality management systems and guarantee respect for the environment.

## "UPC" and "WaterMark" Certification

Starting from 2016 some products from SIMAS, which are of particular interest on the international markets (marked inside the catalogue) are certified to be in compliance with the norms of WaterMark (Australia and New Zealand) and UPC (USA and Canada) proving the compliance with the strict standards existing in those countries for plumbing fixtures and appliances.

## Certification de processus et de gestion environnementale

Simas est certifié CERMET avec deux normes importantes: UNI ISO 9001-2015 pour la qualité du processus et UNI ISO 14001-2015 pour une gestion correcte de l'environnement. Ces normes définissent les caractéristiques nécessaires pour la réalisation des systèmes de gestion de la qualité et qui garantissent le respect des normes environnementales.

## Certification "UPC" et "WaterMark"

A partir du 2016 certains produits de SIMAS, qui recouvrent un intérêt particulier dans les marchés internationales et qui sont marqués avec le logo correspondant à l'intérieur du catalogue, sont certifiés selon les normes WaterMark (Australie et Nouvelle Zélande) et UPC (Etats-Unis et Canada) qui garantissent le respect des très stricts standards qui existent dans ces Pays en matière d'appareil sanitaires.

## Zertifizierung „Process“ und „Environmental Management“

SIMAS wird CERMET zertifiziert, mit zwei wichtige Regeln: UNI ISO 9001 - 2015 für die Qualität „des Prozesses und ISO 14001 - 2015 für das ordnungsgemäße Umweltmanagement. Vorschriften zur Festlegung der Anforderungen für die Implementierung von Systemen des Qualitätsmanagements und die Einhaltung von Umweltauflagen.

## Zertifizierung "UPC" und "WaterMark"

UPC" und "WaterMark" Zertifizierung Seit 2016 sind einige Produkte von SIMAS, die auf internationalen Märkten von besonderem Interesse sind (im Katalog markiert), nach den Richtlinien WaterMark (Australien und Neuseeland) und UPC (USA und Kanada) zertifiziert, die die Einhaltung der strengen Standards in diesen Ländern im Bereich der hydraulischen Anlagen gewährleisten.

## Сертификация "Производственного процесса" и "Защита окружающей среды"

SIMAS имеет сертификацию CERMET с двумя важными нормативами: UNI ISO 9001 - 2015 - по качеству производственного процесса и UNI ISO 14001 - 2015 по корректному отношению к окружающей среде. Нормативы, которые определяют требования к системе контроля качества и гарантирующие соблюдение норм по защите окружающей среды.

## Сертификация "UPC" и "WaterMark"

Начиная с 2016 года, некоторые продукты Simas, представляющие особый интерес для экспортных рынков (они отмечены в каталоге), были сертифицированы в соответствии с нормативами WaterMark (Австралия и Новая Зеландия) и UPC (США и Канада), гарантирующими соответствие строгим стандартам качества сантехнического оборудования, существующим в этих странах.

# ECO SUSTAINABILITY

Productivity and environmental awareness

## Attenzione alle materie prime

Denominatore comune in Simas la qualità estrema dei materiali e il talento del saper fare italiano, che fa la differenza. Una produzione che rispetta le politiche ambientali in tutto il processo produttivo, impostato su precisi parametri di controllo e verifica di ogni fase della lavorazione, con l'utilizzo di tecnologie avanzate e un'accurata ricerca sui materiali e sul loro smaltimento, per garantire al prodotto una qualità in più e per la massima tutela dell'ambiente nel senso più ampio del termine, a cominciare dai luoghi dove si svolge la produzione.

## Smaltimento e recupero

Fra le prime aziende del distretto di Civita Castellana, già nel 2010 Simas ha partecipato all'innovativo impianto di recupero del gesso esausto del Centro Ceramico civitonico introdotto su scala nazionale, studiato e costruito in primis sulle esigenze delle aziende del territorio. Una vera e propria rivoluzione nel campo del riciclo dei rifiuti ceramici. Un esempio di cultura imprenditoriale che ha aperto una nuova era di cooperazione e aggregazione tra imprese.

## Focus on raw materials

The excellent quality of the materials and the best of Italian know-how are what make the difference at SIMAS. All the production processes follow the environmental policies which are based on specific control and test parameters. This is achieved through the use of advanced technologies and an accurate selection of materials and their disposal in order to guarantee greater quality and maximum protection of the environment in the broadest sense of the term, starting from the actual production areas.

## Disposal and recovery

In 2010, SIMAS was one of the first companies in the district of Civita Castellana to participate in the innovative plaster recovery plant of the Centro Ceramico Civitonico introduced nationally, and designed and built according to the requirements of local companies. A real revolution in the field of ceramic waste recycling, it is the example of an entrepreneurial

culture that has opened the doors to a new era of cooperation between companies.

## L'attention envers les matières premières

Le dénominateur commun chez Simas est la qualité extrême des matériaux et le talent du savoir-faire italien qui fait la différence. Notre production respecte les politiques environnementales tout le long du processus de production configuré sur des paramètres précis de contrôle et de vérification de chaque phase d'usinage. Nous utilisons des technologies avancées et une recherche précise sur les matériaux et leur élimination en vue de garantir au produit une qualité supérieure et de protéger au maximum l'environnement dans le sens le plus large du terme, en commençant par les lieux où se déroule la production.

## Élimination et récupération

Déjà en 2010 Simas, l'une des premières entreprises du district de Civita Castellana, a participé à l'installation novatrice de récupération du plâtre usé du Centre Céramique de Civita Castellana, reconnu à l'échelle nationale, étudié et construit en premier lieu pour les exigences des entreprises du territoire. C'est une véritable révolution dans le domaine du recyclage des déchets céramiques: un exemple de culture d'entreprise qui a donné naissance à une nouvelle ère de coopération et d'alliance entre les entreprises.

## Augenmerk auf Rohstoffe

Gemeinsamer Nenner für Simas ist die erstklassige Qualität der Rohstoffe und das italienische Können, die den Unterschied ausmachen. Die Produktion beachtet die Umweltpolitiken in gesamten Produktionsprozess und sieht präzise Kontrollparameter und Überprüfungen in jeder Herstellungsphase vor. Dafür werden fortschrittliche Technologie und eine aufmerksame Forschung an Materialien und ihrer Entsorgung eingesetzt, um das Produkt mit höchster Qualität auszustatten und dem Umweltschutz ausgehend vom Produktionsort in seiner weitreichendsten Form und Auslegung gerecht zu werden.

## Entsorgung und Wiederverwertung

Als eine der ersten Firmen in der Region um Civita Castellana nahm Simas bereits 2010 an der innovativen Anlage zur Gipswiederverwertung des Keramikzentrums der Region teil, die auf nationaler Ebene eingeführt wurde und als erstes basierend auf den Anforderungen der Betriebe in der Region entwickelt und konstruiert wurde. Eine wahre Revolution im Bereich der Wiederverwertung von Keramikabfall. Dieses Beispiel unternehmerischer Kultur hat eine neue Ära der Kooperation und des Zusammenhalts unter Firmen eingeleitet.

## Внимание сырью

Общим знаменателем в Simas является максимальное качество материалов и итальянское мастерство, которое делает разницу. Производство, с уважением относящееся к политике окружающей среды в ходе всего производственного процесса, заданное на четких параметрах контроля и проверки всех этапов обработки, при использовании передовых технологий и внимательного поиска материалов, а также их утилизации, в целях гарантии продукции лучшего качества и максимального внимания аспекту окружающей среды в самом широком смысле этого слова, начиная с мест, где осуществляется производственный процесс.

## Утилизация и сбор использованного материала

Уже в 2010 году Simas из числа первых компаний района Чивита Кастеллана принимала участие в инновационной системе по сбору отработавшего гипса Керамического Центра, реализованного на национальном уровне, разработанного и созданного, в первую очередь, в соответствии с требованиями предприятий территории. Настоящая революция в области переработки керамических отходов. Пример предпринимательской культуры, открывший новую эру сотрудничества и агрегации между предприятиями.

## Spazio Simas Milano

A Milano, capitale del design, dal 2005 Simas ha un proprio Spazio, in via Melzo 9. Un open space dove la luce penetra a tutto campo e dove è possibile visionare le collezioni e aggiornarsi sull'ampia gamma di prodotti. Specificatamente dedicato ad architetti e progettisti, si presta, al tempo stesso, a incontri di lavoro, anche con i clienti, a seminari e a laboratori.

## Simas concept stands

Le presenze fieristiche di Simas nel mondo sono palcoscenici dal grafismo lineare, curati nei minimi dettagli. Un impegno notevole che vede l'apporto di partner leader, per comunicare al meglio i prodotti, in modo funzionale ed emozionale, e le tendenze più attuali del mondo dell'arredo e del design.

## Simas Space, Milan

In Milan, the capital of design, Simas has had its own space since 2005, in number 9 of Via Melzo. An open space where light comes in from all sides, and where visitors can view the collections and a wide range of products. Specifically dedicated to architects and designers, it is simultaneously perfect for work meetings with clients, for seminars, and workshops.

## Simas concept stands

Simas's presence in trade shows is marked by linear graphics, thought out in their smallest details. An effort that has led to awards in important events and that often includes associations with leading partners, to communicate in a functional and emotional manner the most up-to-date trends of the world of furnishing and of design.

## Espace Simas Milan

À Milan, capitale du design, Simas dispose depuis 2005 de son propre espace situé au 9 Via Melzo. Un open space où la lumière pénètre sans limite et où il est possible de découvrir les collections et les nouveautés de la vaste gamme de produits. Spécialement dédié aux architectes et aux designers, cet espace se prête également aux réunions d'affaires, également avec des clients, aux séminaires et aux ateliers.

## Simas concept stands

Les présences de Simas dans les différents salons sont mises en scène par un graphisme linéaire, soigné dans les moindres détails. Un engagement qui a conduit à l'attribution de prix dans le cadre d'importants événements, prévoyant le plus souvent l'apport de partenaires de renom afin de communiquer de façon fonctionnelle et émotionnelle les dernières tendances du monde du meuble et du design.

## Simas Showroom in Mailand

Seit 2005 hat Simas in Mailand, der Hauptstadt des Designs, einen eigenen Showroom in Via Melzo 9. Ein Open Space, in dem das Licht bis in jeden

Winkel dringt, wo der Besucher die Kollektionen ansehen und sich über das gesamte Produktangebot informieren kann. Speziell für Architekten und Planer gedacht eignet sich die Räumlichkeit auch für Geschäftstreffen, Kundengespräche, Seminare und Workshops.

## Konzeptstände von Simas

Simas ist auf den Messen der Welt vertreten, um die bis ins kleinste Detail durchdachten, linearen Formen zu präsentieren. Ein Engagement, das dem Unternehmen auf bedeutenden Messeveranstaltungen zahlreiche Auszeichnungen eingebracht hat und häufig auf der Zusammenarbeit mit führenden Partnerunternehmen beruht, um eine funktionale und emotionale Kommunikation der aktuellen Einrichtungs- und Designer-Trends zu ermöglichen.

## Площади Simas в Милане

В 2005 года в столице итальянского и мирового дизайна Милане на улице Мелцо 9 (via Melzo 9) Simas открыл собственный демонстрационный зал «Spazio». Помещение представляет собой единое открытое пространство, в котором можно увидеть текущие коллекции и новинки. Предназначенный в первую очередь для архитекторов и дизайнеров интерьеров, может служить местом встреч специалистов с заказчиками, а также для организации семинаров и мастер-классов.

## Концепт-стенды Simas

На всех международных ярмарках концепт-стенды Simas выделяет особая театрализованная графика, где каждая деталь несет свою смысловую нагрузку. Такие стенды зачастую организуются совместно с партнером-лидером и заслуженно отмечаются премиями. Функциональным и одновременно эмоциональным языком они рассказывают о новейших трендах в мире интерьеров и обстановке жилищ.

# SIMAS ACQUA SPACES

Commitment to brand image





# Italian CUL TURE

Powered by Simas

Dalle mostre culturali in Triennale a Milano alla sponsorizzazione dal 2005 di Poli.Design - Consorzio del Politecnico di Milano

From cultural exhibitions in the Triennial in Milan to the sponsoring of Poli.Design – Consortium of the Politecnico di Milano, since 2005

Depuis la première édition de 2005, Simas est aussi le sponsor académique de Poli.Design – Consortium du Polytechnique de Milan

Des expositions culturelles organisées tous les trois ans à Milan au parrainage, en 2005, de Poli.Design - Concours de l'École Polytechnique de Milan

От экспозиций на Триеннале в Милане до спонсирования, начиная с 2005 года, Poli.Design – Консорциума Политехнического университета Милана

# simas

## DESIGN

- 14** - E-line
- 30** - LFT Spazio
- 56** - Vignoni
- 82** - Baden Baden
- 108** - Flow
- 140** - Frozen
- 162** - Sharp
- 178** - Frame

## CLASSIC

- 192** - Arcade
- 242** - Lante
- 270** - Londra
- 294** - Evolution
- 314** - Vasche / Bathtubs
- 330** - Accessori / Accessories

## LAVABI D'ARREDO

- 342** - Vanity basins

## PIATTI DOCCIA

- 368** - Shower trays

## INFO

- 376** - Linea di colori / Colors
- Finiture / Finishing
- Condizioni generali / General sales terms



# e-line

DESIGN: TERRI PECORA

E-Line è la risposta light price tutta italiana di Simas alle nuove richieste di un mercato in continuo cambiamento. Una linea di ottima qualità a un prezzo decisamente accessibile, progettata per le nuove costruzioni e per le ristrutturazioni. Una serie di prodotti nati per supportare concretamente la domanda in trasformazione dell'edilizia residenziale e degli spazi pubblici.

E-Line by Simas, a light price Italian style A design especially created to satisfy the specific requirements of a market shaped by the social evolution and economy which have transformed the needs and life-styles of today's families and the spaces they inhabit. A fair price, aimed at satisfying the needs of a wider customer base.

E-Line est la réponse de SIMAS aux demandes émergentes d'un marché en mouvement continu. Une ligne d'excellente qualité résolument accessible en termes de prix pensée pour les nouvelles constructions et les rénovations. Une série de produits conçus pour supporter concrètement la demande en mutation du bâtiment résidentiel et public.

E-Line ist die ganz italienische Light Price- Antwort von Simas auf die neuen Herausforderungen eines Marktes im ständigen Wandel. Eine Kollektion ausgezeichneter Qualität zu einem durchaus erschwinglichen Preis, die für Neubauten und für Altbausanierungen entworfen worden ist. Eine Produktserie, die dazu bestimmt ist, die sich wandelnde Nachfrage des öffentlichen und privaten Wohnbaus konkret zu unterstützen.

E-Line – это бюджетный ответ Simas на новые запросы постоянного меняющегося рынка. Коллекция высокого качества по доступной цене, созданная для комплектации объектов как нового строительства, так и для реконструкций. Линия продукции, спроектированная для удовлетворения меняющегося спроса частного и общественного строительства.



EL 05 65x47x18



EL 10 65x48x19



EL 11 90x48x19



EL 19 35x51x25



EL 18 35x51x25



EL 04 35x51x41,5



EL 01 35x51x41,5



EL 07 35,5x62x42  
EL 09 35,5x13,5x42,5



CT 09 42x13,5x100,5

# estetica minimale e "light price".

Minimalist aesthetic and "light price".  
Esthétique minimaliste et «prix accessible».  
Minimalistische Ästhetik und "Licht Preis".  
минималистский эстетическое и "цена доступным".



**< EL 18**  
Vaso sospeso  
Wall hung WC

**< EL 19**  
Bidet sospeso  
Wall hung bidet



**<< EL 11**  
Consolle  
Console



**EL 11**

Consolle 90 da appoggio o sospesa  
 Counter top or wall hung console 90  
 Console 90 d'appui ou suspendue  
 Konsole 90, Aufsatz oder wandhängend  
 Консоль 90 подвесная или опорная

**EL 10**

Lavabo 65 appoggio o sospeso  
 Counter top or wall hung washbasin 65  
 Lavabo 65 d'appui ou suspendu  
 Waschtisch 65 wandhängend oder stehend  
 Умывальник 65 подвесной или опорный



**EL 05**

Lavabo 65 monoforo sospeso o su colonna  
 Washbasin 65 with single tap hole  
 wall hung or on pedestal  
 Lavabo 65 mono trou suspendu  
 ou sur colonne  
 Waschbecken 65, für Einlocharmatur,  
 wandhängend oder auf Säule  
 Умывальник 65 с одним отверстием,  
 подвесной или на колонне

**CN 200**

Colonna  
 Pedestal  
 Colonne  
 Säule  
 Колонна

**EL 18**

Vaso sospeso. Completo di set di fissaggio F 85  
 Wall hung WC. Complete with fixing set F 85  
 Cuvette suspendue. Complet de set de fixation F 85  
 Hänge-WC. Inklusive Befestigungsset F 85  
 Унитаз подвесной вместе с крепежным комплектом F 85

**EL 19**

Bidet sospeso monoforo. Completo di set di fissaggio F 85  
 Wall hung bidet with single tap hole. Complete with fixing set F 85  
 Bidet suspendu mono trou. Complet de set de fixation F 85  
 Hänge-Bidet, Einloch. Inklusive Befestigungsset F 85  
 Биде подвесное с одним отверстием. Комплектуется набором крепежей F 85



**ACCESSORI DI COMPLETAMENTO**  
**ACCESSORIES AVAILABLE**

**EL 003** Coprivaso avvolgente in  
 termoindurente con cerniere cromo  
 Wrap-around thermoset toilet seat with  
 chrome-finish hinges

**EL 004** Coprivaso avvolgente in  
 termoindurente con cerniere rallentate cromo  
 Wrap-around thermoset toilet seat with  
 chrome-finish soft-closing hinges

**EL 04**

Bidet monoforo carenato  
 Back to wall bidet with single tap hole  
 Bidet mono trou caréné  
 Bidet, Einloch, verkleidet  
 Биде приставное с одним отверстием

**EL 01**

Vaso carenato con scarico parete o pavimento  
 Back to wall WC with wall or floor outlet  
 Cuvette carénée décharge au mur ou au sol  
 WC, verkleidet. Wand- oder Bodenanschluss  
 Унитаз приставной. Горизонтальный или вертикальный слив

**ACCESSORI DI COMPLETAMENTO**  
**ACCESSORIES AVAILABLE**

**EL 003** Coprivaso avvolgente in termoindurente con cerniere cromo  
 Wrap-around thermoset toilet seat with chrome-finish hinges  
**EL 004** Coprivaso avvolgente in termoindurente con cerniere rallentate cromo  
 Wrap-around thermoset toilet seat with chrome-finish soft-closing hinges

**EL 07**

Vaso monoblocco carenato con scarico a parete o pavimento  
 Back to wall close coupled WC with wall or floor outlet  
 Cuvette mono bloc carénée avec décharge au mur ou au sol  
 Monoblock-WC, verkleidet. Wand-oder Bodenanschluss  
 Унитаз моноблок. Горизонтальный или вертикальный слив

**EL 09**

Cassetta con coperchio per vaso monoblocco  
 Cistern with lid for close coupled WC  
 Réservoir avec couvercle pour cuvette mono bloc  
 Monoblock-Spülkasten  
 Бачок с крышкой для моноблока



**ACCESSORI DI COMPLETAMENTO**  
**ACCESSORIES AVAILABLE**

**EL 003** Coprivaso avvolgente in termoindurente con cerniere cromo  
 Wrap-around thermoset toilet seat with chrome-finish hinges  
**EL 004** Coprivaso avvolgente in termoindurente con cerniere rallentate cromo  
 Wrap-around thermoset toilet seat with chrome-finish soft-closing hinges  
**D 22** Batteria di scarico doppio flusso cromo per cassetta monoblocco  
 Push button double flush mechanism in chrome-finish for close coupled cistern

**EL 10**

kg 18

Lavabo 65 da appoggio o sospeso predisposto monoforo

Counter top or wall hung washbasin 65 pre-punched for single tap hole

Lavabo 65 d'appui ou suspendu prédisposé mono trou

Waschbecken 65, Aufsatz oder wandhängend, für Einlocharmatur

Раковина 65 с одним намеченным отверстием подвесная

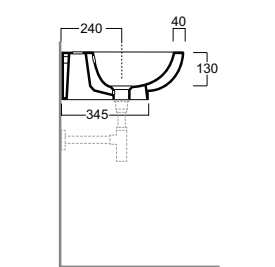
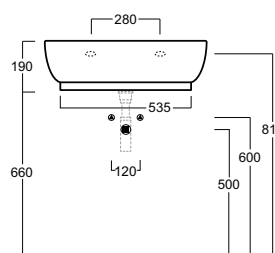
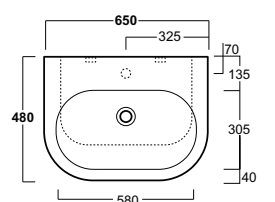
**EL 11**

kg 22

Consolle 90 da appoggio o sospesa predisposto monoforo

Counter top or wall hung console 90 pre-punched for single tap hole

Consolle 90 d'appui ou suspendue prédisposé mono trou

Konsole 90, Aufsatz oder wandhängend, für Einlocharmatur

Консоль 90 опорная или подвесная, предусмотрено одно отверстие

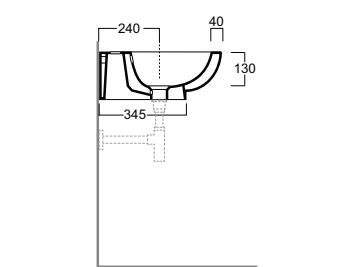
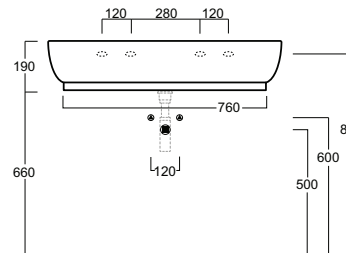
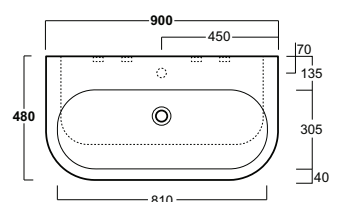
**EL 05**

kg 19

Lavabo 65 monoforo sospeso o su colonna

Washbasin 65 with single tap hole wall hung or on pedestal

Lavabo 65 mono trou suspendu ou sur colonne

Waschbecken 65, für Einlocharmatur, wandhängend oder auf Säule

Раковина 65 с одним отверстием подвесная или с установкой на пьедестал

**CN 200**

Kg 11

Colonna  
Pedestal  
Colonne  
Säule  
Колонна

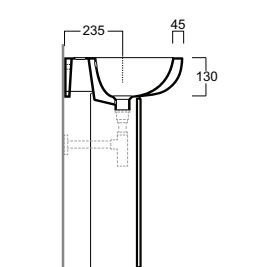
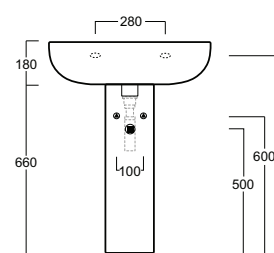
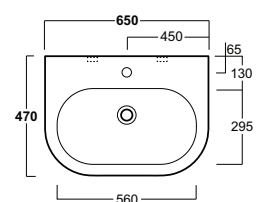
**EL 04**

kg 19

Bidet monoforo carenato

Back to wall bidet with single tap hole

Bidet mono trou caréné

Bidet, Einloch, verkleidet

Биде с одним отверстием, обтекаемой формы

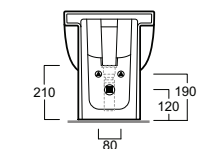
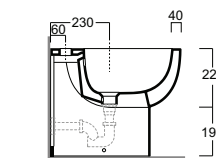
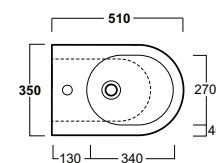
**EL 01**

kg 22

Vaso carenato. Scarico parete o pavimento (curva tecnica inclusa)

Back to wall WC. Wall or floor outlet (curved pipe included)

Cuvette carénée. Décharge au mur ou au sol (courbe technique incluse)

WC, verkleidet. Wand- oder Bodenanschluss (Inklusive Bogenrohr)

Унитаз обтекаемой формы. Слив на стене или полу (в комплекте с коленом)

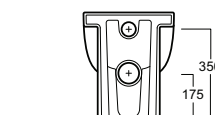
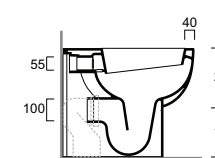
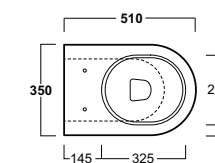
**CT 09 / D 20**

kg 23

Cassetta monoblocco con batteria di scarico. Per vaso EL 01 / LFT 20 / VI 01 / BB 01 / FL 61

Close coupled cistern with flush mechanism. For WC EL 01 / LFT 20 / VI 01 / BB 01 / FL 61

Caisse mono bloc avec batterie de décharge. Pour cuvette EL 01 / LFT 20 / VI 01 / BB 01 / FL 61

Monoblock-Spülkasten mit Abflussmechanik. Für WC EL 01 / LFT 20 / VI 01 / BB 01 / FL 61

Бачок моноблок с механизмом слива и специальным набором крепежей. Для унитазов EL 01 / LFT 20 / VI 01 / BB 01 / FL 61

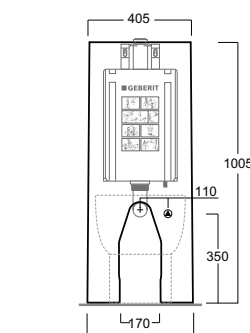
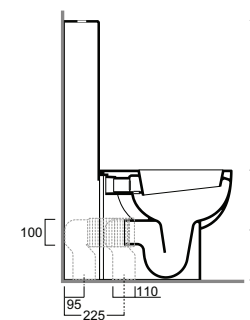
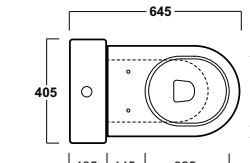

**EL 07**

kg 25

Vaso monoblocco carenato con scarico a parete o pavimento (curva tecnica inclusa)

*Back to wall close coupled WC with wall or floor outlet (curved pipe included)*

*Cuvette monobloc carénée avec décharge au mur ou au sol (courbe technique incluse)*

*Monoblock-WC, verkleidet. Wand- oder Bodenanschluss (Inklusive Bogenrohr)*

*Унитаз моноблок. Горизонтальный или вертикальный слив (техническое колено включено в комплектацию)*

**D 22**

kg 1

Batteria di scarico doppio flusso cromo per cassetta monoblocco

*Push button double flush mechanism in chrome-finish for close coupled cistern*

*Mécanisme de chasse, double chasse, avec bouton chromé pour réservoir monobloc*

*Spülung, 2-Mengen-Spülung mit WC-Taste in Chrom für Komplett-Spülkasten*

*Механизм слива с двойным потоком хромированный для моноблочного бачка*

**EL 19 / F 85**

kg 15

Bidet monoforo sospeso. Completo di set di fissaggio F 85

*Wall hung bidet with single tap hole. Complete with fixing set F 85*

*Bidet mono trou suspendu. Complet de set de fixation F 85*

*Hänge-Bidet, Einloch. Inklusive Befestigungsset F 85*

*Биде с одним отверстием, подвесное, вместе с крепежным комплектом F 85*

**EL 18 / F 85**

kg 18

Vaso sospeso. Completo di set di fissaggio F 85

*Wall hung WC. Complete with fixing set F 85*

*Cuvette suspendue. Complet de set de fixation F 85*

*Hänge-WC. Inklusive Befestigungsset F 85*

*Унитаз подвесной вместе с крепежным комплектом F 85*

**EL 003**

kg 2,6

Coprivaso avvolgente in termoindurente cerniere cromo

*Wrap-around thermoset toilet seat with chrome-finish hinges*

*Abattant en thermo durcisseur charnières chrome*

*WC Deckel, thermoverformt, Chromscharniere*

*Крышка для унитаза из термореактопласта, с хромированными шарнирными петлями*

**F 89**

kg 0,18

Set viti di fissaggio per lavabo

*Set fixing screws for washbasin*

*Set de vis de fixation pour lavabo*

*Montageset Waschbecken*

*Комплект крепежных винтов для раковины*

**EL 09**

Kg 11

Cassetta con coperchio per vaso monoblocco

*Cistern with lid for close coupled WC*

*Réservoir avec couvercle pour cuvette mono bloc*

*Monoblock-Spülkasten*

*Бачок с крышкой для моноблока*

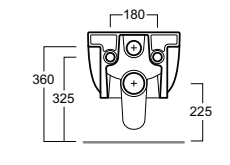
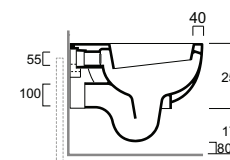
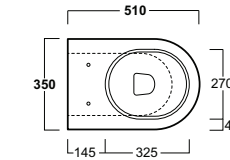
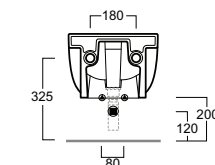
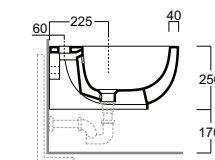
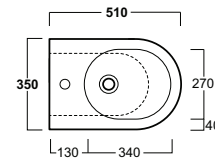
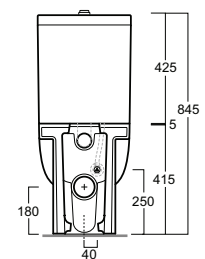
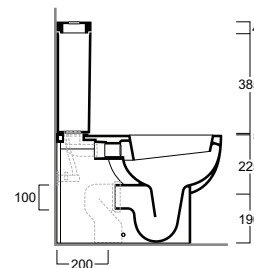
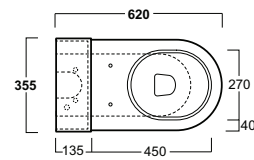
**EL 004**

kg 2,6

Coprivaso avvolgente in termoindurente con cerniere rallentate cromo

*Wrap-around thermoset toilet seat with chrome-finish soft-closing hinges*

*Abattant enveloppant en thermo durcisseur avec des charnières ralenties chrome*

*WC Deckel, thermoverformt, Chromscharniere mit Absenkautomatik*

*Крышка для унитаза из термореактопласта с хромированными шарнирными петлями с механизмом плавного опускания*

**F 88**

kg 0,12

Set viti di fissaggio laterali cromo/bianco per vaso o bidet

*Set of chrome/white lateral fixing screws for wc or bidet*

*Set de vis de fixation latérales chromées/blanc pour WC ou bidet*

*Montageset seitliche Montage weiss/chrom für WC oder Bidet*

*Комплект боковых крепежных винтов хром/белый для унитаза или биде*



**F 84**

kg 3

Coppia staffe di fissaggio per vaso o bidet sospesi

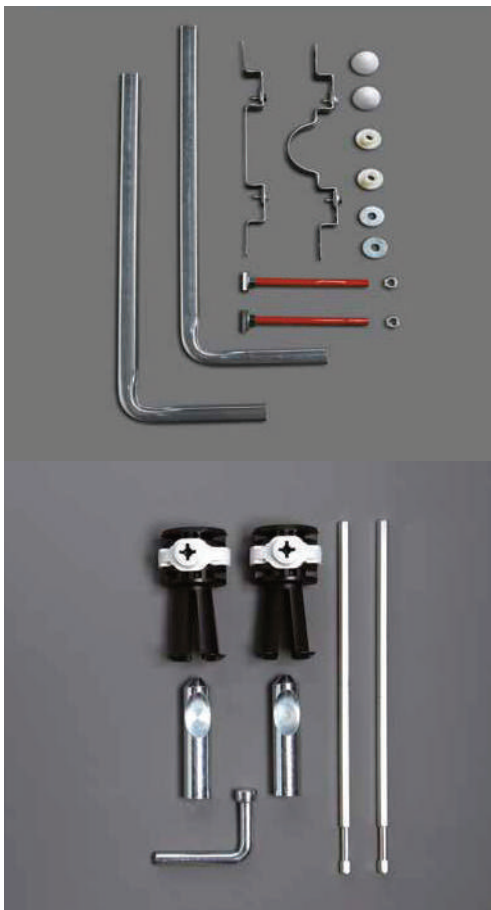
*A pair of brackets for wall hung wc or bidet**Paire d'équerres de fixation pour cuvette ou bidet suspendus**Paar Befestigungshalterungen für Wandklosett oder Wandbidets**Пара крепёжных скоб для подвесных унитаза или биде***F 85**

kg 0,3

Set viti fissaggio a completamento staffe F 84 per vaso o bidet sospesi

*Fixing Kit for F 84 brackets for wall hung WC or bidet**Jeu de vis de fixation pour équerre F 84 pour cuvette ou bidet suspendu**Satz Befestigungsschrauben zur Ergänzung der Halterungen F 84 Wandklosett oder Wandbidet**Комплект крепежных винтов для комплектования скоб F 84 для подвесного унитаза или биде***SIF 165**

kg 1,1

Sifone cilindrico lavabo da 1 1/4"

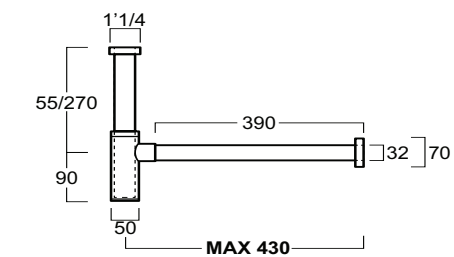
*Cylindrical trap for washbasin 1 1/4"**Siphon cylindrique pour lavabo de 1 1/4"**Siphon, zylindrisch für Waschbecken 1 1/4"**Сифон цилиндрической формы для раковин***SIF 270**

kg 1,4

Sifone cilindrico lavabo da 1 1/4"

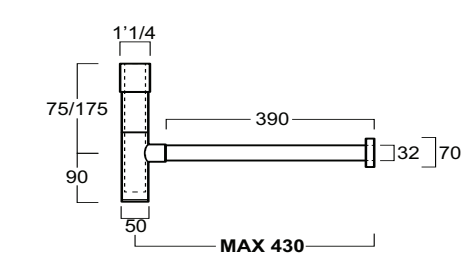
*Cylindrical trap for washbasin 1 1/4"**Siphon cylindrique pour lavabo de 1 1/4"**Siphon, zylindrisch für Waschbecken 1 1/4"**Сифон цилиндрической формы для раковин***SIF 125**

kg 1

Sifone cilindrico per bidet da 1 1/4"

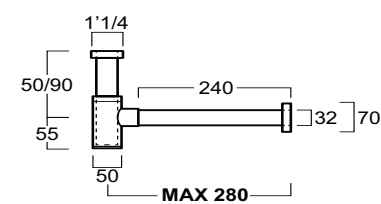
*Cylindrical trap for bidet 1 1/4"**Siphon cylindrique pour bidet de 1 1/4"**Siphon, zylindrisch für Bidet 1 1/4"**Цилиндрический сифон для биде 1 1/4"***PLCR**

kg 0,4

Piletta "shut rapid" o "free flow" cromo

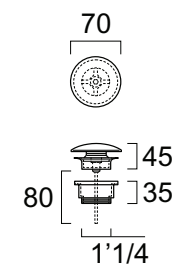
*Pop-up waste "shut rapid" or "free flow" chrome**Bonde "shut rapid" ou "free flow" chromée**Abflusstöpsel "Shut rapid" oder "free flow" chrom**Донный клапан типа "быстрый затвор" или "свободный поток" хром***PLCE**

kg 0,5

Piletta "shut rapid" o "free flow" in ceramica

*Pop-up waste "shut rapid" or "free flow" ceramic**Bonde "shut rapid" ou "free flow" céramique**Abflusstöpsel "Shut rapid" oder "free flow" keramik**Донный клапан типа "быстрый затвор" или "свободный поток" керамика*

\* Disponibile in tutti i colori

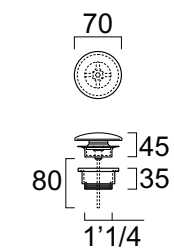
*Available in all colors**Disponibile dans tous les coloris**Verfuegbar in alle die Farben**В наличии все цвета.*



# lft spazio

DESIGN: TERRI PECORA

Il piacere di un progetto amico.

Una collezione essenziale nella forma pulita, in nome di un nuovo concetto di geometria che si spinge nel super-ovale. Adattabile agli spazi moderni e architettonici e al bagno più intimo e quotidiano. Indossa con leggerezza la semplicità delle linee, in una risposta giovane e versatile, accessibile a tutti. Nella collezione anche la piccola gamma di mobili, in rovere e laccature colorate.

A project almost as good as your best friend.

An essential collection based on clean shapes, styled in a new geometric framework which is based on the super-oval. Adaptable to modern interiors and architectural spaces, perfect for an intimate or everyday bathroom. Accessible to all, LFT spazio is weightless and simple, young and versatile. A small collection of furniture is also available in oak and coloured lacquer.

Le plaisir d'un projet ami.

Une collection essentielle dans une forme propre, au nom d'un nouveau concept de géométrie qui se pousse dans un super ovale. Adaptable aux espaces modernes et architectoniques et à la salle de bain plus intime et quotidien. Il se vêt avec une légèreté et une simplicité des lignes, dans une réponse jeune et versatile, accessible à tous. Dans la collection aussi la petite gamme de meuble, en rouvre et laquage coloré. Ein freundliches Projekt.

Eine essentielle und in den Formen reduzierte Kollektion. Ein Konzept das auf der Betonung des Ovalen basiert. Ideal für moderne, architektonische Ambiente wie das vertraute, alltägliche Badezimmer. Mit Leichtigkeit werden einfache Linien gezogen, die sich als jugendlich und frisch erweisen und jedem offen stehen. Zur Kollektion passend Möbel in Eiche und Assecoires, farbig lackiert.

Исключительная коллекция с точки зрения чистоты форм, новая геометрическая концепция, тяготеющая к суперовалу. Подходит как для современных архитектурных помещений, и для ванных комнат более интимных и повседневных. Легкость и простота линий, свежесть и многогранность, подойдет для любого вкуса. В коллекции есть также небольшая гамма мебели из дуба и с цветным лаковым покрытием.



LFT 05 65,5x51x16

LFT 24 60x44x17,5

LFT 34 73x45,5x17,5

LFT 64 63x33x17,5

LFT 74 66x39x24



LFT 54 61x39x17,5

LFT 44 80x50x20,5



LFT 25 35x63x42,5  
LFT 26 29x13,5x41,5



LFT 20 34x53x42

LFT 21 34x53x42

LFT 18 35x52x25

LFT 19 35x52x25

CT 09 42x13,5x100,5

# la leggerezza e la semplicità delle linee.

The lightness and simplicity of the lines.  
La légèreté et simplicité des lignes.  
Die Leichtigkeit und Schlichtheit der Linien.  
Легкость и простота линий.

> **LFT 44**  
Consolle 80  
Console 80



< **LFT A1**  
Porta asciugamani frontale  
Anterior towel rail

> **LFT 18**  
Vaso sospeso  
Wall hung WC



< **LFT 19**  
Bidet sospeso  
Wall hung Bidet



**LFT 34**

Lavabo ovale 73 da appoggio o sospeso  
*Oval counter top or wall hung washbasin 73*  
 Lavabo ovale 73 d'appui o suspendu  
*Ovaler Waschtisch 73 stehend oder wandhängend*  
 Раковина овальная 73 накладная или подвесная  
 с одним намеченным отверстием

**LFT A5**

Porta asciugamani frontale cromato per LFT 34  
*Chrome-finish anterior towel rail for LFT 34*  
 Porte serviette frontale chromée pour LFT 34  
*Handtuchhalter, frontseitig, chrom für LFT 34*  
 Фронтальная хромированная полка для  
 полотенец для LFT 34



**ACCESSORI DI COMPLETAMENTO**  
**ACCESSORIES AVAILABLE**

**LFT A5** Portasciugamani frontale  
*Anterior towel rail*

**LFT 24**

Lavabo 60 da appoggio o sospeso  
*Counter top or wall hung washbasin 60*  
 Lavabo 60 d'appui ou suspendu  
*Waschtisch 60 stehend oder wandhängend*  
 Раковина 60 накладная или подвесная с  
 одним намеченным отверстием



**ACCESSORI DI COMPLETAMENTO**  
**ACCESSORIES AVAILABLE**

**LFT A4** Portasciugamani frontale  
*Anterior towel rail*

**LFT 64**

Lavabo 63 da appoggio  
Counter top washbasin 63  
Lavabo 63 d'appui  
Aufsatzwaschbecken 63  
Раковина 63 накладная

**LFT 44**

Consolle 80 sospesa  
Wall hung console 80  
Console 80 suspendue  
Konsole 80 wandhängend  
Консоль 80 прямоугольная

**LFT A3**

Porta asciugamani frontale cromato per LFT 44  
Chrome-finish anterior towel rail for LFT 44  
Porte serviette frontale chromée pour LFT 44  
Handtuchhalter, frontseitig, chrom für LFT 44  
Фронтальная хромированная полка для полотенец для LFT 44



ACCESSORI DI COMPLEMENTAMENTO  
ACCESSORIES AVAILABLE

**LFT A1** Portasciugamani frontale  
Anterior towel rail  
**LFT A3** Portasciugamani laterale  
Side towel rail

**LFT 54**

Lavabo 61 rettangolare da appoggio o sospeso  
 Rectangular counter top or wall hung washbasin 61  
 Lavabo 61 rectangulaire d'appui ou suspendu  
 Waschtisch 61 rechteckig stehend oder wandhängend  
 Раковина 61 прямоугольная накладная либо подвесная  
 с одним намеченным отверстием



**ACCESSORI DI COMPLETAMENTO**  
**ACCESSORIES AVAILABLE**

**LFT A2** Portasciugamani frontale  
 Anterior towel rail

**LFT 05**

Lavabo 65 sospeso o su colonna  
 Washbasin 65 wall hung or on pedestal  
 Lavabo 65 mono trou suspendu ou sur colonne  
 Waschbecken 65, für Einlocharmatur, wandhängend oder auf Säule  
 Раковина 65 с одним отверстием подвесная либо на пьедестале

**CN 200**

Colonna  
 Pedestal  
 Colonne  
 Säule  
 Колонна

**ACCESSORI DI COMPLETAMENTO**  
**ACCESSORIES AVAILABLE**

**CN 200** Colonna  
 Pedestal

**LFT 74**

Lavabo sottopiano  
 Under-counter washbasin  
 Lavabo sous étage  
 Unterbauwaschbecken  
 Умывальник, устанавливаемый ниже  
 опорной поверхности

**LFT 19**

Bidet sospeso monoforo. Completo di set di fissaggio F 85  
 Wall hung bidet with single tap hole. Complete with fixing set F 85  
 Bidet suspendu mono trou. Complet de set de fixation F 85  
 Hänge-Bidet, Einloch. Inklusive Befestigungsset F 85  
 Биде подвесное с одним отверстием. Комплектуется набором крепежей F 85

**LFT 18**

Vaso sospeso. Completo di set di fissaggio F 85  
 Wall hung WC. Complete with fixing set F 85  
 Cuvette suspendue. Complet de set de fixation F 85  
 Hänge-WC. Inklusive Befestigungsset F 85  
 Унитаз подвесной вместе с крепежным комплектом F 85

.....  
**ACCESSORI DI COMPLETAMENTO**  
**ACCESSORIES AVAILABLE**

**LFT 005** Coprivaso in termoindurente con cerniere cromo  
 Thermoset toilet seat with chrome-finish hinges  
**LFT 006** Coprivaso in termoindurente con cerniere rallentate cromo  
 Thermoset toilet seat with chrome-finish soft-closing hinges



**LFT 21**

Bidet monoforo carenato  
*Back to wall bidet with single tap hole*  
*Bidet mono trou caréné*  
*Bidet, Einloch, verkleidet*  
*Биде приставное с одним отверстием*

**LFT 20**

Vaso carenato con scarico parete o pavimento  
*Back to wall WC with wall or floor outlet*  
*Cuvette carénée décharge au mur ou au sol*  
*WC, verkleidet. Wand- oder Bodenanschluss*  
*Унитаз приставной. Горизонтальный или вертикальный слив*

**ACCESSORI DI COMPLETAMENTO**  
**ACCESSORIES AVAILABLE**

**LFT 005** Coprivaso in termoindurente con cerniere cromo  
*Thermoset toilet seat with chrome-finish hinges*

**LFT 006** Coprivaso in termoindurente con cerniere rallentate cromo  
*Thermoset toilet seat with chrome-finish soft-closing hinges*

**LFT 20**

Vaso carenato con scarico parete o pavimento  
*Back to wall WC with wall or floor outlet*  
*Cuvette carénée décharge au mur ou au sol*  
*WC, verkleidet. Wand- oder Bodenanschluss*  
*Унитаз приставной. Горизонтальный или вертикальный слив*

**CT 09 / D 20**

Cassetta monoblocco con batteria di scarico e apposito set di fissaggio  
*Close coupled cistern with flush mechanism and special fixing set*  
*Caisse mono bloc avec batterie de décharge et spécial kit de fixation*  
*Monoblock-Spülkasten mit Abflussmechanik und Befestigungsset*  
*Бачок моноблок с механизмом слива и специальным набором крепежей*

**ACCESSORI DI COMPLETAMENTO**  
**ACCESSORIES AVAILABLE**

**LFT 005** Coprivaso in termoindurente con cerniere cromo  
*Thermoset toilet seat with chrome-finish hinges*

**LFT 006** Coprivaso in termoindurente con cerniere rallentate cromo  
*Thermoset toilet seat with chrome-finish soft-closing hinges*



**LFT 25**

Vaso monoblocco carenato con scarico a parete o pavimento  
*Back to wall close coupled WC with wall or floor outlet*  
*Cuvette mono bloc carénée avec décharge au mur ou au sol*  
*Monoblock-WC, verkleidet. Wand-oder Bodenanschluss*  
*Унитаз моноблок. Горизонтальный или вертикальный слив*

**LFT 26**

Cassetta con coperchio per vaso monoblocco Base  
*Cistern with lid for close coupled WC Base*  
*Réservoir avec un couvercle pour cuvette mono bloc Base*  
*Monoblock-Spülkasten Base*  
*Бачок с крышкой для моноблока Base*



**ACCESSORI DI COMPLETAMENTO**  
**ACCESSORIES AVAILABLE**

**LFT 005** Coprivaso in termoindurente con cerniere cromo  
*Thermoset toilet seat with chrome-finish hinges*

**LFT 006** Coprivaso in termoindurente con cerniere rallentate cromo  
*Thermoset toilet seat with chrome-finish soft-closing hinges*

**D 22** Batteria di scarico doppio flusso cromo per cassetta monoblocco  
*Push button double flush mechanism in chrome-finish for close coupled cistern*



**LFT 05**

kg 18

Lavabo 65 monoforo sospeso o su colonna

*Washbasin 65 with single tap hole wall hung or on pedestal**Lavabo 65 mono trou suspendu ou sur colonne**Waschbecken 65, für Einlocharmatur, wandhängend oder auf Säule**Раковина 65 с одним отверстием, подвесной или на колонне***LFT 64**

kg 10

Lavabo 63 da appoggio

*Counter top washbasin 63**Lavabo 63 d'appui**Aufsatzwaschbecken 63**Раковина 63 накладная***LFT 24**

kg 14

Lavabo 60 da appoggio o sospeso predisposto monoforo

*Oval counter top or wall hung washbasin 60 pre-punched for single tap hole**Lavabo 60 d'appui ou suspendu prédisposé mono trou**Waschbecken 60, als Aufsatzwaschbecken oder wandhängend, für Einlocharmatur**Раковина 60 накладная или подвесная с одним намеченным отверстием***LFT 34**

kg 15

Lavabo ovale 73 da appoggio o sospeso predisposto monoforo

*Oval counter top or wall hung washbasin 73 pre-punched for single tap hole**Lavabo ovale 73 d'appui ou suspendu prédisposé mono trou**Waschbecken 73, oval, als Aufsatzwaschbecken oder wandhängend, für Einlocharmatur**Раковина овальная 73 накладная или подвесная с одним намеченным отверстием***LFT 54**

kg 20

Lavabo 61 rettangolare da appoggio o sospeso predisposto monoforo

*Rectangular counter top or wall hung washbasin 61 pre-punched for single tap hole**Lavabo 61 rettangolare d'appui ou suspendu prédisposé mono trou**Waschbecken 61, rechteckig, als Aufsatzwaschbecken oder wandhängend, für Einlocharmatur**Раковина 61 прямоугольная накладная либо подвесная с одним намеченным отверстием***LFT 44**

kg 22

Consolle 80 rettangolare sospesa predisposta monoforo

*Rectangular wall hung console 80 pre-punched for single tap hole**Console 80 rettangolare suspendue prédisposée mono trou**Konsole 80, rechteckig, wandhängend, für Einlocharmatur**Консоль 80 прямоугольная подвесная с одним намеченным отверстием***CN 200**

kg 11

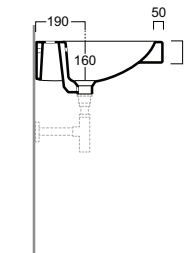
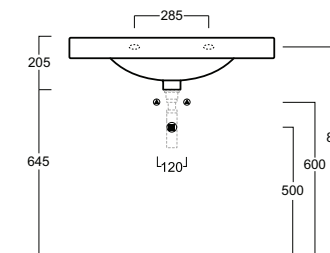
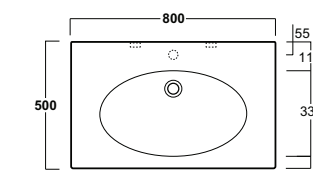
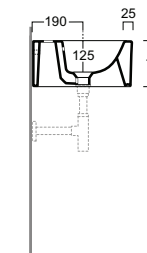
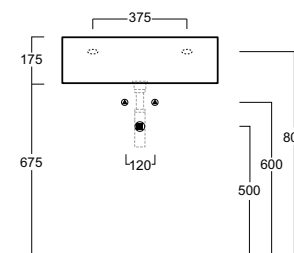
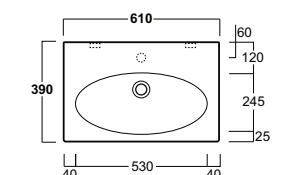
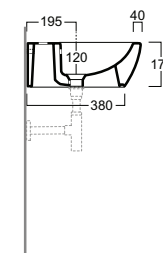
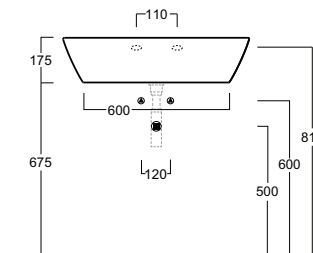
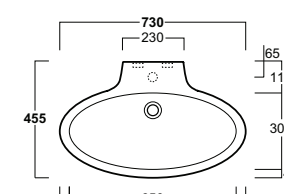
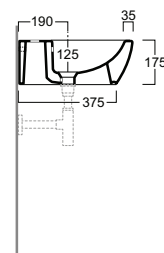
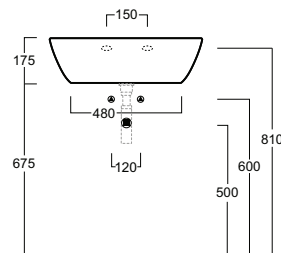
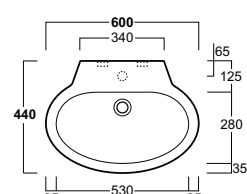
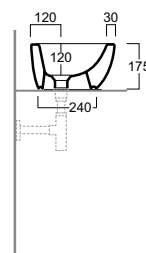
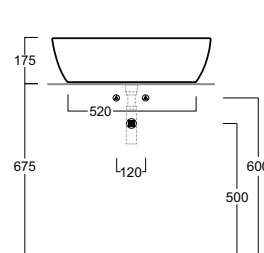
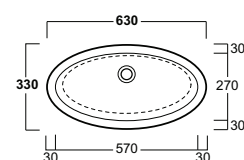
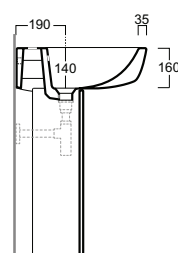
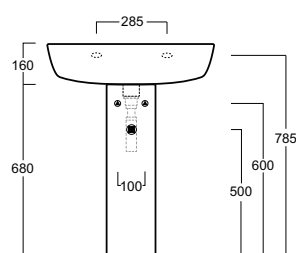
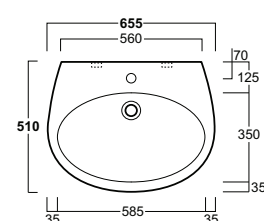
Colonna  
Pedestal  
Colonne  
Säule  
Колонна

**LFT 74**

kg 9

Lavabo sottopiano

*Under-counter washbasin*

Lavabo sous étage

Unterbauwaschbecken

Умывальник, устанавливаемый ниже опорной поверхности

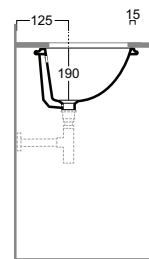
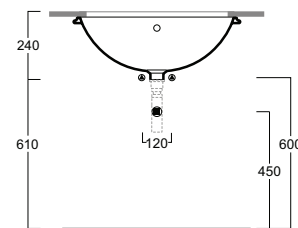
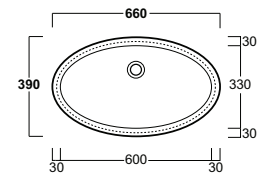
**LFT 21**

kg 14

Bidet monoforo carenato

*Back to wall bidet with single tap hole*

Bidet mono trou caréné

Bidet, Einloch, verkleidet

Биде приставное с одним отверстием

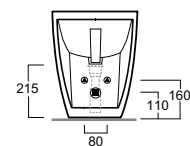
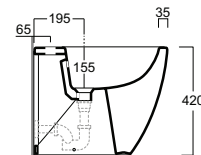
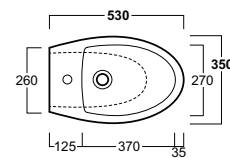
**LFT 20**

kg 21

Vaso carenato. Scarico parete o pavimento (curva tecnica inclusa)

*Back to wall WC. Wall or floor outlet (curved pipe included)*

Cuvette carénée. Décharge au mur ou au sol (courbe technique incluse)

WC, verkleidet. Wand- oder Bodenanschluss (Inklusive Bogenrohr)

Унитаз приставной. Горизонтальный или вертикальный слив (техническое колено включено в комплектацию). Бачок с крышкой

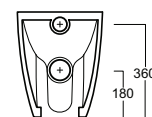
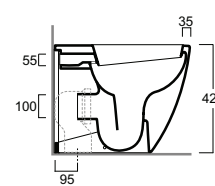
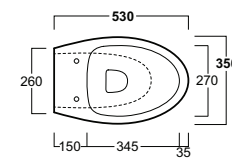
**CT 09 / D 20**

kg 23

Cassetta monoblocco con batteria di scarico. Per vaso EL 01 / LFT 20 / VI 01 / BB 01 / FL 61

*Close coupled cistern with flush mechanism. For WC EL 01 / LFT 20 / VI 01 / BB 01 / FL 61*

Caisse mono bloc avec batterie de décharge. Pour cuvette EL 01 / LFT 20 / VI 01 / BB 01 / FL 61

Monoblock-Spülkasten mit Abflussmechanik. Für WC EL 01 / LFT 20 / VI 01 / BB 01 / FL 61

Бачок моноблок с механизмом слива и специальным набором крепежей. Для унитазов EL 01 / LFT 20 / VI 01 / BB 01 / FL 61

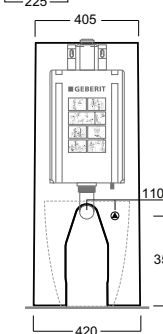
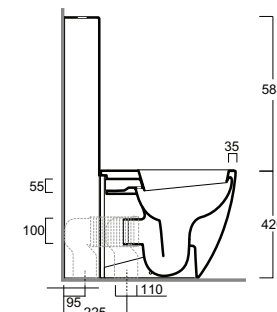
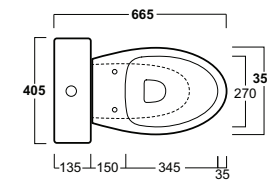
**LFT 19 / F 85**

kg 15

Bidet monoforo sospeso. Completo di set di fissaggio F 85

*Wall hung bidet with single tap hole. Complete with fixing set F 85*

Bidet mono trou suspendu. Complet de set de fixation F 85

Hänge-Bidet, Einloch. Inklusive Befestigungsset F 85

Биде подвесное с одним отверстием. Комплектуется набором крепежей F 85

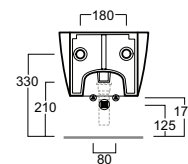
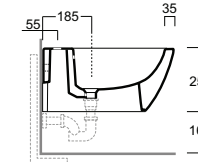
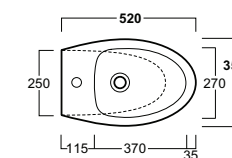
**LFT 18 / F 85**

kg 17

Vaso sospeso. Completo di set di fissaggio F 85

*Wall hung WC. Complete with fixing set F 85*

Cuvette suspendue. Complet de set de fixation F 85

Hänge-WC. Inklusive Befestigungsset F 85

Унитаз подвесной. Комплектуется набором крепежей F 85

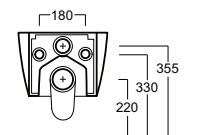
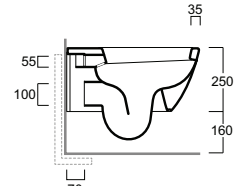
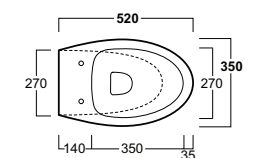

**LFT 25**

kg 28

Vaso monoblocco carenato Base con scarico a parete o pavimento (curva tecnica inclusa)

*Back to wall close coupled WC Base with wall or floor outlet (curved pipe included)*

*Cuvette monobloc carénée Base avec décharge au mur ou au sol (courbe technique incluse)*

*Monoblock-WC Base, verkleidet. Wand- oder Bodenanschluss (Inklusive Bogenrohr)*

*Унитаз моноблок Base. Горизонтальный или вертикальный слив (техническое колено включено в комплектацию)*

**LFT 26**

kg 9,5

Cassetta con coperchio per vaso monoblocco Base

*Cistern with lid for close coupled WC Base*

*Réservoir avec un couvercle pour cuvette mono bloc Base*

*Monoblock-Spülkasten Base*

*Бачок с крышкой для моноблока Base*

**LFT 005**

kg 2,6

Coprivaso in termoindurente cerniere cromo a sgancio rapido

*Thermoset toilet seat with chrome-finish hinges quick-release*

*Abattant en thermo durcisseur charnières chromées declipsables*

*WC Deckel, thermoverformt, Chromscharniere "quick-release"*

*Сиденье быстросъемное из терморезины с петлями хром*

**LFT A4**

kg 0,7

Portasciugamani frontale cromato per LFT 24

*Chrome-finish anterior towel rail for LFT 24*

*Porte serviette frontale chromée pour LFT 24*

*Handtuchhalter, frontseitig, chrom für LFT 24*

*Фронтальная хромированная полка для полотенец для LFT 24*

**LFT A5**

kg 0,7

Portasciugamani frontale cromato per LFT 34

*Chrome-finish anterior towel rail for LFT 34*

*Porte serviette frontale chromée pour LFT 34*

*Handtuchhalter, frontseitig, chrom für LFT 34*

*Фронтальная хромированная полка для полотенец для LFT 34*

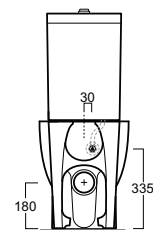
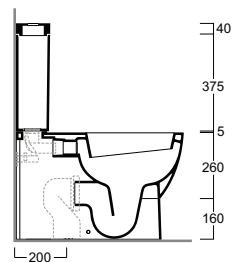
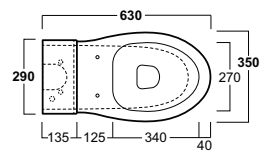
**LFT 006**

kg 2,6

Coprivaso in termoindurente con cerniere rallentate cromo a sgancio rapido

*Thermoset toilet seat with chrome-finish soft-closing hinges quick-release*

*Abattant enveloppant en thermo durcisseur avec charnières ralenties chromées declipsables*

*WC Deckel, thermoverformt, Chromscharniere mit Absenkautomatik quick-release*

*Сиденье с микролифтом быстросъемное из терморезины с петлями хром*

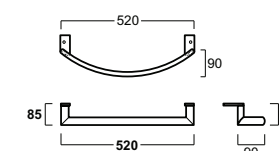
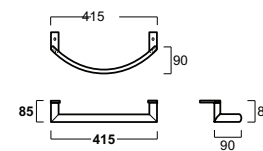

**LFT A2**

kg 0,8

Porta asciugamani frontale cromato per LFT 54  
 Chrome-finish anterior towel rail for LFT 54  
 Porte serviette frontale chromée pour LFT 54  
 Handtuchhalter, frontseitig, chrom für LFT 54  
 Фронтальная полка для LFT54

**LFT A1**

kg 0,7

Porta asciugamani frontale cromato per LFT 44  
 Chrome-finish anterior towel rail for LFT 44  
 Porte serviette frontale chromée pour LFT 44  
 Handtuchhalter, frontseitig, chrom für LFT 44  
 Фронтальная полка для LFT44

**LFT A3**

kg 0,7

Porta asciugamani laterale cromato per LFT 44  
 Chrome-finish side towel rail for LFT 44  
 Porte serviette latérale chromée pour LFT44  
 Handtuchhalter, seitlich, chrom für LFT44  
 Боковая полка для полотенец, хром для LFT 44

**F 89**

kg 0,18

Set viti di fissaggio per lavabo  
 Set fixing screws for washbasin  
 Set de vis de fixation pour lavabo  
 Montageset Waschbecken  
 Комплект крепежных винтов для раковины

**F 88**

kg 0,12

Set viti di fissaggio laterali cromo/bianco per vaso o bidet  
 Set of chrome/white lateral fixing screws for wc or bidet  
 Set de vis de fixation latérales chromées/blanc pour WC ou bidet  
 Montageset seitliche Montage weiss/chrom für WC oder Bidet  
 Комплект боковых крепежных винтов хром/белый для унитаза или биде

**F 84**

kg 3

Coppia staffe di fissaggio per vaso o bidet sospesi  
 A pair of brackets for wall hung wc or bidet  
 Paire d'équerres de fixation pour cuvette ou bidet suspendus  
 Paar Befestigungshalterungen für Wandklosett oder Wandbidets  
 Пара крепёжных скоб для подвесных унитаза или биде

**F 85**

kg 0,3

Set viti fissaggio a completamento staffe F 84 per vaso o bidet sospeso  
 Fixing Kit for F 84 brackets for wall hung WC or bidet  
 Jeu de vis de fixation pour équerre F 84 pour cuvette ou bidet suspendu  
 Satz Befestigungsschrauben zur Ergänzung der Halterungen F 84 Wandklosett oder Wandbidet  
 Комплект крепежных винтов для комплектования скоб F 84 для подвесного унитаза или биде

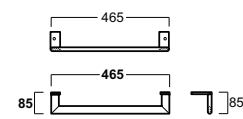
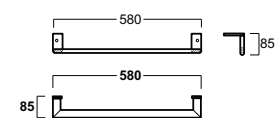
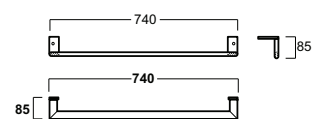
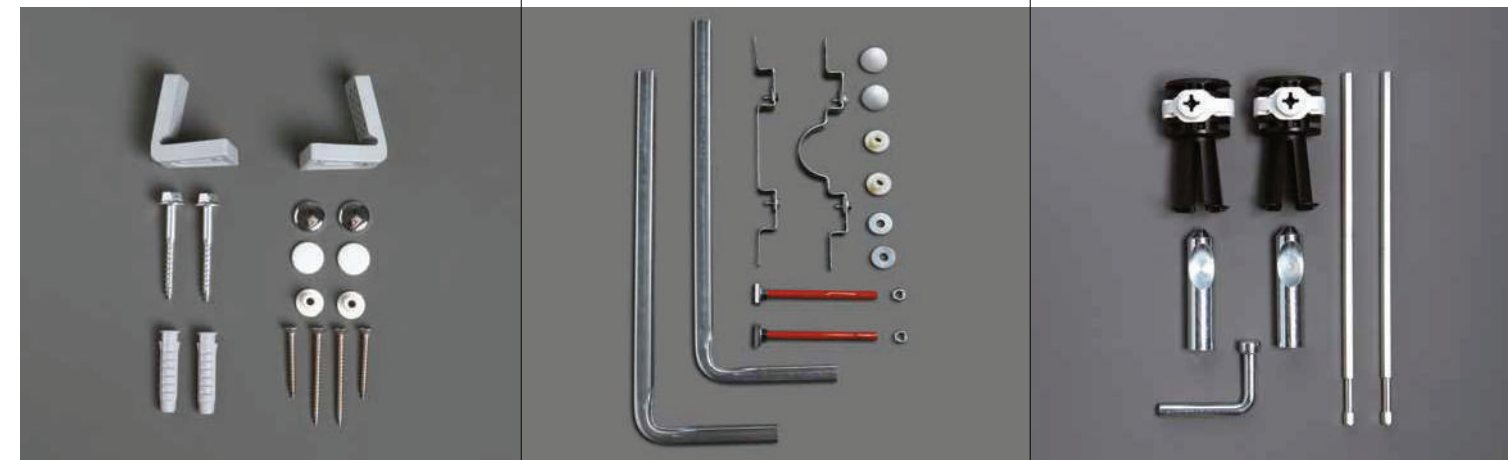

**D 22**

kg 1

Batteria di scarico doppio flusso cromo per cassetta monoblocco LFT 26/EVO 09/EL 09

*Push button double flush mechanism in chrome-finish for close coupled cistern LFT 26/EVO 09/EL 09*

*Mécanisme de chasse, double chasse, avec bouton chromé pour réservoir monobloc LFT 26/EVO 09/EL 09*

*Spuelung, 2-Mengen-Spuelung mit WC-Taste in Chrom für Komplett-Spülkasten LFT 26/EVO 09/EL 09*

*Механизм слива с двойным потоком хромированный для моноблочного бачка LFT 26/EVO 09/EL 09*

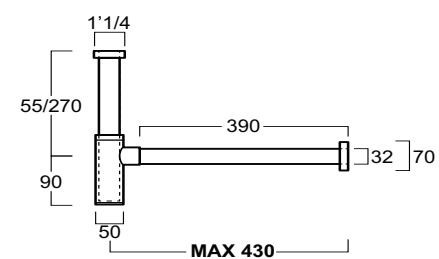
**SIF 165**

kg 1,1

Sifone cilindrico lavabo da 1 1/4"

*Cylindrical trap for washbasin 1 1/4"*

*Siphon cylindrique pour lavabo de 1 1/4"*

*Siphon, zylindrisch für Waschbecken 1 1/4"*

*Сифон цилиндрической формы для раковин*

**SIF 270**

kg 1,4

Sifone cilindrico lavabo da 1 1/4"

*Cylindrical trap for washbasin 1 1/4"*

*Siphon cylindrique pour lavabo de 1 1/4"*

*Siphon, zylindrisch für Waschbecken 1 1/4"*

*Сифон цилиндрической формы для раковин*

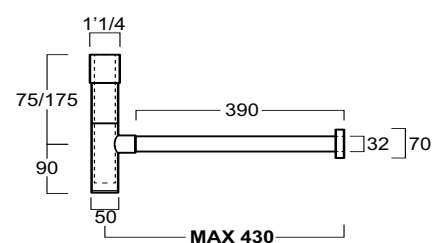
**SIF 125**

kg 1

Sifone cilindrico per bidet da 1 1/4"

*Cylindrical trap for bidet 1 1/4"*

*Siphon cylindrique pour bidet de 1 1/4"*

*Siphon, zylindrisch für Bidet 1 1/4"*

*Цилиндрический сифон для биде 1 1/4"*

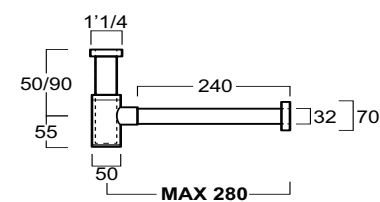
**PLCR**

kg 0,4

Piletta "shut rapid" o "free flow" cromo

*Pop-up waste "shut rapid" or "free flow" chrome*

*Bonde "shut rapid" ou "free flow" chromée*

*Abflusstöpsel "Shut rapid" oder "free flow" chrom*

*Донный клапан типа "быстрый затвор" или "свободный поток" хром*

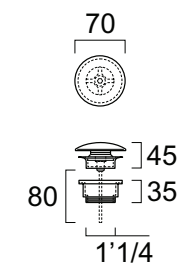
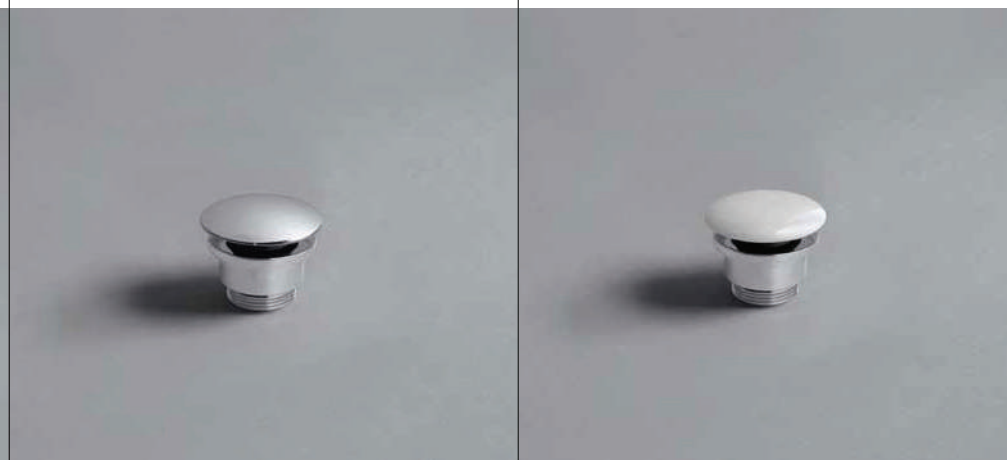
**PLCE**

kg 0,5

Piletta "shut rapid" o "free flow" in ceramica

*Pop-up waste "shut rapid" or "free flow" ceramic*

*Bonde "shut rapid" ou "free flow" céramique*

*Abflusstöpsel "Shut rapid" oder "free flow" keramik*

*Донный клапан типа "быстрый затвор" или "свободный поток" керамика*

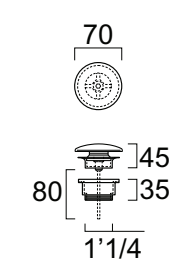
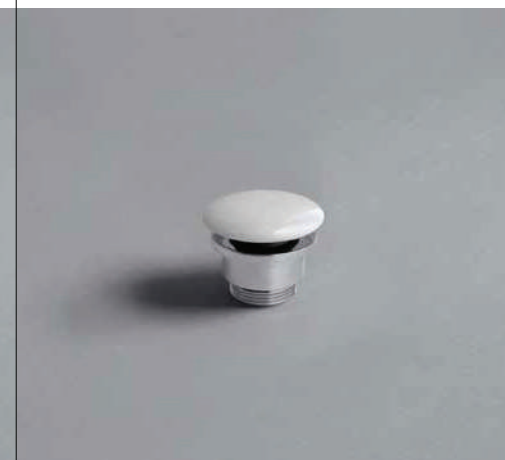

\* Disponibile in tutti i colori

*Available in all colors*

*Disponible dans tous les coloris*

*Verfuegbar in alle die Farben*

*В наличии все цвета.*

# vignoni

DESIGN: UFFICIO TECNICO

Si ispira all'italianità più nobile la collezione Vignoni di Simas, con l'esplicito richiamo alla territorialità vetusta legata all'acqua di Bagno Vignoni. Un design che parte dall'ovale per una linea concepita all'insegna di un taglio contemporaneo con dimensioni poco più grandi della norma. La configurazione morbida spinge verso la complicità di un "abbraccio" e lo spessore va verso la leggerezza e l'estrema ricerca del sottile.

Simas's Vignoni collection is inspired on the noblest "italianity", with an explicit reference to Italian territoriality, linked to the water of Bagno Vignoni. A design that starts with oval shapes, for a line conceived under the light of a contemporary cut, with a size slightly larger than average. The soft configuration pushes towards the complicity of a "hug", and the thickness moves towards the lightness and the extreme research of slinness.

La collection Vignoni de Simas s'inspire du style italien le plus noble, avec un rappel explicite à la vétusté du lieu liée à l'eau de Bagno Vignoni. Un design partant de l'ovale pour une ligne conçue avec une découpe contemporaine et des dimensions légèrement supérieures à la norme. La douce configuration tend vers la complicité d'un « câlin » et l'épaisseur inspire la légèreté et l'extrême recherche de la finesse.

Die besonders edel-italienisch anmutende Kollektion Vignoni von Simas erinnert explizit an die mit Wasser verbundene Ursprünglichkeit von Bagno Vignoni. Ein auf dem Oval aufbauendes Design, aus dem sich eine Produktserie mit zeitgenössischem Schnitt und etwas über der Norm liegenden Abmessungen ergibt. Eine weiche Konfiguration drängt in Richtung einer komplizenhaften "Umarmung", die Dicke vermittelt Leichtigkeit und die Suche nach extrem schmalen, dünnen Elementen.

Коллекция Vignoni от Simas пронизана подлинным итальянским духом, напоминают облик термальных источников Баньо-Виньони. Базовая овальная форма остро современна, все размеры чуть более крупные по сравнению с принятыми. Линии рождают ассоциации с мягкими объятиями, а максимально облегченные объемы придают изделиям изысканную утонченность.



VI 10 60x46x16



VI 11 80x50x16



VI 12 100x52x16



VI 19 37x56x31



VI 18 37x56x31



VI 04 37x56x42



VI 01 37x56x42



CT 09 42x13,5x100,5



VI 24 37x56x50



VI 21 37x56x50

# riconfigurazione geometrica per l'estrema ricerca del sottile.

Geometric reconfiguration for the extreme research of slimness.  
Reconfiguration géométrique pour l'extrême recherche de la finesse.  
Geometrische Neugestaltung für die Suche nach extrem schmalen, dünnen Elementen.  
Пересмотр геометрического образа как поиск предельной утонченности.

**VI 12 >**  
Consolle 100  
Console 100

**< VI 04**  
Bidet carenato  
Back to wall bidet

**< VI 01**  
Vaso carenato "Rimless"  
"Rimless" Back to wall WC

**VI 12**

Consolle 100 da appoggio o sospesa  
 Counter top or wall hung console 100  
 Console 100 d'appui ou suspendue  
 Konsole 100 Aufsatz oder Wandhaengend  
 Консоль 100 подвесная или опорная

**VI 11**

Lavabo 80 da appoggio o sospeso  
 Counter top or wall hung washbasin 80  
 Lavabo 80 d'appui ou suspendu  
 Waschtisch 80 Aufsatz oder Wandhaengend  
 Умывальник 80 подвесной или опорный





**VI 11**

Lavabo 80 da appoggio o sospeso  
 Counter top or wall hung washbasin 80  
 Lavabo 80 d'appui ou suspendu  
 Waschtisch 80 Aufsatz oder Wandhaengend  
 Умывальник 80 подвесной или опорный



.....

**ACCESSORI DI COMPLETAMENTO**  
**ACCESSORIES AVAILABLE**

- VIS 2** Specchio cm 120x40  
 Mirror cm 120x40  
**VIL 1** Lampada a Led per VIS 1/VIS 2  
 Led lamp for VIS 1/VIS 2  
**VIM 1** Top d'appoggio cm 120x46 Rovere Chiaro  
 Wash basin top cm 120x46 Light Oak finish  
**VIM 3** Cassettiera modulare cm 70x46 Bianco Opaco  
 Modular drawer cm 70x46 Matte White finish



**VI 10**

Lavabo 60 da appoggio o sospeso  
 Counter top or wall hung washbasin 60  
 Lavabo 60 d'appui ou suspendu  
 Waschtisch 60 Aufsatz oder Wandhaengend  
 Умывальник 60 подвесной или опорный

.....  
**ACCESSORI DI COMPLETAMENTO**  
**ACCESSORIES AVAILABLE**

**VIS 2** Specchio cm 140x40  
 Mirror cm 140x40  
**VIL 1** Lampada a Led per VIS 1/VIS 2  
 Led lamp for VIS 1/VIS 2  
**VIM 2** Top d'appoggio cm 140x46 Rovere Chiaro  
 Wash basin top cm 140x46 Light Oak finish  
**VIM 3** Cassettiera modulare cm 70x46 Antracite Opaco  
 Modular drawer cm 70x46 Matte Anthracite finish  
**VIP 1** Porta asciugamani laterale per VIM 1/VIM 2  
 Chrome plated brass side towel for VIM 1/VIM 2



**VI 18**

Vaso sospeso "Rimless". Completo di set di fissaggio F 85  
 "Rimless" wall hung WC. Complete with fixing set F 85  
 Cuvette suspendue "Rimless". Complet de set de fixation F 85  
 "Rimless" Hänge-WC. Inklusive Befestigungsset F 85  
 Унитаз подвесной "Rimless" вместе с крепежным комплектом F 85

**VI 19**

Bidet sospeso monoforo. Completo di set di fissaggio F 85  
 Wall hung bidet with single tap hole. Complete with fixing set F 85  
 Bidet suspendu mono trou. Complet de set de fixation F 85  
 Hänge-Bidet, Einloch. Inklusive Befestigungsset F 85  
 Биде подвесное с одним отверстием. Комплектуется набором крепежей F 85



**ACCESSORI DI COMPLETAMENTO**  
**ACCESSORIES AVAILABLE**

**VI 003** Coprivaso in termoindurente  
 con cerniere cromo  
 Thermoset toilet seat with chrome-finish hinges

**VI 004** Coprivaso in termoindurente  
 con cerniere rallentate cromo  
 Thermoset toilet seat  
 with chrome-finish soft-closing hinges



**VI 04**

Bidet monoforo carenato  
*Back to wall bidet with single tap hole*  
 Bidet mono trou caréné  
*Bidet, Einloch, verkleidet*  
 Биде приставное с одним отверстием

**VI 01**

Vaso carenato "Rimless" con scarico parete o pavimento  
*"Rimless" Back to wall WC with wall or floor outlet*  
 Cuvette carénée "Rimless" décharge au mur ou au sol  
*"Rimless" WC, verkleidet. Wand- oder Bodenanschluss*  
 Унитаз приставной "Rimless". Горизонтальный или вертикальный слив

**ACCESSORI DI COMPLETAMENTO**  
**ACCESSORIES AVAILABLE**

**VI 003** Coprivaso in termoindurente con cerniere cromo  
*Thermoset toilet seat with chrome-finish hinges*

**VI 004** Coprivaso in termoindurente con cerniere rallentate cromo  
*Thermoset toilet seat with chrome-finish soft-closing hinges*

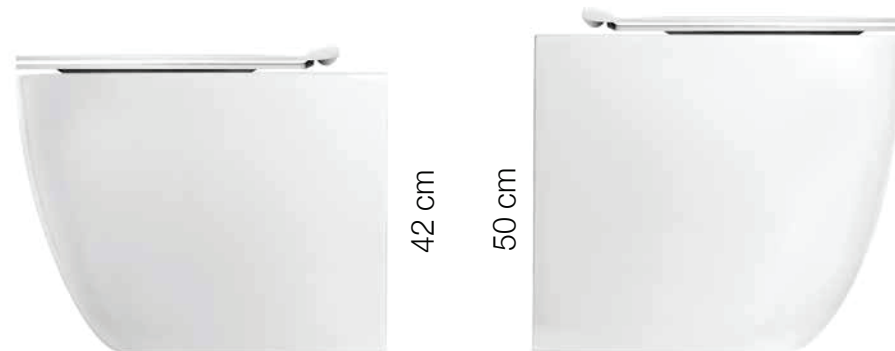
**VI 21**

Vaso carenato H 50 "Rimless". Scarico parete o pavimento  
*"Rimless" back to wall WC H 50 cm. Wall or floor outlet*  
 Cuvette carénée H 50 "Rimless". Décharge au mur ou au sol  
*"Rimless" WC H 50, verkleidet. Wand- oder Bodenanschluss*  
 Унитаз обтекаемой формы H 50 "Rimless". Слив на стене или полу

**VI 24**

Bidet H 50 monoforo carenato  
*Back to wall bidet cm H 50 with single tap hole*  
 Bidet mono trou caréné H 50  
*Bidet, Einloch, verkleidet H 50*  
 Биде с одним отверстием, обтекаемой формы H 50

**ACCESSORI DI COMPLETAMENTO**  
**ACCESSORIES AVAILABLE**

**VI 003** Coprivaso in termoindurente con cerniere cromo  
*Thermoset toilet seat with chrome-finish hinges*

**VI 004** Coprivaso in termoindurente con cerniere rallentate cromo  
*Thermoset toilet seat with chrome-finish soft-closing hinges*



### VI 01

Vaso carenato "Rimless" con scarico parete o pavimento  
 "Rimless" Back to wall WC with wall or floor outlet  
 Cuvette carénée "Rimless" décharge au mur ou au sol  
 "Rimless" WC, verkleidet. Wand- oder Bodenanschluss  
 Унитаз приставной "Rimless". Горизонтальный или вертикальный слив

### CT 09 / D20

Cassetta monoblocco con batteria di scarico e apposito set di fissaggio  
 Close coupled cistern with flush mechanism and special fixing set  
 Caisse mono bloc avec batterie de décharge et spécial kit de fixation  
 Monoblock-Spülkasten mit Abflussmechanik und Befestigungsset  
 Бачок моноблок с механизмом слива и специальным набором крепежей

#### ACCESSORI DI COMPLEMENTO ACCESSORIES AVAILABLE

**VI 003** Coprivaso in termoindurente  
 con cerniere cromo  
 Thermoset toilet seat  
 with chrome-finish hinges

**VI 004** Coprivaso in termoindurente  
 con cerniere rallentate cromo  
 Thermoset toilet seat  
 with chrome-finish soft-closing hinges



**VI 10**

kg 15

Lavabo 60 da appoggio o sospeso monoforo

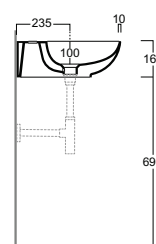
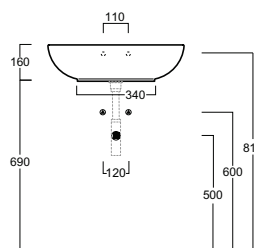
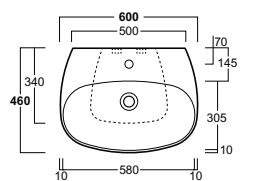
*Counter top or wall hung washbasin 60 for single tap hole**Lavabo 60 d'appui ou suspendu mono trou**Waschbecken 60, Aufsatz oder wandhängend, für Einlocharmatur**Раковина 60 накладная или подвесная с одним отверстием***VI 11**

kg 18

Lavabo 80 da appoggio o sospeso monoforo

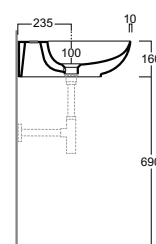
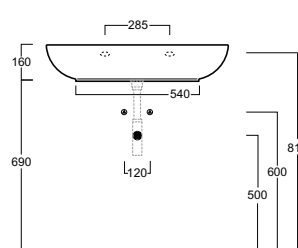
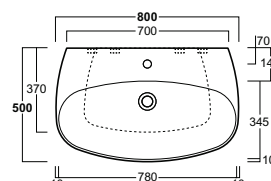
*Counter top or wall hung washbasin 80 for single tap hole**Lavabo 80 d'appui ou suspendu mono trou**Waschbecken 80, Aufsatz oder wandhängend, für Einlocharmatur**Раковина 80 накладная или подвесная с одним отверстием***VI 12**

kg 22

Consolle 100 da appoggio o sospesa monoforo

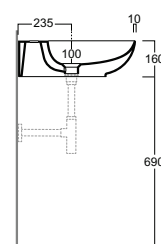
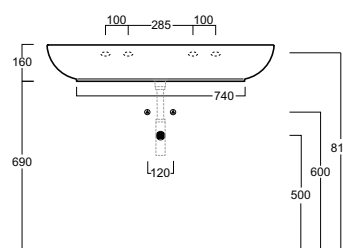
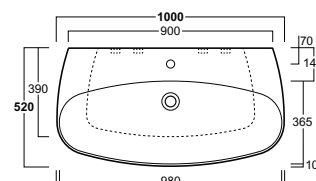
*Counter top or wall hung console 100 for single tap hole**Consolle 100 d'appui ou suspendue mono trou**Konsole 100, Aufsatz oder, für Einlocharmatur**Консоль 100 накладная или подвесная с одним отверстием***VI 04**

kg 23,5

Bidet monoforo carenato

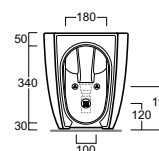
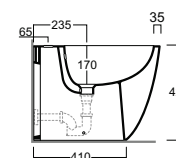
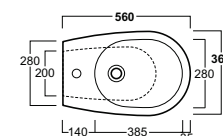
*Back to wall bidet with single tap hole**Bidet mono trou caréné**Bidet, Einloch, verkleidet**Биде с одним отверстием, обтекаемой формы***VI 01**

kg 25

Vaso carenato "Rimless". Scarico parete o pavimento

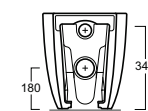
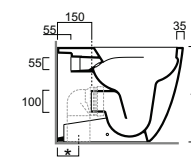
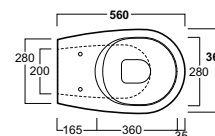
*"Rimless" Back to wall WC. Wall or floor outlet**Cuvette carénée "Rimless". Décharge au mur ou au sol**"Rimless" WC, verkleidet. Wand-oder Bodenanschluss**Унитаз обтекаемой формы "Rimless". Слив на стене или полу***VI 19 / F 85**

kg 19

Bidet monoforo sospeso. Completo di set di fissaggio F 85

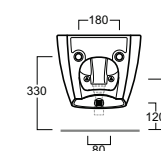
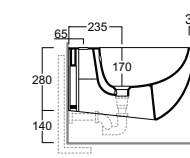
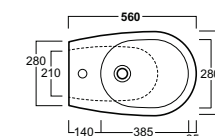
*Wall hung bidet with single tap hole. Complete with fixing set F 85**Bidet mono trou suspendu. Complet de set de fixation F 85**Hänge-Bidet, Einloch. Inklusive Befestigungsset F 85**Биде с одним отверстием, подвесное, вместе с крепежным комплектом F 85*

**VI 18 / F 85**

kg 20

Vaso sospeso "Rimless". Completo di set di fissaggio F 85

"Rimless" Wall hung WC. Complete with fixing set F 85

Cuvette suspendue "Rimless". Complet de set de fixation F 85

"Rimless" Hänge-WC. Inklusive Befestigungsset F 85

Унитаз подвесной вместе "Rimless" с крепежным комплектом F 85

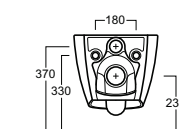
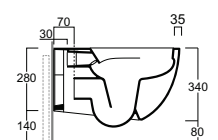
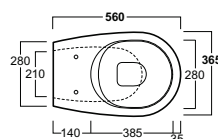
**VI 24**

kg 24,5

Bidet H 50 monoforo carenato

Back to wall bidet cm H 50 with single tap hole

Bidet mono trou caréné H 50

Bidet, Einloch, verkleidet H 50

Биде с одним отверстием, обтекаемой формы H 50

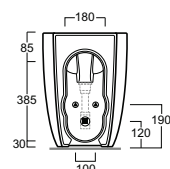
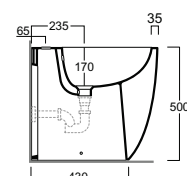
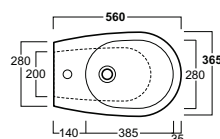
**VI 21**

kg 26

Vaso carenato H 50 "Rimless". Scarico parete o pavimento

"Rimless" Back to wall WC H 50 cm. Wall or floor outlet

Cuvette carénée H 50 "Rimless". Décharge au mur ou au sol

"Rimless" WC H 50, verkleidet. Wand-oder Bodenanschluss

Унитаз обтекаемой формы H 50 "Rimless". Слив на стене или полу

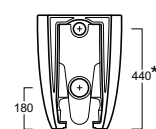
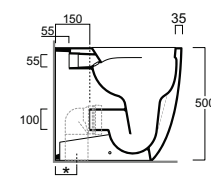
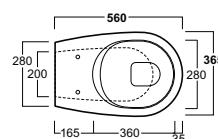
**CT 09 / D 20**

kg 23

Cassetta monoblocco con batteria di scarico. Per vaso EL 01 / LFT 20 / VI 01 / BB 01 / FL 61

Close coupled cistern with flush mechanism. For WC EL 01 / LFT 20 / VI 01 / BB 01 / FL 61

Caisse mono bloc avec batterie de décharge. Pour cuvette EL 01 / LFT 20 / VI 01 / BB 01 / FL 61

Monoblock-Spülkasten mit Abflussmechanik. Für WC EL 01 / LFT 20 / VI 01 / BB 01 / FL 61

Бачок моноблок с механизмом слива и специальным набором крепежей. Для унитазов EL 01 / LFT 20 / VI 01 / BB 01 / FL 61

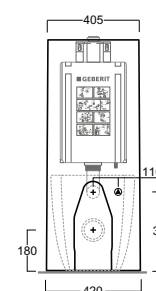
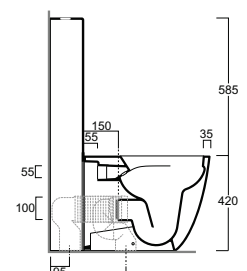
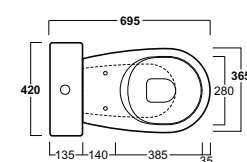
**VI 003**

kg 3

Coprivaso in termoindurente cerniere cromo a sgancio rapido

Thermoset toilet seat with chrome-finish hinges quick-release

Abattant en thermo durcisseur charnières chromées declipsables

WC Deckel, thermoverformt, Chromscharniere "quick-release"

Сиденье быстросъемное из терморезины с петлями хром

**VI 004**

kg 3

Coprivaso in termoindurente con cerniere rallentate cromo a sgancio rapido

Wrap-around thermoset toilet seat with chrome-finish soft-closing hinges quick-release

Abattant enveloppant en thermo durcisseur avec charnières ralenties chromées declipsables

WC Deckel, thermoverformt, Chromscharniere mit Absenkautomatik quick-release

Сиденье с микролифтом быстросъемное из терморезины с петлями хром

## RIMLESS SYSTEM

RIMLESS System  
RIMLESS système  
RIMLESS System  
Система RIMLESS



RISPARMIO IDRICO  
WATER SAVING



PULIZIA FACILE E VELOCE  
EASY AND FAST CLEANING

Tutti i vasi Vignoni sono rimless, ossia senza brida, cioè senza il bordo attraverso cui passa il risciacquo d'acqua che rappresenta circa il 20% del bacino interno del sanitario ed è generalmente di difficile pulizia. Il nuovo sistema di scarico determina un design molto più lineare e consente una pulizia più facile, efficace e senza schizzi, a garanzia di una migliore igiene. Con un effetto estetico sicuramente superiore.

All Vignoni toilets are rimless, i.e. without the edge through which the water passes, an edge that represents approximately 20% of the inner basin of the toilet, and is usually difficult to clean. The new flushing system results in a much more linear design that is easier to clean. Flushing is more effective, with less spray, for superior hygiene. And with a decidedly superior aesthetic effect.

Toutes les toilettes Vignoni sont sans rabat, c'est-à-dire sans la partie à travers laquelle passe l'eau de rinçage représentant environ 20% de la cuvette interne, généralement difficile à nettoyer. Le nouveau système de chasse d'eau produit un design bien plus linéaire et permet un nettoyage plus facile, efficace et sans éclaboussures, en garantie d'une meilleure hygiène. Avec un effet esthétique nettement supérieur.

Alle Vignoni WCs sind "rimless", d.h. ohne den Rand, durch den das Spülwasser verläuft, und der ca. 20% des Innenbeckens eines WCs ausmacht und meist relativ schwierig zu reinigen ist. Das neue Spülsystem hingegen ermöglicht ein deutlich lineares, reinigungsfreundlicheres Design, das effizient, spritzfrei und somit Garantie für mehr Hygiene ist. Und auch die Optik wird dadurch aufgewertet.

У унитазов Vignoni нет бортиков, за которыми скрываются отверстия для смывной воды и которые порой составляют до 20% объема чаши. Из-за бортиков унитаза бывает трудно поддерживать в чистоте, а при новой системе ополаскивания не образуется брызг, гигиенический уход за унитазом становится простым и эффективным, а сама чаша приобретает простую и лаконичную форму, выигрывая в эстетичности.

## SYSTEM RENOVATE

RENOVATE System  
RENOVATE système  
RENOVATE System  
Система RENOVATE

VI 01

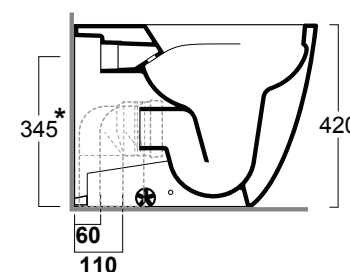

VI 21

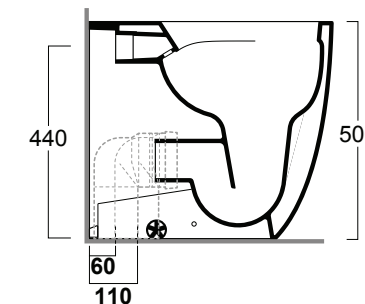

CT01 ⊕

Curva tecnica per lo scarico a pavimento regolabile da 6 a 11 cm

Curved pipe for floor outlet, adjustable from 6 to 11 cm

Courbe technique pour l'évacuation au sol, réglable de 6 à 11 cm

Wand-oder Bogenrohr zu Stand WC mit Abstand 6 – 11 cm

Техническое колено для вертикального слива, регулируемое от 6 до 11 см

VI 01

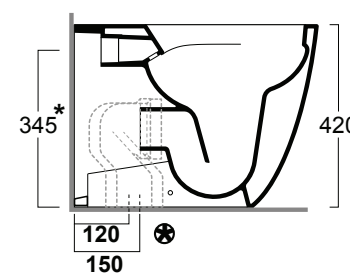

VI 21

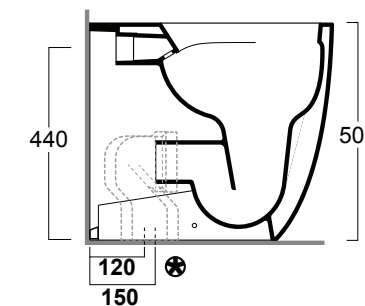

CT02 ⊕

Curva tecnica per lo scarico a pavimento regolabile da 12 a 15 cm

Curved pipe for floor outlet, adjustable from 12 to 15 cm

Courbe technique pour l'évacuation au sol, réglable de 12 à 15 cm

Wand-oder Bogenrohr zu Stand WC mit Abstand 12 – 15 cm

Техническое колено для вертикального слива, регулируемое от 12 до 15 см

VI 01

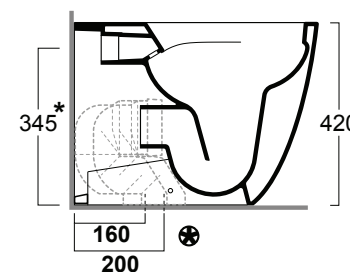

VI 21

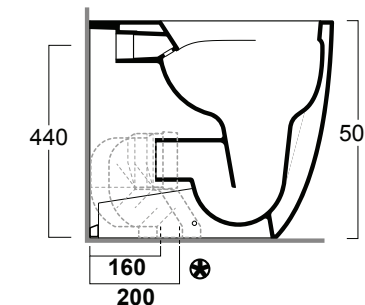

CT03 ⊕

Curva tecnica per lo scarico a pavimento regolabile da 16 a 20 cm

Curved pipe for floor outlet, adjustable from 16 to 20 cm

Courbe technique pour l'évacuation au sol, réglable de 16 à 20 cm

Wand-oder Bogenrohr zu Stand WC mit Abstand 16 – 20 cm

Техническое колено для вертикального слива, регулируемое от 16 до 20 см

\*

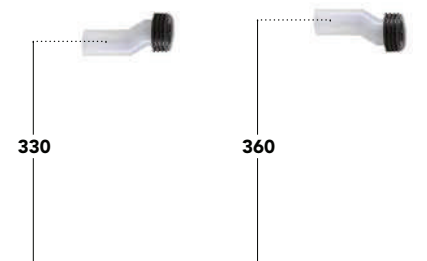

CT04 \*

Raccordo eccentrico per ingresso acqua: h 33 cm o h 36 cm

Eccentric pipe for water inlet 33 cm or 36 cm

Raccord excentrique pour l'entrée de l'eau h 33 cm ou h 36 cm

Exenterstützen für Wasserzulauf Höhe 33 oder 36 cm

Экцентрический переход для входа воды: h 33 см или h 36 см



**VIM 1**

kg 12,5

Top d'appoggio 120x46 (kit di montaggio incluso).

*Wash basin top 120x46 (fixing kit included).**Plain pour lavabo 120x46 (kit de fixation inclus).**Waschtischplatte 120x46 (inklusive Befestigungsset).**Столешница под раковину 120x46 (набор крепежей включен)***VIM 3**

kg 21

Cassetiera modulare 70x46 (kit di montaggio incluso).

*Modular drawer 70x46 (fixing kit included).**Tiroir modulaire 70x46 (kit de fixation inclus).**Kommode modular 70x46 (inklusive Befestigungsset).**Модульный ящик 70x46 (набор крепежей включен)***VIS 1**

kg 7,5

Specchio 120x40.

*Mirror 120x40.**Miroir 120x40.**Spiegel 120x40.**Зеркало 120x40.***VIP 1**

kg 0,3

Porta asciugamani laterale in ottone cromato per VIM 1 / VIM 2.

*Chrome plated brass side towel holder for VIM 1 / VIM 2.**Porte serviette latéral chromé pour VIM1 / VIM2.**Chromiert Seitenhandtuchhalter für VIM1/ VIM2.**Полотенцедержатель боковой, хромированная латунь, для VIM 1/VIM 2.***VIL 1**

kg 0,5

Lampada a led per VIS 1 / VIS 2.

*Led lamp for VIS 1 / VIS 2.**Lampe à LED pour VIS1/VIS2.**LED Lampe für VIS1/VIS2.**Лампа led для VIS 1/VIS 2.***PH 100**

kg 0,2

Piletta universale in ABS per piano/lavabo.

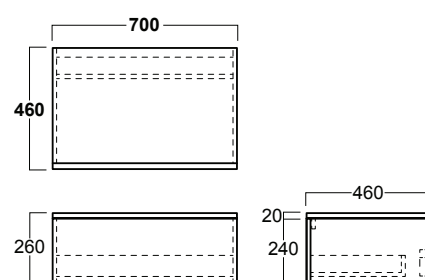
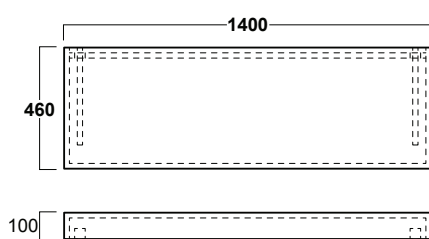
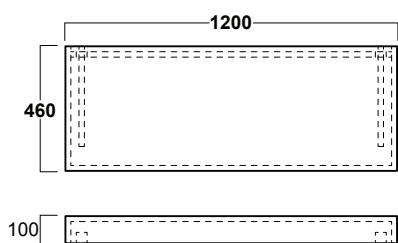
*ABS universal wash basin top drain.**Bonde universelle en ABS pour plain de lavabo.**ABS Universalablaufgarnitur für Waschtischplatte.**Универсальный донный клапан из ABS для раковины.*

 Bianco Opaco  
Matte White  
Blanc Mat  
Matt weiß  
белый матовый

 Antracite Opaco  
Matte Anthracite  
Anthracite mat  
Anthraxit matt  
матовый антрацит

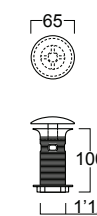
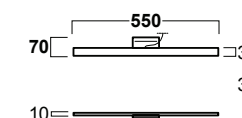
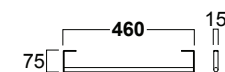
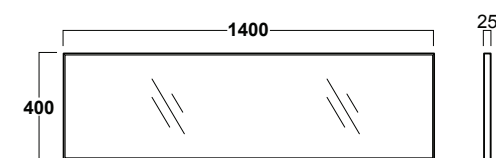
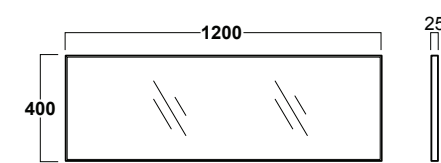
**VIM 2**

kg 14,5

Top d'appoggio 140x46 (kit di montaggio incluso).

*Wash basin top 140x46 (fixing kit included).**Plain pour lavabo 140x46 (kit de fixation inclus).**Waschtischplatte 140x46 (inklusive Befestigungsset).**Столешница под раковину 140x46 (набор крепежей включен)***VIS 2**

kg 8

Specchio 140x40.

*Mirror 140x40.**Miroir 140x40.**Spiegel 140x40.**Зеркало 140x40.*

**F 89**

kg 0,18

Set viti di fissaggio per lavabo

*Set fixing screws for washbasin**Set de vis de fixation pour lavabo**Montageset Waschbecken**Комплект крепежных винтов для раковины***F 88**

kg 0,12

Set viti di fissaggio laterali cromo/bianco per vaso o bidet

*Set of chrome/white lateral fixing screws for wc or bidet**Set de vis de fixation latérales chromées/blanc pour WC ou bidet**Montageset seitliche Montage weiss/chrom für WC oder Bidet**Комплект боковых крепежных винтов хром/белый для унитаза или биде***F 84**

kg 3

Coppia staffe di fissaggio per vaso o bidet sospesi

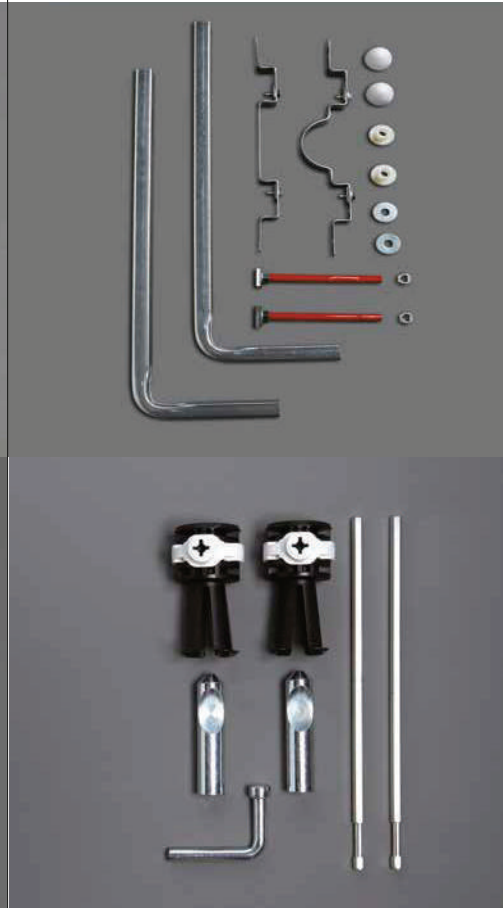
*A pair of brackets for wall hung wc or bidet**Paire d'équerres de fixation pour cuvette ou bidet suspendus**Paar Befestigungshalterungen für Wandklosett oder Wandbidets**Пара крепежных скоб для подвесных унитаза или биде***F 85**

kg 0,3

Set viti fissaggio a completamento staffe F 84 per vaso o bidet sospesi

*Fixing Kit for F 84 brackets for wall hung WC or bidet**Jeu de vis de fixation pour équerre F 84 pour cuvette ou bidet suspendu**Satz Befestigungsschrauben zur Ergänzung der Halterungen F 84 Wandklosett oder Wandbidet**Комплект крепежных винтов для комплектования скоб F 84 для подвесного унитаза или биде***SIF 165**

kg 1,1

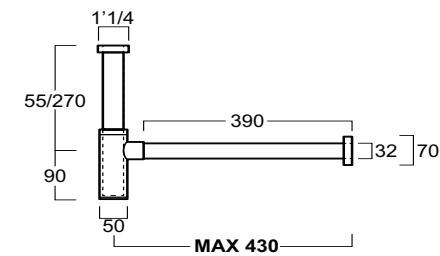
Sifone cilindrico lavabo da 1<sup>1/4</sup>"*Cylindrical trap for washbasin 1<sup>1/4</sup>"**Siphon cylindrique pour lavabo de 1<sup>1/4</sup>"**Siphon, zylindrisch für Waschbecken 1<sup>1/4</sup>"**Сифон цилиндрической формы для раковин***SIF 270**

kg 1,4

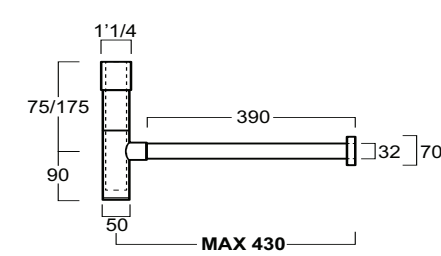
Sifone cilindrico lavabo da 1<sup>1/4</sup>"*Cylindrical trap for washbasin 1<sup>1/4</sup>"**Siphon cylindrique pour lavabo de 1<sup>1/4</sup>"**Siphon, zylindrisch für Waschbecken 1<sup>1/4</sup>"**Сифон цилиндрической формы для раковин***SIF 125**

kg 1

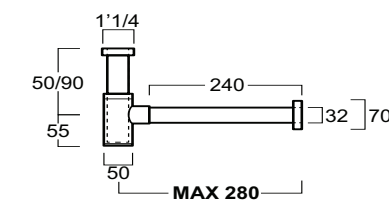
Sifone cilindrico per bidet da 1<sup>1/4</sup>"*Cylindrical trap for bidet 1<sup>1/4</sup>"**Siphon cylindrique pour bidet de 1<sup>1/4</sup>"**Siphon, zylindrisch für Bidet 1<sup>1/4</sup>"**Цилиндрический сифон для биде 1<sup>1/4</sup>"***PLCR**

kg 0,4

Piletta "shut rapid" o "free flow" cromo

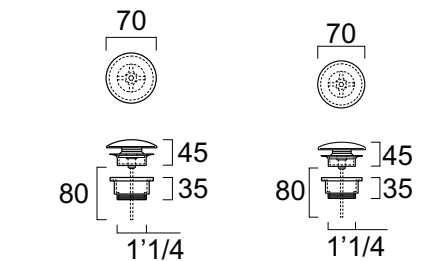
*Pop-up waste "shut rapid" or "free flow" chrome**Bonde "shut rapid" ou "free flow" chromée**Abflusstöpsel "Shut rapid" oder "free flow" chrom**онный клапан типа "быстрый затвор" или "свободный поток" хром***PLCE**

kg 0,5

Piletta "shut rapid" o "free flow" in ceramica\*

*Pop-up waste "shut rapid" or "free flow" ceramic**Bonde "shut rapid" ou "free flow" céramique**Abflusstöpsel "Shut rapid" oder "free flow" keramik**Донный клапан типа "быстрый затвор" или "свободный поток" керамика*

\* Disponibile in tutti i colori  
 Available in all colors  
 Disponible dans tous les coloris  
 Verfüegbar in alle die Farben  
 В наличии все цвета

# baden baden

DESIGN: UFFICIO TECNICO

Dalla più classica cultura termale prende vita la collezione Baden-Baden, che dell'epoca rievoca lo stile ora rinnovato nelle linee rigorose, che si attenuano nella morbida rotondità dei bordi. Una collezione che sorprende per lo stile essenziale, dove il 'nuovo classico' emerge prestante in questi pezzi dalla struttura architettonica decisa, che raccontano nel design, nei materiali, nei nuovi colori la storia e la bellezza del suo essere totalmente italiana.

The collection Baden-Baden takes birth from the most classical thermal culture; it recalls the style of that age and though renews it with rigorous shapes softened by round edges.

A collection that surprises for its essential style, where the 'new classic' proudly emerges from these pieces with a strong architectural structure and where the design, the materials, the new colours represent the history and the beauty of its being totally Italian.

La collection Baden Baden s'inspire de la culture thermale la plus classique, qui rappelle le style de cette période (mis au gout du jour) pour ses lignes rigoureuses qui s'estompent dans la douceur des bords. Une surprenante collection pour son style essentiel où « le classique nouveau » apparait dans toute sa splendeur dans ces pièces caractérisées par une structure architecturale bien définie. Ces œuvres, grâce à leur design, leurs matériaux, leurs nouvelles couleurs, sont un exemple de l'histoire et de la beauté totalement Italienne.

Aus der klassischen Thermalkultur entsteht die Kollektion Baden-Baden, die an den Stil dieser Epoche erinnert, der nun mit strengen Linien, die sich in der weichen Rundung der Ränder verlieren, erneuert wird. Eine Kollektion, die durch den essentiellen Stil überrascht, wo der "neue Klassiker in diesen Stücken mit entschiedener architektonischer Struktur anmutig auftaucht, die im Design, den Materialien, den neuen Farben von der Geschichte und Anmut ihres italienischen Wesens erzählen.

От классической культуры римских терм берет свое начало коллекция Baden-Baden, напоминающая о той эпохе своим обновленным стилем со строгими линиями, которые смягчаются мягкой округлостью бортиков.

Коллекция, радующая своим стилем, в котором "новая классика" раскрывается через четкие архитектурные линии, передающие через дизайн, материал и цвет, историю и красоту чисто итальянского происхождения.



BB 11 60x38x14



BB 13 40x45x55



BB 10 60x45x16,5



BB 12 80x45x16,5



BB 01 56x36x42



BB 04 56x36x42



BB 18 56x36x31



BB 19 56x36x31



CT 09 42x13,5x100,5

**> DES2**

Specchio sagomato 75  
Shaped mirror 75

**DE 15**

Mensola 40  
Shelf 40

**< BB 10**

Lavabo 60  
Washbasin 60

**BB 01>**

Vaso carenato "Rimless"  
"Rimless" Back to wall WC

**< BB 04**

Bidet carenato  
Back to wall bidet

**< DE 16**

Mensola 60  
Shelf 60

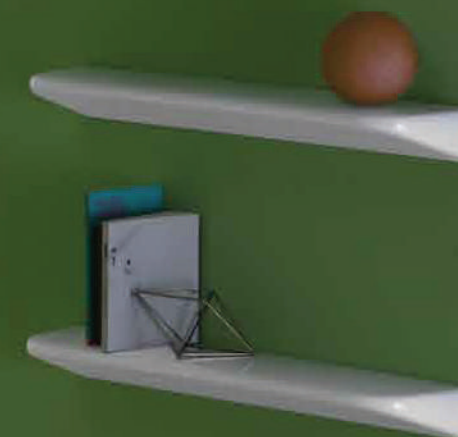

# forme contemporanee di ispirazione classica

Contemporary shapes with a classic soul  
Des formes contemporaines d'inspiration classique  
Zeitgenössische Formen mit klassischer Inspiration  
Современные формы, вдохновленные классикой

**BB 12**

Consolle 80 da appoggio o sospesa  
 Counter top or wall hung console 80  
 Console 80 d'appui ou suspendue  
 Konsole 80 Aufsatz oder Wandhaengend  
 Консоль 80 подвесная или опорная

**BB 10**

Lavabo 60 da appoggio o sospeso  
 Counter top or wall hung washbasin 60  
 Lavabo 60 d'appui ou suspendu  
 Waschtisch 60 Aufsatz oder Wandhaengend  
 Умывальник 60 подвесной или опорный

**DE 15**

Mensola 40 sospesa  
 Wall hung shelf 40  
 Étagère 40 suspendue  
 Hängende 40-er Konsole  
 Полка 40 подвесная



**ACCESSORI DI COMPLETAMENTO**  
**ACCESSORIES AVAILABLE**

**DE 16** Mensola 60 sospesa  
 Wall hung shelf 60  
**DE 15** Mensola 40 sospesa  
 Wall hung shelf 40  
**DES1** Specchio sagomato 60  
 Shaped Mirror 60  
**DES2** Specchio sagomato 75  
 Shaped Mirror 75

**BB 11**

Lavabo 60 da appoggio e incasso  
 Washbasin 60 counter top and inset  
 Lavabo 60 d'appui et à encastrer  
 Waschbecken 60 aufsatz und einbau  
 Раковина 60 накладная и встраиваемая

**DE 16**

Mensola 60 sospesa  
 Wall hung shelf 60  
 Etagère 60 suspendue  
 Hängende 60-er Konsole  
 Полка 60 подвесная



**ACCESSORI DI COMPLETAMENTO**  
**ACCESSORIES AVAILABLE**

**DE 16** Mensola 60 sospesa  
 Wall hung shelf 60

**DE 15** Mensola 40 sospesa  
 Wall hung shelf 40

**DES1** Specchio sagomato 60  
 Shaped Mirror 60

**DES2** Specchio sagomato 75  
 Shaped Mirror 75





ACCESSORI DI COMPLETAMENTO  
ACCESSORIES AVAILABLE

- DE 16 Mensola 60 sospesa  
*Wall hung shelf 60*
- DE 15 Mensola 40 sospesa  
*Wall hung shelf 40*
- DES1 Specchio sagomato 60  
*Shaped Mirror 60*
- DES2 Specchio sagomato 75  
*Shaped Mirror 75*



**BB 13**

- Lavabo 40 H55 sospeso
- Wall hung washbasin 40 H55*
- Lavabo 40 H55 suspendu
- Wandhaengendwaschbecken 40 H55*
- Раковина 40 h55 подвесная

**BB 04**

Bidet monoforo carenato  
*Back to wall bidet with single tap hole*  
 Bidet mono trou caréné  
 Bidet, Einloch, verkleidet  
 Биде с одним отверстием, обтекаемой формы

**BB 01**

Vaso carenato "Rimless". Scarico parete o pavimento  
*"Rimless" back to wall WC. Wall or floor outlet*  
 Cuvette carénée "Rimless". Décharge au mur ou au sol  
 "Rimless" WC, verkleidet. Wand-oder Bodenanschluss  
 Унитаз обтекаемой формы "Rimless". Слив на стене или полу



**ACCESSORI DI COMPLETAMENTO**  
**ACCESSORIES AVAILABLE**

**BB 003** Coprivaso in termoindurente cerniere cromo  
*Thermoset toilet seat with chrome-finish hinges*

**BB 004** Coprivaso in termoindurente con cerniere rallentate cromo  
*Thermoset toilet seat with chrome-finish soft-closing hinges*

**BB 18**

Vaso sospeso "Rimless". Completo di set di fissaggio F 87  
*"Rimless" wall hung WC. Complete with fixing set F 87*  
 Cuvette suspendue "Rimless". Complet de set de fixation F 87  
 "Rimless" Hänge-WC. Inklusive Befestigungsset F 87  
 Унитаз подвесной "Rimless" вместе с крепежным комплектом F 87

**BB 19**

Bidet sospeso monoforo. Completo di set di fissaggio F 87  
*Wall hung bidet with single tap hole. Complete with fixing set F 87*  
 Bidet suspendu mono trou. Complet de set de fixation F 87  
 Hänge-Bidet, Einloch. Inklusive Befestigungsset F 87  
 Биде подвесное с одним отверстием. Комплектуется набором крепежей F 87



**ACCESSORI DI COMPLETAMENTO**  
**ACCESSORIES AVAILABLE**

**BB 003** Coprivaso in termoindurente cerniere cromo  
*Thermoset toilet seat with chrome-finish hinges*

**BB 004** Coprivaso in termoindurente con cerniere rallentate cromo  
*Thermoset toilet seat with chrome-finish soft-closing hinges*





**BB 01**

Vaso carenato "Rimless". Scarico parete o pavimento  
*"Rimless" back to wall WC. Wall or floor outlet*  
 Cuvette carénée "Rimless". Décharge au mur ou au sol  
*"Rimless" WC, verkleidet. Wand-oder Bodenanschluss*  
 Унитаз обтекаемой формы "Rimless". Слив на стене или полу

**CT 09 / D20**

Cassetta monoblocco con batteria di scarico e apposito set di fissaggio  
*Close coupled cistern with flush mechanism and special fixing set*  
 Caisse mono bloc avec batterie de décharge et spécial kit de fixation  
 Monoblock-Spülkasten mit Abflussmechanik und Befestigungsset  
 Бачок моноблок с механизмом слива и специальным набором крепежей



.....

**ACCESSORI DI COMPLETAMENTO**  
**ACCESSORIES AVAILABLE**

**BB 003** Coprivaso in termoindurente cerniere cromo  
*Thermoset toilet seat with chrome-finish hinges*

**BB 004** Coprivaso in termoindurente con cerniere rallentate cromo  
*Thermoset toilet seat with chrome-finish soft-closing hinges*



**DE 15**

Mensola 40 sospesa (fissaggi inclusi)  
 Wall hung shelf 40 (fixing screws included)  
 Étagère 40 suspendue (fixations incluses)  
 Hängende 40-er Konsole (inklusive Befestigungsset)  
 Полка 40 подвесная. крепления включены

**DE 15**

Mensola 40 sospesa  
 Wall hung shelf 40

**DE 16**

Mensola 60 sospesa  
 Wall hung shelf 60

**DES1**

Specchio sagomato 60  
 Shaped mirror 60

**DES2**

Specchio sagomato 75  
 Shaped mirror 75

**BB 12**

kg 16

Consolle 80 da appoggio o sospesa monoforo

*Counter top or wall hung console 80 for single tap hole**Console 80 d'appui ou suspendue monotrou**Konsole 80 Aufsatz oder Wandhaengend für Einlocharmatur**Консоль 80 подвесная или опорная с одним отверстием***BB 10**

kg 15

Lavabo 60 da appoggio o sospeso monoforo

*Counter top or wall hung washbasin 60 for single tap hole**Lavabo 60 d'appui ou suspendu monotrou**Waschtisch 60 Aufsatz oder Wandhaengend für Einlocharmatur**Умывальник 60 подвесной или опорный с одним отверстием***BB 13/F 87**

kg 22

Lavabo 40 H55 sospeso. Completo di set di fissaggio F 87

*Wall hung washbasin 40 H55. Complete with fixing set F 87.**Lavabo 40 H55 suspendu. Complet de set de fixation F 87.**Wandhaengendwaschbecken 40 H55. Inklusive Befestigungsset F 87.**Раковина 40 h55 подвесная. Комплектуется набором крепежей F 87.***BB 11**

kg 13

Lavabo 60 da appoggio e incasso

*Counter top and fully inset washbasin 60**Lavabo 60 d'appui**Aufsatzwaschbecken 60**Раковина 60 накладная***DE 15**

kg 5

Mensola 40 sospesa (fissaggi inclusi)

*Wall hung shelf 40 (fixing screws included)**Etagère 40 suspendue (fixations incluses)**Hängende 40-er Konsole (inklusive Befestigungsset)**Полка 40 подвесная. крепления включены***DE 16**

kg 3

Mensola 60 sospesa (fissaggi inclusi)

*Wall hung shelf 60 (fixing screws included)**Etagère 60 suspendue (fixations incluses)**Hängende 60-er Konsole (inklusive Befestigungsset)**Полка 60 подвесная. крепления включены***BB 04/ F91**

kg 18

Bidet monoforo carenato. Completo di set di fissaggio F 91

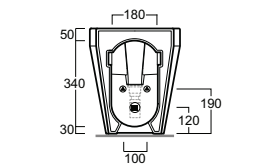
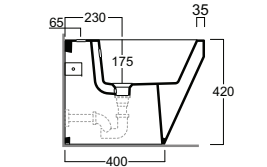
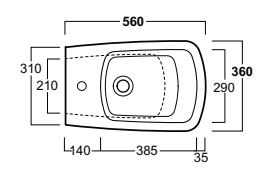
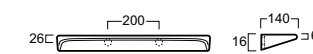
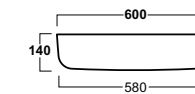
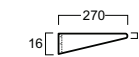
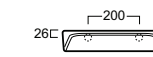
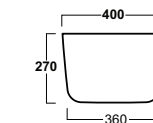
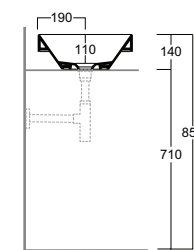
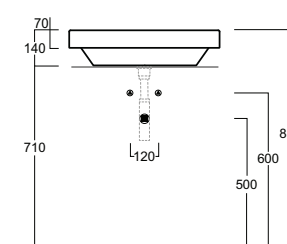
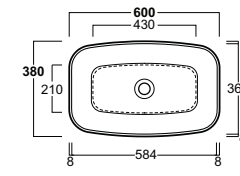
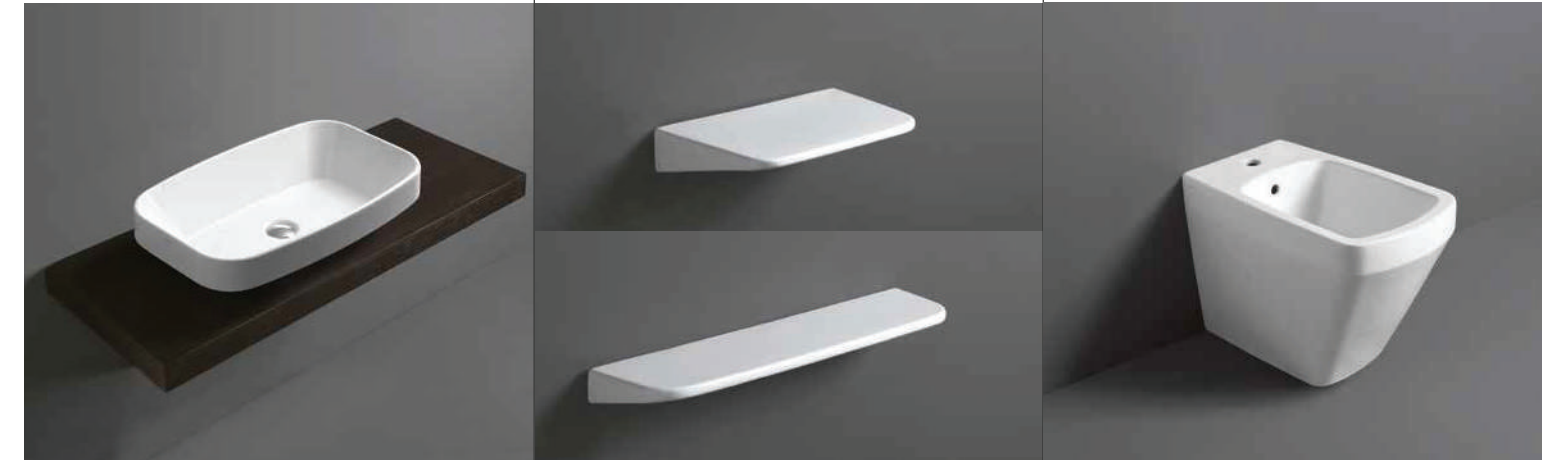
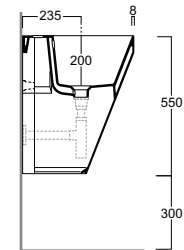
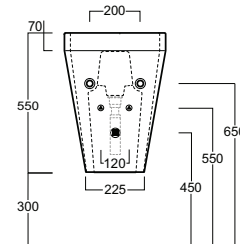
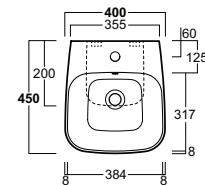
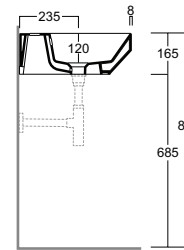
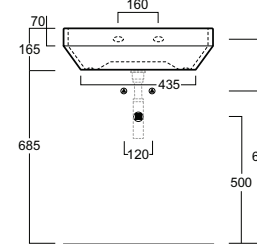
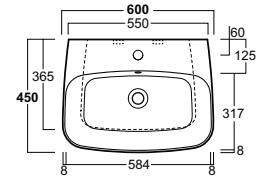
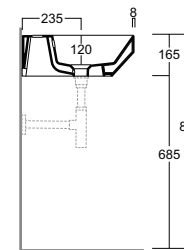
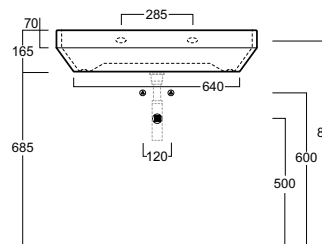
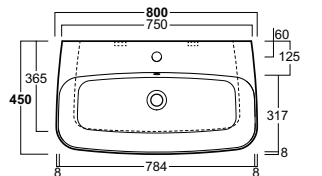
*Back to wall bidet with single tap hole. Complete with fixing set F 91.**Bidet mono trou caréné. Complet de set de fixation F 91.**Bidè, Einloch, verkleidet. Inklusive Befestigungsset F 91.**Биде с одним отверстием, обтекаемой формы. Комплектуется набором крепежей F 91.*

**BB 01/F 91**

kg 21

Vaso carenato "Rimless". Scarico parete o pavimento. Completo di set di fissaggio F 91.

"Rimless" back to wall WC. Wall or floor outlet. Complete with fixing set F 91.

Cuvette carénée "Rimless". Décharge au mur ou au sol. Complet de set de fixation F 91.

"Rimless" WC, verkleidet. Wand-oder Bodenanschluss. Befestigungsset F 91.

Унитаз обтекаемой формы "Rimless". Слив на стене или полу. Комплектуется набором крепежей F 91.

**BB 19 / F 87**

kg 13

Bidet sospeso monoforo. Completo di set di fissaggio F 87.

Wall hung bidet with single tap hole. Complete with fixing set F 87.

Bidet suspendu mono trou. Complet de set de fixation F 87.

Hänge-Bidet, Einloch. Inklusive Befestigungsset F 87.

Биде подвесное с одним отверстием. Комплектуется набором крепежей F 87.

**BB 18 / F 87**

kg 16

Vaso sospeso "Rimless". Completo di set di fissaggio F 87.

"Rimless" wall hung WC. Complete with fixing set F 87.

Cuvette suspendue "Rimless". Complet de set de fixation F 87.

"Rimless" Hänge-WC. Inklusive Befestigungsset F 87.

Унитаз подвесной "Rimless" вместе с крепежным комплектом F 87.

**CT 09 / D 20**

kg 23

Cassetta monoblocco con batteria di scarico. Per vaso EL 01 / LFT 20 / VI 01 / BB 01 / FL 61

Close coupled cistern with flush mechanism. For WC EL 01 / LFT 20 / VI 01 / BB 01 / FL 61

Caisse mono bloc avec batterie de décharge. Pour cuvette EL 01 / LFT 20 / VI 01 / BB 01 / FL 61

Monoblock-Spülkasten mit Abflussmechanik. Für WC EL 01 / LFT 20 / VI 01 / BB 01 / FL 61

Бачок моноблок с механизмом слива и специальным набором крепежей. Для унитазов EL 01 / LFT 20 / VI 01 / BB 01 / FL 61

**BB 003**

kg 2,1

Coprivaso in termoindurente cerniere cromo a sgancio rapido

Thermoset toilet seat with chrome-finish hinges quick-release

Abattant en thermo durcisseur charnières chromées declipsables

WC Deckel, thermoverformt, Chromscharniere "quick-release"

Сиденье быстросъемное из терморезины с петлями хром

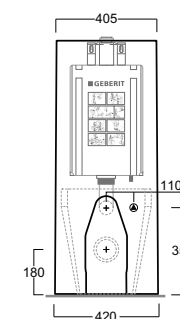
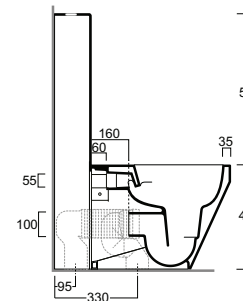
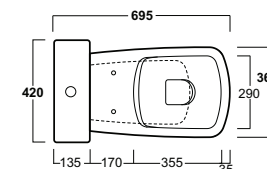
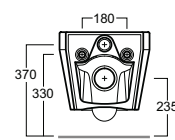
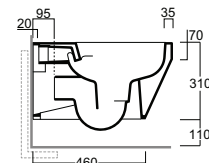
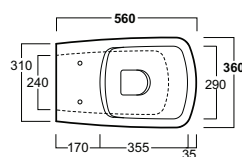
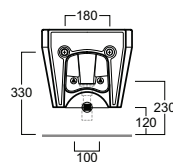
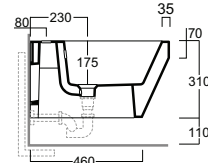
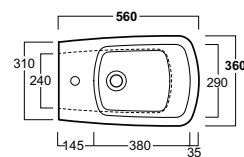
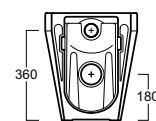
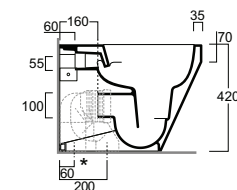
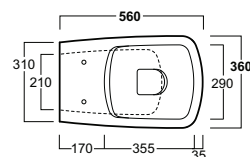
**BB 004**

kg 2,1

Coprivaso in termoindurente con cerniere rallentate cromo sgancio rapido

Thermoset toilet seat with chrome-finish soft-closing hinges quick-release

Abattant thermo durcisseur en thermo durcisseur avec charnières ralenties chromées declipsables

WC Deckel, thermoverformt, Chromscharniere mit Absenkautomatik quick-release

Сиденье с микролифтом быстросъемное из терморезины с петлями хром

## RIMLESS SYSTEM

RIMLESS System  
RIMLESS système  
RIMLESS System  
Система RIMLESS



RISPARMIO IDRICO  
WATER SAVING



PULIZIA FACILE E VELOCE  
EASY AND FAST CLEANING

Tutti i vasi Baden Baden sono rimless, ossia senza brida, cioè senza il bordo attraverso cui passa il risciacquo d'acqua che rappresenta circa il 20% del bacino interno del sanitario ed è generalmente di difficile pulizia. Il nuovo sistema di scarico determina un design molto più lineare e consente una pulizia più facile, efficace e senza schizzi, a garanzia di una migliore igiene. Con un effetto estetico sicuramente superiore.

All Baden Baden vases are rimless, i.e. without the edge through which the water passes, an edge that represents approximately 20% of the inner basin of the toilet, and is usually difficult to clean. The new flushing system results in a much more linear design that is easier to clean. Flushing is more effective, with less spray, for superior hygiene. And with a decidedly superior aesthetic effect.

Toutes les toilettes Baden Baden sont sans rabat, c'est-à-dire sans la partie à travers laquelle passe l'eau de rinçage représentant environ 20% de la cuvette interne, généralement difficile à nettoyer. Le nouveau système de chasse d'eau produit un design bien plus linéaire et permet un nettoyage plus facile, efficace et sans éclaboussures, en garantie d'une meilleure hygiène. Avec un effet esthétique nettement supérieur.

Alle Baden Baden WCs sind "rimless", d.h. ohne den Rand, durch den das Spülwasser verläuft, und der ca. 20% des Innenbeckens eines WCs ausmacht und meist relativ schwierig zu reinigen ist. Das neue Spülsystem hingegen ermöglicht ein deutlich lineares, reinigungsfreundlicheres Design, das effizient, spritzfrei und somit Garantie für mehr Hygiene ist. Und auch die Optik wird dadurch aufgewertet.

У унитазов Baden Baden нет бортиков, за которыми скрываются отверстия для смывной воды и которые порой составляют до 20% объема чаши. Из-за бортиков унитаза бывает трудно поддерживать в чистоте, а при новой системе ополаскивания не образуется брызг, гигиенический уход за унитазом становится простым и эффективным, а сама чаша приобретает простую и лаконичную форму, выигрывая в эстетичности.

## SYSTEM RENOVATE

RENOVATE System  
RENOVATE système  
RENOVATE System  
Система RENOVATE

BB01

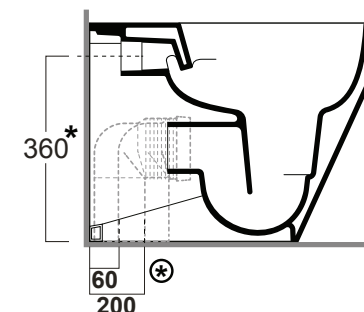

CT01 \*

Curva tecnica per lo scarico a pavimento regolabile da 6 a 11 cm

Curved pipe for floor outlet, adjustable from 6 to 11 cm

Courbe technique pour l'évacuation au sol, réglable de 6 à 11 cm

Wand-oder Bogenrohr zu Stand WC mit Abstand 6 – 11 cm

Техническое колено для вертикального слива, регулируемое от 6 до 11 см

BB01

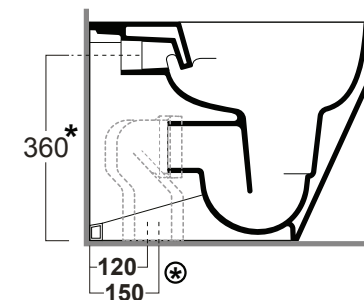

CT02 \*

Curva tecnica per lo scarico a pavimento regolabile da 12 a 15 cm

Curved pipe for floor outlet, adjustable from 12 to 15 cm

Courbe technique pour l'évacuation au sol, réglable de 12 à 15 cm

Wand-oder Bogenrohr zu Stand WC mit Abstand 12 – 15 cm

Техническое колено для вертикального слива, регулируемое от 12 до 15 см

BB01

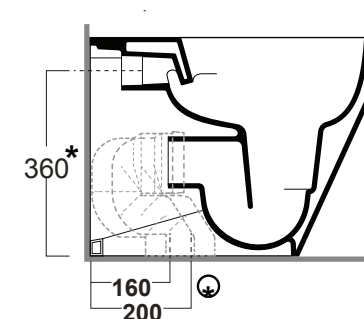

CT03 \*

Curva tecnica per lo scarico a pavimento regolabile da 16 a 20 cm

Curved pipe for floor outlet, adjustable from 16 to 20 cm

Courbe technique pour l'évacuation au sol, réglable de 16 à 20 cm

Wand-oder Bogenrohr zu Stand WC mit Abstand 16 – 20 cm

Техническое колено для вертикального слива, регулируемое от 16 до 20 см



CT04 \*

Raccordo eccentrico per ingresso acqua: h 34

Eccentric pipe for water inlet 34 cm

Raccord excentrique pour l'entrée de l'eau h 34 cm

Exenterstützen für Wasserzulauf Höhe 34 cm

Эксцентрический переход для входа воды: h 34 см

**DES2**

kg 4

Specchio sagomato 75 cm (bianco/grigio-argento)

*Shaped mirror 75 cm (white / silver-gray)**Miroir modélé 75 cm (blanc / gris argenté)**Gestalter spiegel 75 cm (weiß / silber-grau)**зеркало профилированное 75 см  
(белое/серебристо-серое)***DES1**

kg 2

Specchio sagomato 60 cm (bianco/grigio-argento)

*Shaped mirror 60 cm (white / silver-gray)**Miroir modélé 60 cm (blanc / gris argenté)**Gestalter spiegel 60 cm (weiß / silber-grau)**зеркало профилированное 60 см  
(белое/серебристо-серое)***F 89**

kg 0,18

Set viti di fissaggio per lavabo

*Set fixing screws for washbasin**Set de vis de fixation pour lavabo**Montageset Waschbecken**Комплект крепежных винтов для раковины***F 84**

kg 3

Coppia staffe di fissaggio per vaso o bidet sospesi

*A pair of brackets for wall hung wc or bidet**Paire d'équerres de fixation pour cuvette ou bidet suspendus**Paar Befestigungshalterungen für Wandklosett oder Wandbidets**Пара крепежных скоб для подвесных унитаза или биде***F 87**

kg 0,3

Set viti fissaggio per vaso, bidet o lavabo sospesi

*Fixing Kit for wall hung WC, bidet or washbasin**Jeu de vis de fixation pour cuvette, bidet ou lavabo suspendus**Satz Befestigungsschrauben für Wand-Klosett Bidet oder Waschbecken**Комплект крепежных винтов для подвесных унитаза, раковины и биде.***F 91**

kg 0,3

Set viti fissaggio a parete per vaso o bidet a terra

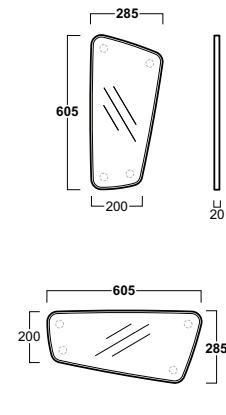
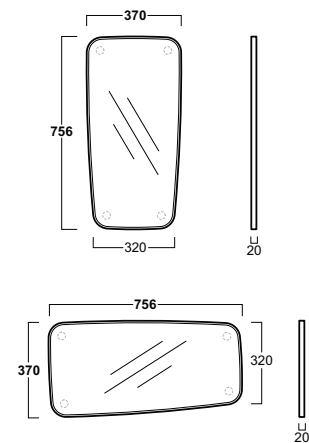
*Wall hung fixing kit for back to wall WC or bidet**Vis de fixation suspendues pour cuvette ou bidet à poser.**Wandhaengemontageset für verkleidete WC oder Bidet**Комплект винтов для крепления к стене напольных унитаза и биде.*

**SIF 165**

kg 1,1

Sifone cilindrico lavabo da 1<sup>1/4</sup>"*Cylindrical trap for washbasin 1<sup>1/4</sup>"**Siphon cylindrique pour lavabo de 1<sup>1/4</sup>"**Siphon, zylindrisch für Waschbecken 1<sup>1/4</sup>"**Сифон цилиндрической формы для раковин***SIF 270**

kg 1,4

Sifone cilindrico lavabo da 1<sup>1/4</sup>"*Cylindrical trap for washbasin 1<sup>1/4</sup>"**Siphon cylindrique pour lavabo de 1<sup>1/4</sup>"**Siphon, zylindrisch für Waschbecken 1<sup>1/4</sup>"**Сифон цилиндрической формы для раковин***SIF 125**

kg 1

Sifone cilindrico per bidet da 1<sup>1/4</sup>"*Cylindrical trap for bidet 1<sup>1/4</sup>"**Siphon cylindrique pour bidet de 1<sup>1/4</sup>"**Siphon, zylindrisch für Bidet 1<sup>1/4</sup>"**Цилиндрический сифон для биде 1<sup>1/4</sup>"***PLCR**

kg 0,4

Piletta "shut rapid" o "free flow" cromo

*Pop-up waste "shut rapid" or "free flow" chrome**Bonde "shut rapid" ou "free flow" chromée**Abflusstöpsel "Shut rapid" oder "free flow" chrom**Донный клапан типа "быстрый затвор" или "свободный поток" хром.***PLCE**

kg 0,5

Piletta "shut rapid" o "free flow" in ceramica\*

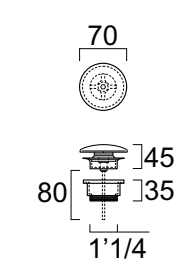
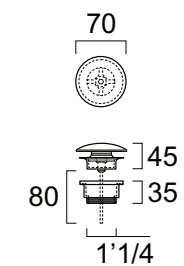
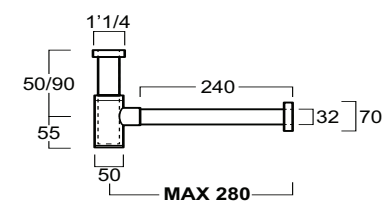
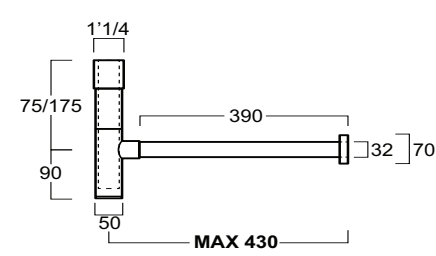
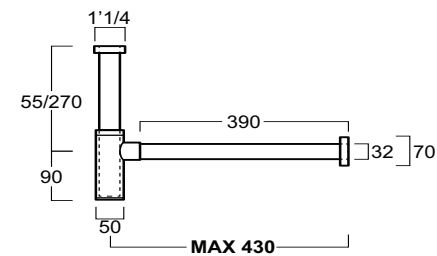
*Pop-up waste "shut rapid" or "free flow" ceramic**Bonde "shut rapid" ou "free flow" céramique**Abflusstöpsel "Shut rapid" oder "free flow" keramik**Донный клапан типа "быстрый затвор" или "свободный поток" керамика.*

\* Disponibile in tutti i colori  
*Available in all colors*  
*Disponible dans tous les coloris*  
*Verfügbare in alle die Farben*  
*В наличии все цвета*

# flow

DESIGN: TERRI PECORA

Un gusto diverso nell'arredare lo spazio e viverlo senza limiti. Una collezione minimale e dinamica nelle linee del design, dove convivono forme quadrate, ovali, rettangolari e tondeggianti. Creativa nelle soluzioni adottate. Funzionale in ogni singolo pezzo e nelle diverse possibilità di combinazione con accessori, specchi e mobili. Forma lo spazio per qualsiasi ambiente, dal piccolo al grande.

A flexible and architectural concept for a new taste in furnishing bathrooms. A minimalist and dynamic collection based on classic design elements - geometric shapes sharing common space - squares, ovals, rectangles, cylinders. Completely functional and creative solutions, Flow offers a variety of combinations with a full line of accessories. Ideally suited for any interior, small or large.

Un goût différent pour meubler l'espace et le vivre sans limite. Une collection minime et dynamique dans les lignes du design, où vivent ensemble des formes carrées, ovales, rectangulaires et rondes.

Créatives dans les solutions adoptées. Fonctionnelles dans chaque morceau et dans les différentes possibilités de combinaison d'accessoires, miroirs et meubles. Il forme l'espace pour n'importe quel milieu, du petit au grand.

Die andere Art den Raum einzurichten. Eine Kollektion, die minimal und dynamisch in seiner Linienggebung ist. Ein Zusammenspiel von quadratischen, ovalen, runden und rechteckigen Formen.

Vielfältig in seinen Anwendungen. Funktional in jedem Stück und in den Kombinationsmöglichkeiten mit den Accessoires, Spiegeln und Möbeln. Eine Lösung vom kleinsten bis zum größten Raum.

Другой подход к освоению пространства. Минималистическая и динамичная коллекция; в ее дизайнерских линиях сосуществуют различные формы: квадратные, овальные, прямоугольные и округлые. Креативная с точки зрения многообразия возможных вариантов. Функциональная в каждом отдельном моменте и в различных вариантах комбинирования аксессуаров, зеркал и мебели. Создает пространство для любого помещения, от маленького до большого.

> **FL 23**  
Lavabo 88 sospeso  
Wall hung washbasin 58

< **FL 61**  
Vaso carenato  
Back to wall WC

< **FL 62**  
Bidet carenato  
Back to wall bidet







FL 03 115x50x11

FL 02 88,5x50x11

FL 20 82x50x11

FL 21 57,5x50x11



FL 22 115x50x11

FL 23 88x50x11

FL 05 87x49,5x11

FL 04 63,5x49,5x11



FL 01 69x50x11

FL 16 49,5x40x13,5

FL 15 39,5x50x13,5

FL 17 52x42x13,5

FL 14 40x49,5x13,5



FL 24 49,5x49,5x11

FL 12 53x32x14

FL 11 43x43x14

FL 13 52x32x13

FL 10 43x43x14



FL 61 35,5x49,5x41

FL 62 35,5x49,5x41

FL 63 36x50x23

FL 64 36x50x23



CT 09 42x13,5x100,5

i dettagli arredano  
lo spazio.

Details embellish space.  
Les détails agrémentent l'espace.  
Details, die den Raum gestalten.  
Интерьер решают детали.

**> FL 21**  
Lavabo 57 sospeso  
Wall hung washbasin 57



**< FL 20**  
Lavabo 82 sospeso  
Wall hung washbasin 82



**< F L63**  
Vaso sospeso "Rimless"  
"Rimless" wall hung WC



**< FL 64**  
Bidet sospeso  
Wall hung Bidet



**FL 02**

Lavabo 88 rettangolare sospeso mensola destra  
 Rectangular wall hung washbasin 88 with right shelf  
 Lavabo 88 rectangulaire suspendu étagère droite  
 Hängewaschbecken 88, rechteckig, Ablage recht  
 Раковина 88 прямоугольная подвесная с полкой dx  
 с одним намеченным отверстием

**FL 03**

Lavabo 115 rettangolare sospeso mensola sinistra  
 Rectangular wall hung washbasin 115 with left shelf  
 Lavabo 115 rectangulaire suspendu étagère gauche  
 Hängewaschbecken 115, rechteckig, Ablage links  
 Раковина 115 прямоугольная подвесная с полкой sx  
 с одним намеченным отверстием

**ACCESSORI DI COMPLETAMENTO**  
**ACCESSORIES AVAILABLE**

**FL 35** Portasciugamani cm 27 (FL02 - FL03)  
 Towel rail cm 27 (FL02 - FL03)  
**FL 36** Portasciugamani cm 40 (FL03)  
 Towel rail cm 40 (FL03)

**FL 21**

Lavabo 57 quadrato sospeso mensola destra  
 Square wall hung washbasin 57 with right shelf  
 Lavabo 57 carré suspendu étagère droite  
 Hängewaschbecken 57, quadratisch, Ablage recht  
 Раковина 57 квадратная подвесная с полкой dx

**FL 20**

Lavabo 82 quadrato sospeso mensola sinistra  
 Square wall hung washbasin 82 with left shelf  
 Lavabo 82 carré suspendu étagère gauche  
 Hängewaschbecken 82, quadratisch, Ablage links  
 Раковина 82 квадратная подвесная с полкой sx

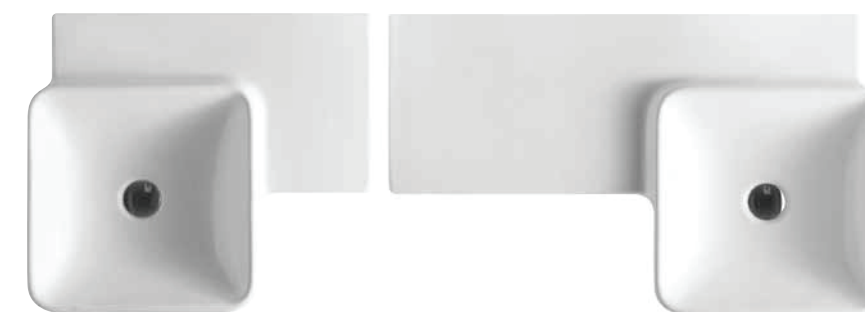

**ACCESSORI DI COMPLETAMENTO**  
**ACCESSORIES AVAILABLE**

**FL 35** Portasciugamani cm 27 (FL20 - FL21)  
 Towel rail cm 27 (FL20 - FL21)  
**FL 36** Portasciugamani cm 40 (FL20)  
 Towel rail cm 40 (FL20)

**FL 23**

Lavabo 88 ovale sospeso mensola destra  
 Oval wall hung washbasin 88 with right shelf  
 Lavabo 88 ovale suspendu étagère droite  
 Hängewaschbecken 88, oval, Ablage recht  
 Раковина 88 овальная подвесная с полкой dx

**FL 04**

Lavabo 63 tondo sospeso mensola destra  
 Round wall hung washbasin 63 with right shelf  
 Lavabo 63 rond suspendu étagère droite  
 Hängewaschbecken 63, rund, Ablage recht  
 Раковина 63 круглая подвесная с полкой dx

**FL 05**

Lavabo 87 tondo sospeso mensola sinistra  
 Round wall hung washbasin 87 with left shelf  
 Lavabo 87 rond suspendu étagère gauche  
 Hängewaschbecken 87, rund, Ablage links  
 Раковина 87 круглая подвесная с полкой sx

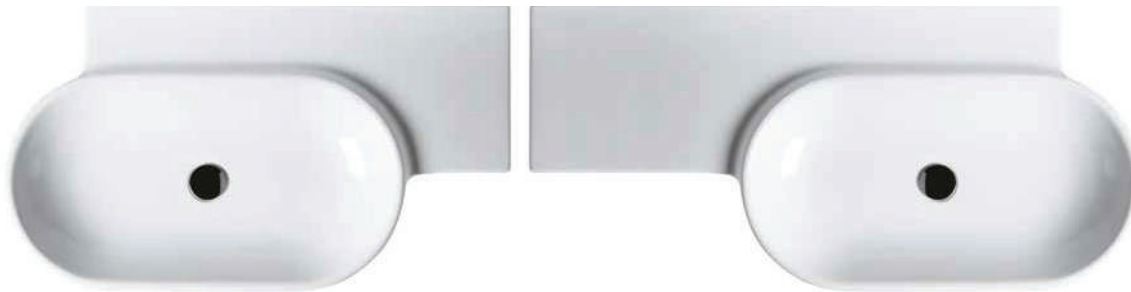
**FL 23**

Lavabo 88 ovale sospeso mensola destra  
 Oval wall hung washbasin 88 with right shelf

**FL 22**

Lavabo 115 ovale sospeso mensola sinistra  
 Oval wall hung washbasin 115 with left shelf

**ACCESSORI DI COMPLETAMENTO**  
**ACCESSORIES AVAILABLE**

**FL 35** Portasciugamani cm 27 (FL 22 - FL 23)  
 Towel rail cm 27 (FL 22 - FL 23)  
**FL 36** Portasciugamani cm 40 (FL 23)  
 Towel rail cm 40 (FL 23)



**ACCESSORI DI COMPLETAMENTO**  
**ACCESSORIES AVAILABLE**

**FL 35** Portasciugamani cm 27 (FL 22 - FL 23)  
 Towel rail cm 27 (FL 22 - FL 23)  
**FL 36** Portasciugamani cm 40 (FL 23)  
 Towel rail cm 40 (FL 23)

**FL 01**

Lavabo 69 rettangolare sospeso  
*Rectangular wall hung washbasin 69*  
 Lavabo 69 rectangulaire suspendu  
 Hängewaschbecken 69, rechteckig  
 Раковина 69 прямоугольная подвесная

**FL 35**

Porta asciugamani 27 da parete o lavabo  
*Wall or washbasin towel rail 27*  
 Porte serviette 27 à mur ou lavabo  
 Handtuchhalter 27, Wand- oder Beckenmontage  
 Полка для полотенец настенная, либо для раковины. Соответственно 27см

**FL 16**

Lavabo 49 rettangolare sospeso  
*Rectangular wall hung washbasin 49*  
 Lavabo 49 rectangulaire suspendu  
 Hängewaschbecken 49, rechteckig  
 Раковина 49 прямоугольная подвесная



**ACCESSORI DI COMPLETAMENTO**  
**ACCESSORIES AVAILABLE**

**FL 35** Portasciugamani cm 27 (FL 01 - FL 15 - FL 16)  
 Towel rail cm 27 (FL 01 - FL15 -FL 16)

**FL 15**

Lavabo 39 quadrato sospeso  
 Square wall hung washbasin 39  
 Lavabo 39 carré suspendu  
 Hängewaschbecken 39, quadratisch  
 Раковина 39 квадратная подвесная



**ACCESSORI DI COMPLETAMENTO**  
**ACCESSORIES AVAILABLE**

**FL 35** Portasciugamani cm 27 (FL 17)  
 Towel rail cm 27 (FL 17)  
**FL 36** Portasciugamani cm 40 (FL 17)  
 Towel rail cm 40 (FL 17)

**FL 17**

Lavabo 52 ovale sospeso  
 Oval wall hung washbasin 52  
 Lavabo 52 ovale suspendu  
 Ovaler Waschtisch hängend 52  
 Раковина 52 овальная подвесная с одним намеченным отверстием

**FL 14**

Lavabo 40 tondo sospeso  
 Round wall hung washbasin 40

**FL 17**

Lavabo 52 ovale sospeso  
 Oval wall hung washbasin 52

**ACCESSORI DI COMPLETAMENTO**  
**ACCESSORIES AVAILABLE**

**FL 35** Portasciugamani cm 27 (FL 17)  
 Towel rail cm 27 (FL 17)  
**FL 36** Portasciugamani cm 40 (FL 17)  
 Towel rail cm 40 (FL 17)

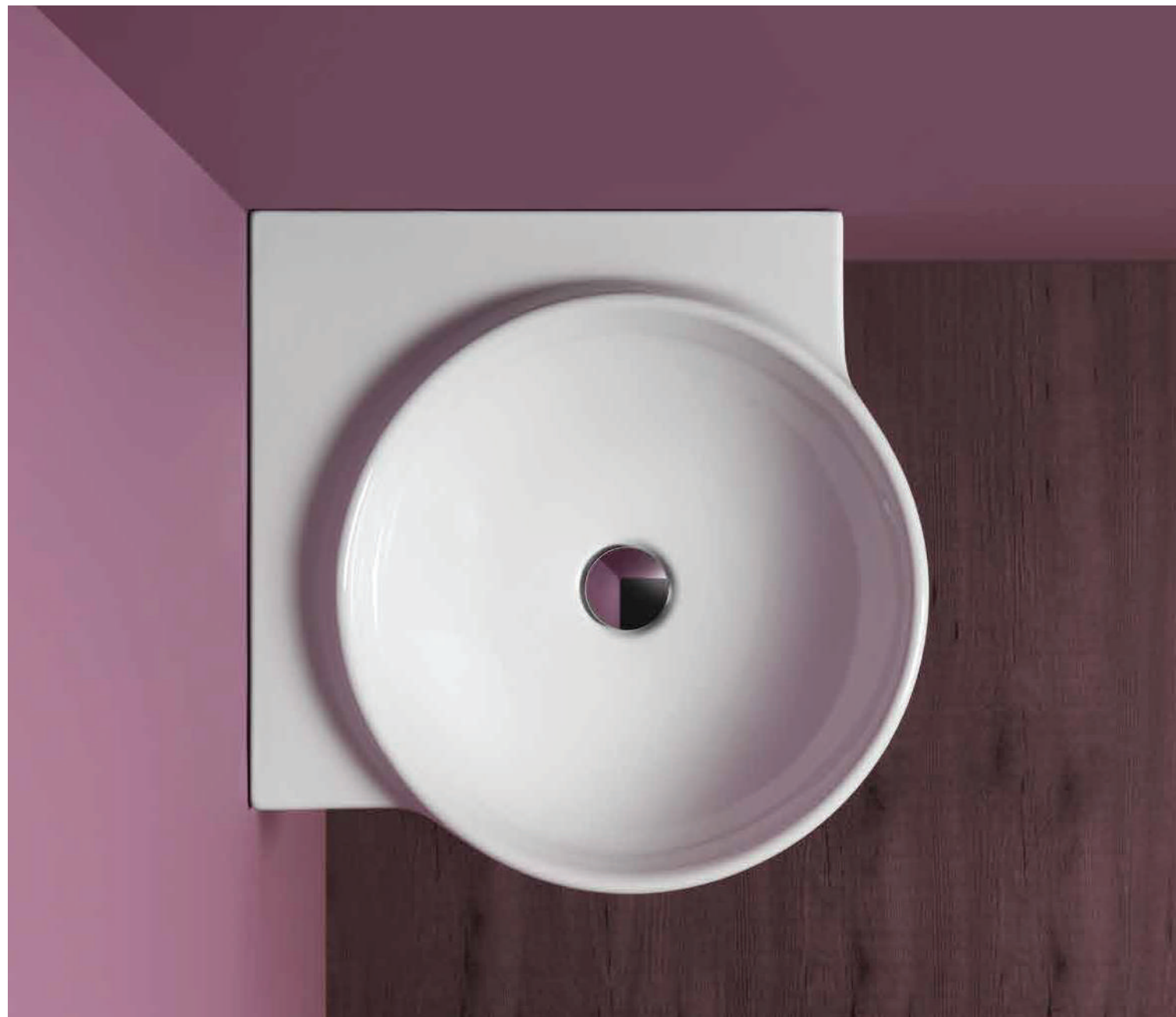
**FL 24**

Lavabo 49 ad angolo sospeso  
 Corner wall hung washbasin 49  
 Lavabo 49 à angle  
 Eckwaschbecken 49  
 Раковина 49 угловая с одним намеченным отверстием

**FL 10**

Lavabo 43 tondo da appoggio  
 Round counter top washbasin 43  
 Lavabo d'appui rond 43  
 Aufsatzwaschbecken, rund 43  
 Раковина 43 накладная круглая

**FL 10**

Lavabo 43 tondo da appoggio  
 Round counter top washbasin 43

**FL 13**

Lavabo 52 ovale da appoggio  
 Oval counter top washbasin 52



**FL 11**

Lavabo 43 quadrato da appoggio  
 Square counter top washbasin 43  
 Lavabo 43 d'appui carré  
 Aufsatzwaschbecken, quadratisch 43  
 Раковина 43 накладная квадратная

**FL 11**

Lavabo 43 quadrato da appoggio  
 Square counter top washbasin 43

**FL 12**

Lavabo 53 rettangolare da appoggio  
 Rectangular counter top washbasin 43

**FL 63**

Vaso sospeso "Rimless". Completo di set di fissaggio F 85  
 "Rimless" wall hung WC. Complete with fixing set F 85  
 Cuvette suspendue "Rimless". Complet de set de fixation F 85  
 "Rimless" Hänge-WC. Inklusive Befestigungsset F 85  
 Унитаз подвесной "Rimless" вместе с крепежным комплектом F 85

**FL 64**

Bidet sospeso monoforo. Completo di set di fissaggio F 85  
 Wall hung bidet with single tap hole. Complete with fixing set F 85  
 Bidet suspendu mono trou. Complet de set de fixation F 85  
 Hänge-Bidet, Einloch. Inklusive Befestigungsset F 85  
 Биде подвесное с одним отверстием. Комплектуется набором крепежей F 85



**ACCESSORI DI COMPLETAMENTO**  
**ACCESSORIES AVAILABLE**

**FL 28** Coprivaso avvolgente in termoindurente con cerniere rallentate cromo  
 Wrap-around thermoset toilet seat with chrome-finish soft-closing hinges



**FL 62**

Bidet monoforo quadrato carenato  
 Back to wall square bidet with single tap hole  
 Bidet mono trou carré caréné  
 Bidet, quadratisch, Einloch, verkleidet  
 Биде приставное квадратное с одним отверстием

**FL 61**

Vaso carenato con scarico parete o pavimento  
 Back to wall WC with wall or floor outlet  
 Cuvette carénée décharge au mur ou au sol  
 WC, verkleidet. Wand- oder Bodenanschluss  
 Унитаз приставной. Горизонтальный или вертикальный слив



**ACCESSORI DI COMPLEMENTAMENTO**  
**ACCESSORIES AVAILABLE**

**FL 27** Coprivaso quadrato in poliestere con cerniere cromo  
 Square polyster toilet seat with chrome-finish hinges

**FL 61**

Vaso carenato con scarico parete o pavimento  
 Back to wall WC with wall or floor outlet  
 Cuvette carénée décharge au mur ou au sol  
 WC, verkleidet. Wand- oder Bodenanschluss  
 Унитаз приставной. Горизонтальный или вертикальный слив

**CT 09 / D 20**

Cassetta monoblocco con batteria di scarico  
 e apposito set di fissaggio  
 Close coupled cistern with flush mechanism  
 and special fixing set  
 Caisse mono bloc avec batterie de décharge  
 et spécial kit de fixation  
 Monoblock-Spülkasten mit Abflussmechanik  
 und Befestigungsset  
 Бачок моноблок с механизмом слива  
 и специальным набором крепежей

**ACCESSORI DI COMPLEMENTAMENTO**  
**ACCESSORIES AVAILABLE**

**FL 27** Coprivaso quadrato in poliestere con cerniere cromo  
 Square polyster toilet seat with chrome-finish hinges



**FL 01**

kg 18

Lavabo 69 rettangolare sospeso predisposto monoforo

*Rectangular wall hung washbasin 69 pre-punched for single tap hole*

*Lavabo 69 rectangulaire suspendu prédisposé mono trou*

*Hängewaschbecken 69, rechteckig, für Einlocharmatur*

*Раковина 69 прямоугольная подвесная с одним намеченным отверстием*

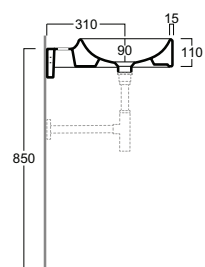
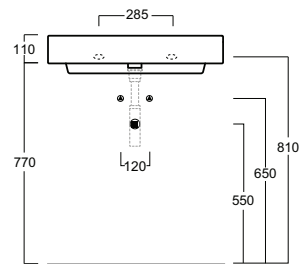
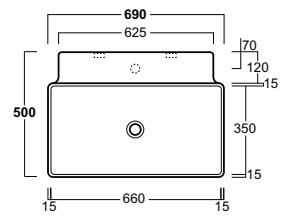
**FL 02**

kg 21

Lavabo 88 rettangolare sospeso mensola destra predisposto monoforo

*Rectangular wall hung washbasin 88 with right shelf pre-punched for single tap hole*

*Lavabo 88 rectangulaire suspendu étagère droite prédisposé mono trou*

*Hängewaschbecken 88, rechteckig, Ablage recht, für Einlocharmatur*

*Раковина 88 прямоугольная подвесная с полкой dx с одним намеченным отверстием*

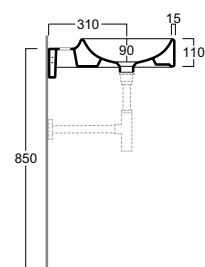
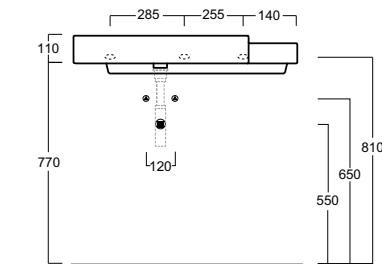
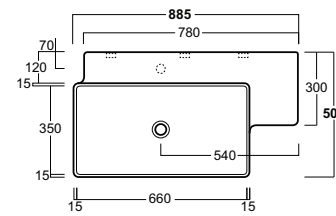
**FL 03**

kg 25

Lavabo 115 rettangolare sospeso mensola sinistra predisposto monoforo

*Rectangular wall hung washbasin 115 with left shelf pre-punched for single tap hole*

*Lavabo 115 rectangulaire suspendu étagère gauche prédisposé mono trou*

*Hängewaschbecken 115, rechteckig, Ablage links, für Einlocharmatur*

*Раковина 115 прямоугольная подвесная с полкой sx с одним намеченным отверстием*

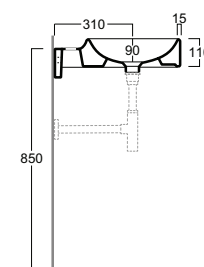
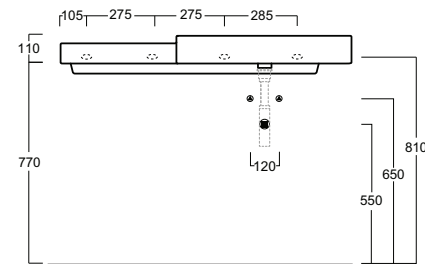
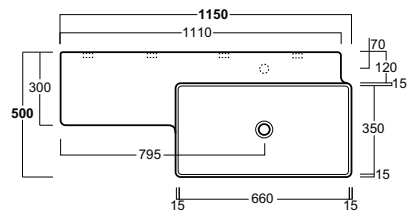
**FL 04**

kg 13

Lavabo 63 tondo sospeso mensola destra predisposto monoforo

*Round wall hung washbasin 63 with right shelf pre-punched for single tap hole*

*Lavabo 63 rond suspendu étagère droite prédisposé mono trou*

*Hängewaschbecken 63, rund, Ablage recht, für Einlocharmatur*

*Раковина 63 круглая подвесная с полкой dx с одним намеченным отверстием*

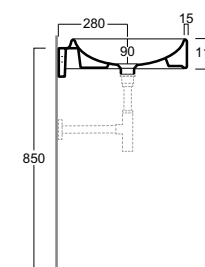
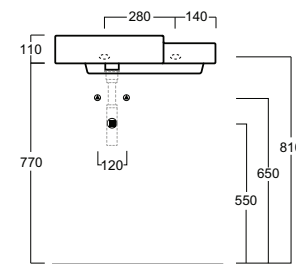
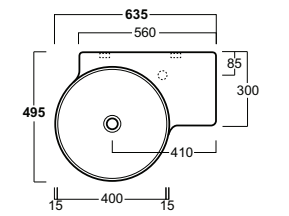
**FL 05**

kg 18

Lavabo 87 tondo sospeso mensola sinistra predisposto monoforo

*Round wall hung washbasin 87 with left shelf pre-punched for single tap hole*

*Lavabo 87 rond suspendu étagère gauche prédisposé mono trou*

*Hängewaschbecken 87, rund, Ablage links, für Einlocharmatur*

*Раковина 87 круглая подвесная с полкой sx с одним намеченным отверстием*

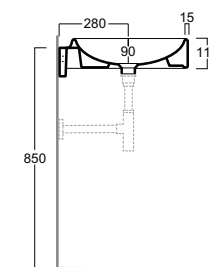
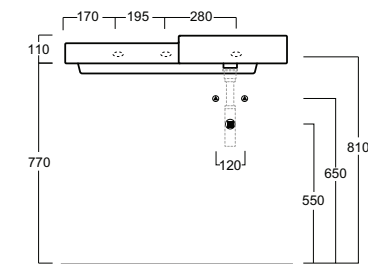
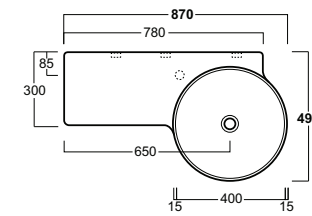
**FL 22**

kg 23

Lavabo 115 ovale sospeso mensola sinistra predisposto monoforo

*Oval wall hung washbasin 115 with left shelf pre-punched for single tap hole*

*Lavabo 115 ovale suspendu étagère gauche prédisposé mono trou*

*Hängewaschbecken 115, oval, Ablage links, für Einlocharmatur*

*Раковина 115 овальная подвесная с полкой sx с одним намеченным отверстием*

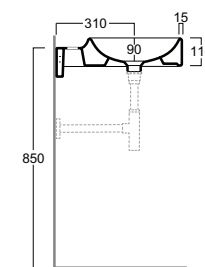
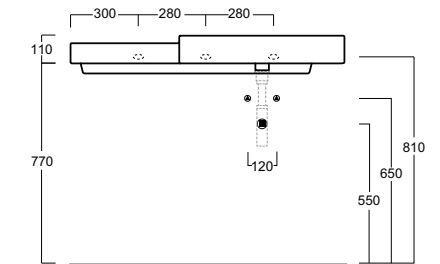
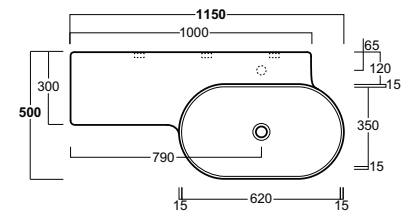

**FL 23**

kg 20

Lavabo 88 ovale sospeso mensola destra predisposto monoforo

*Oval wall hung washbasin 88 with right shelf pre-punched for single tap hole*

*Lavabo 88 ovale suspendu étagère droite prédisposé mono trou*

*Hängewaschbecken 88, oval, Ablage recht, für Einlocharmatur*

*Раковина 88 овальная подвесная с полкой dx с одним намеченным отверстием*

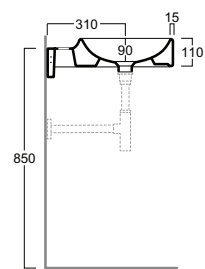
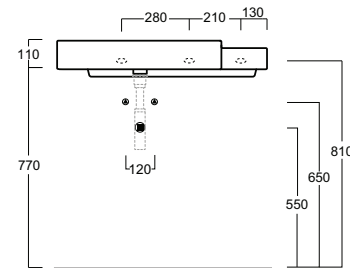
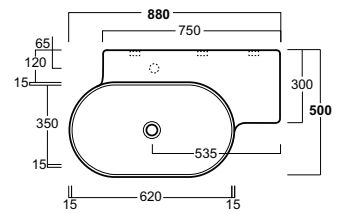
**FL 20**

kg 17

Lavabo 82 quadrato sospeso mensola sinistra predisposto monoforo

*Square wall hung washbasin 82 with left shelf pre-punched for single tap hole*

*Lavabo 82 carré suspendu étagère gauche prédisposé mono trou*

*Hängewaschbecken 82, quadratisch, Ablage links, für Einlocharmatur*

*Раковина 82 квадратная подвесная с полкой sx с одним намеченным отверстием*

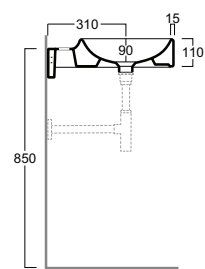
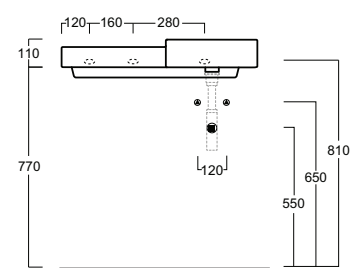
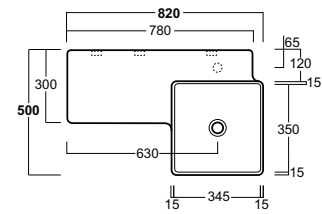
**FL 21**

kg 13

Lavabo 57 quadrato sospeso mensola destra predisposto monoforo

*Square wall hung washbasin 57 with right shelf pre-punched for single tap hole*

*Lavabo 57 carré suspendu étagère droite prédisposé mono trou*

*Hängewaschbecken 57, quadratisch, Ablage recht, für Einlocharmatur*

*Раковина 57 квадратная подвесная с полкой dx с одним намеченным отверстием*

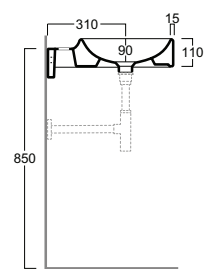
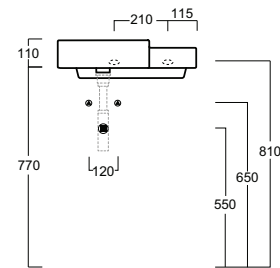
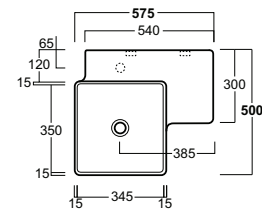
**FL 24**

kg 12

Lavabo 49 ad angolo sospeso predisposto monoforo

*Corner wall hung washbasin 49 pre-punched for single tap hole*

*Lavabo 49 à angle prédisposé mono trou*

*Eckwaschbecken 49, für Einlocharmatur*

*Раковина 49 угловая с одним намеченным отверстием*

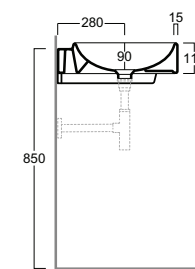
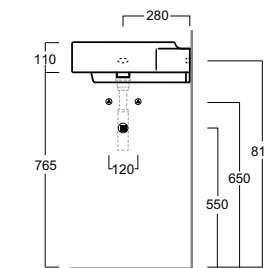
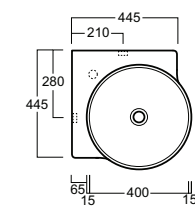
**FL 14**

kg 10

Lavabo 40 tondo sospeso predisposto monoforo

*Round wall hung washbasin 40 pre-punched for single tap hole*

*Lavabo 40 rond suspendu prédisposé mono trou*

*Hängewaschbecken 40, rund, für Einlocharmatur*

*Раковина 40 круглая подвесная с одним намеченным отверстием*

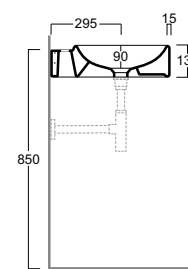
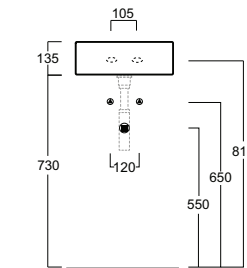
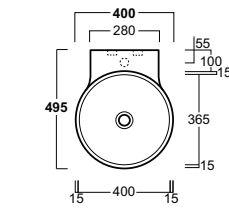
**FL 15**

kg 11

Lavabo 39 quadrato sospeso predisposto monoforo

*Square wall hung washbasin 39 pre-punched for single tap hole*

*Lavabo 39 carré suspendu prédisposé mono trou*

*Hängewaschbecken 39, quadratisch, für Einlocharmatur*

*Раковина 39 квадратная подвесная с одним намеченным отверстием*

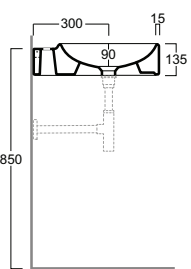
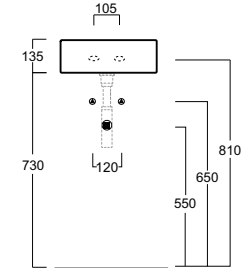
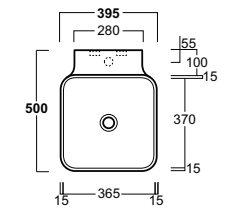

**FL 16**

kg 11

Lavabo 49 rettangolare sospeso predisposto monoforo

*Rectangular wall hung washbasin 49 pre-punched for single tap hole*

*Lavabo 49 rectangulaire suspendu prédisposé mono trou*

*Hängewaschbecken 49, rechteckig, für Einlocharmatur*

*Раковина 49 прямоугольная подвесная с одним намеченным отверстием*

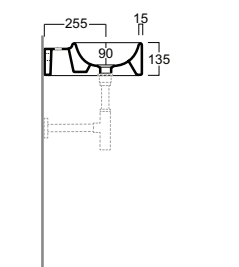
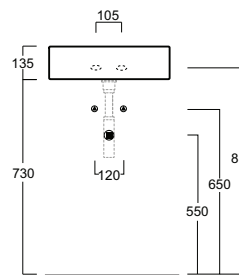
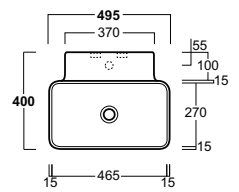
**FL 17**

kg 11

Lavabo 52 ovale sospeso predisposto monoforo

*Oval wall hung washbasin 52 pre-punched for single tap hole*

*Lavabo 52 ovale suspendu prédisposé mono trou*

*Hängewaschbecken 52, oval, für Einlocharmatur*

*Раковина 52 овальная подвесная с одним намеченным отверстием*

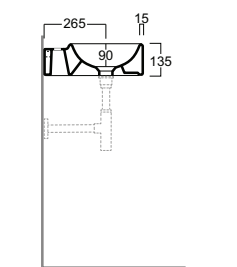
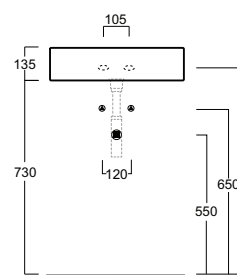
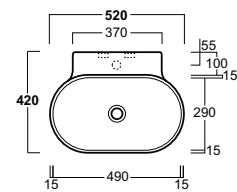
**FL 10**

kg 7

Lavabo 43 tondo da appoggio

*Round counter top washbasin 43*

*Lavabo 43 d'appui rond*

*Aufsatzwaschbecken 43, rund*

*Раковина 43 накладная круглая*

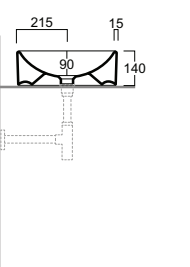
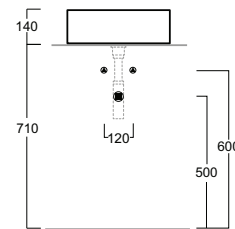
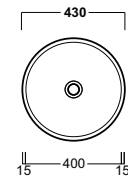
**FL 11**

kg 8

Lavabo 43 quadrato da appoggio

*Square counter top washbasin 43*

*Lavabo 43 d'appui carré*

*Aufsatzwaschbecken 43, quadratisch*

*Раковина 43 накладная квадратная*

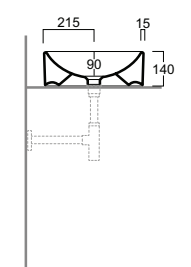
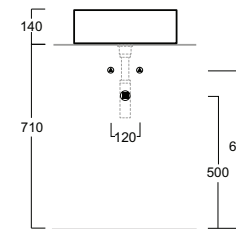
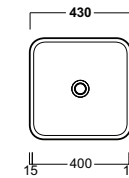
**FL 12**

kg 8

Lavabo 53 rettangolare da appoggio

*Rectangular counter top washbasin 53*

*Lavabo 53 d'appui rectangulaire*

*Aufsatzwaschbecken 53, rechteckig*

*Раковина 53 накладная прямоугольная*

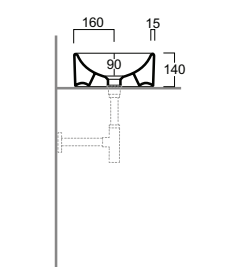
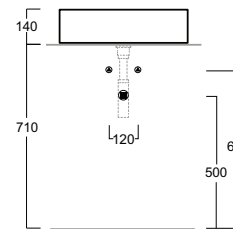
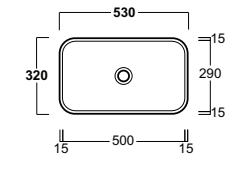
**FL 13**

kg 9

Lavabo 52 ovale da appoggio

*Oval counter top washbasin 52*

*Lavabo 52 d'appui ovale*

*Aufsatzwaschbecken 52, oval*

*Раковина 52 накладная овальная*

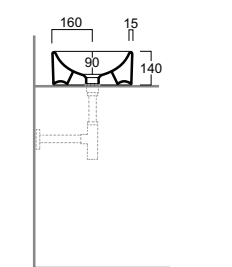
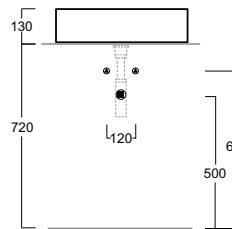
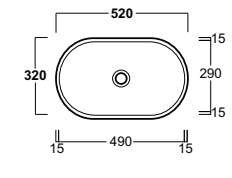

**FL 64 / F 85**

kg 16

Bidet sospeso monoforo. Completo di set di fissaggio F 85

Wall hung bidet with single tap hole. Complete with fixing set F 85

Bidet mono trou suspendu. Complet de set de fixation F 85

Hänge-Bidet, Einloch. Inklusive Befestigungsset F 85

Биде квадратное подвесное с одним отверстием

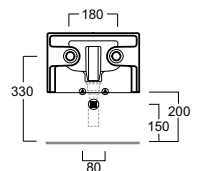
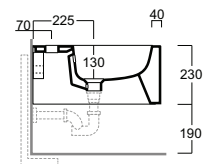
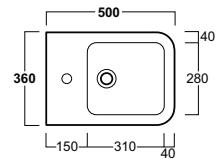
**FL 63 / F 85**

kg 20

Vaso sospeso "Rimless". Completo di set di fissaggio F 85

"Rimless" wall hung WC. Complete with fixing set F 85

Cuvette suspendue "Rimless". Complet de set de fixation F 85

"Rimless" Hänge-WC. Inklusive Befestigungsset F 85

Унитаз подвесной "Rimless". Комплектуется набором крепежей F 85

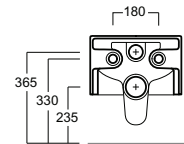
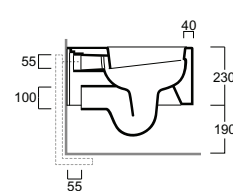
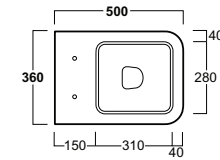
**FL 62**

kg 20

Bidet monoforo quadrato carenato

Back to wall square bidet with single tap hole

Bidet mono trou carré caréné

Bidet, quadratisch, Einloch, verkleidet

Биде приставное квадратное с одним отверстием

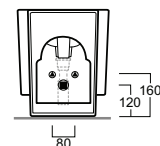
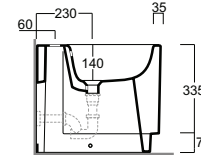
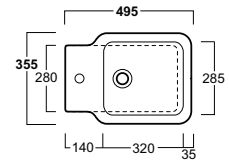
**FL 61**

kg 23

Vaso quadrato carenato. Scarico parete o pavimento (curva tecnica inclusa)

Back to wall square WC. Wall or floor outlet (curved pipe included)

Cuvette carrée carénée. Décharge à mur ou au sol (courbe technique incluse)

WC, quadratisch, verkleidet. Wand- oder Bodenanschluss (Inklusive Bogenrohr)

Унитаз приставной квадратный. Горизонтальный или вертикальный слив

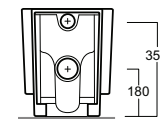
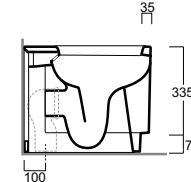
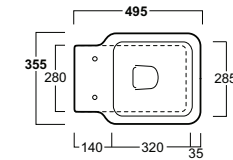
**CT 09 / D 20**

kg 12

Cassetta monoblocco con batteria di scarico. Per vaso EL 01 / LFT 20 / VI 01 / BB 01 / FL 61

Close coupled cistern with flush mechanism. For WC EL 01 / LFT 20 / VI 01 / BB 01 / FL 61

Caisse mono bloc avec batterie de décharge. Pour cuvette EL 01 / LFT 20 / VI 01 / BB 01 / FL 61

Monoblock-Spülkasten mit Abflussmechanik. Für WC EL 01 / LFT 20 / VI 01 / BB 01 / FL 61

Бачок моноблок с механизмом слива и специальным набором крепежей. Для унитазов EL 01 / LFT 20 / VI 01 / BB 01 / FL 61

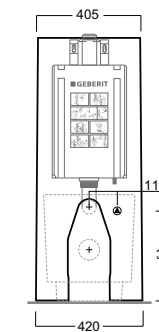
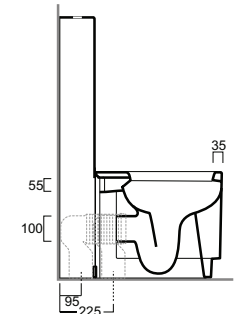
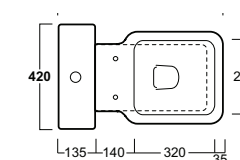
**FL 27**

kg 3,8

Coprivaso quadrato in poliestere con cerniere cromo per FL 61

Square polyester toilet seat with chrome-finish hinges for FL 61

Abtattung en polyester avec des charnières chrome pour FL 61

WC Deckel, quadratisch, in Polyester, Chromscharniere, für FL 61

Сиденье квадратное, полиэстер, шарниры хром, для FL 61



**FL 28**

kg 2,8

Coprivaso avvolgente in termoidurente con cerniere rallentate cromo per FL 63

Wrap-around thermostet toilet seat with chrome-finish soft-closing hinges for FL 63

Abattant enveloppant en thermo durcisseur avec des charnières ralenties chrome pour FL 63

WC Deckel, in thermoverformt, Chromscharniere mit Absenkautomatik für FL 63

Квадратная крышка для унитаза из термореактопласта, с хромированными шарнирными петлями с механизмом плавного опускания для FL 63

**F 84**

kg 3

Coppia staffe di fissaggio per vaso o bidet sospesi

A pair of brackets for wall hung wc or bidet

Paire d'équerres de fixation pour cuvette ou bidet suspendus

Paar Befestigungshalterungen für Wandklosett oder Wandbidets

Пара крепёжных скоб для подвесных унитаза или биде

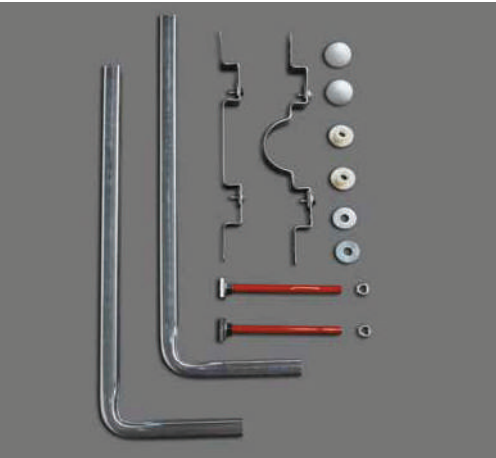
**F 85**

kg 0,3

Set viti fissaggio a completamento staffe F 84 per vaso o bidet sospeso

Fixing Kit for F 84 brackets for wall hung WC or bidet

Jeu de vis de fixation pour équerre F 84 pour cuvette ou bidet suspendu

Satz Befestigungsschrauben zur Ergänzung der Halterungen F 84 Wandklosett oder Wandbidet

Комплект крепежных винтов для комплектования скоб F 84 для подвесного унитаза или биде

**FL 35**

kg 0,5

Porta asciugamani 27 da parete o lavabo

Wall or washbasin towel rail 27

Porte serviette 27 à mur ou lavabo

Handtuchhalter 27, Wand- oder Beckenmontage

Полка для полотенец настенная, либо для раковины. Соответственно 27см

For art.: FL 01 - FL 02 - FL 03 - FL 04 - FL 05 - FL 15 - FL 16 - FL 17 - FL 20 - FL 21 - FL 22 - FL 23

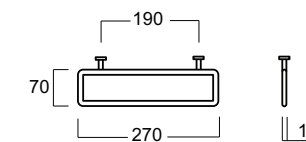
**FL 36**

kg 0,8

Porta asciugamani 40 da parete o lavabo

Wall or washbasin towel rail 40

Porte serviette 40 à mur ou lavab

Handtuchhalter 40, Wand- oder Beckenmontage

Полка для полотенец настенная, либо для раковины. Соответственно 40 см

For art.: FL 03 - FL 05 - FL 17 - FL 20 - FL 22

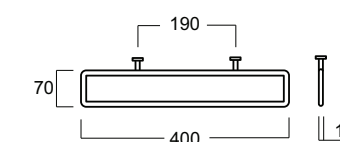
**SIF 165**

kg 1,1

Sifone cilindrico lavabo da 1 1/4"

Cylindrical trap for washbasin 1 1/4"

Siphon cylindrique pour lavabo de 1 1/4"

Siphon, zylindrisch für Waschbecken 1 1/4"

Сифон цилиндрической формы для раковин

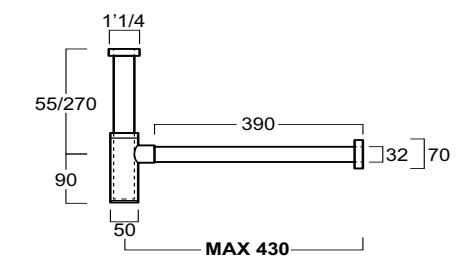

**SIF 270**

kg 1,4

Sifone cilindrico lavabo da 1<sup>1/4</sup>"*Cylindrical trap for washbasin 1<sup>1/4</sup>"**Siphon cylindrique pour lavabo de 1<sup>1/4</sup>"**Siphon, zylindrisch für Waschbecken 1<sup>1/4</sup>"**Сифон цилиндрической формы для раковин***SIF 125**

kg 1

Sifone cilindrico per bidet da 1<sup>1/4</sup>"*Cylindrical trap for bidet 1<sup>1/4</sup>"**Siphon cylindrique pour bidet de 1<sup>1/4</sup>"**Siphon, zylindrisch für Bidet 1<sup>1/4</sup>"**Цилиндрический сифон для биде 1<sup>1/4</sup>"***PLCR**

kg 0,4

Piletta "shut rapid" o "free flow" cromo

*Pop-up waste "shut rapid" or "free flow" chrome**Bonde "shut rapid" ou "free flow" chromée**Abflusstöpsel "Shut rapid" oder "free flow" chrom**Донный клапан типа "быстрый затвор" или "свободный поток" хром.***PLCE**

kg 0,5

Piletta "shut rapid" o "free flow" in ceramica

*Pop-up waste "shut rapid" or "free flow" ceramic**Bonde "shut rapid" ou "free flow" céramique**Abflusstöpsel "Shut rapid" oder "free flow" keramik**Донный клапан типа "быстрый затвор" или "свободный поток" керамика.***F 89**

kg 0,18

Set viti di fissaggio per lavabo

*Set fixing screws for washbasin**Set de vis de fixation pour lavabo**Montageset Waschbecken**Комплект крепежных винтов для раковины***F 88**

kg 0,12

Set viti di fissaggio laterali cromo/bianco per vaso o bidet

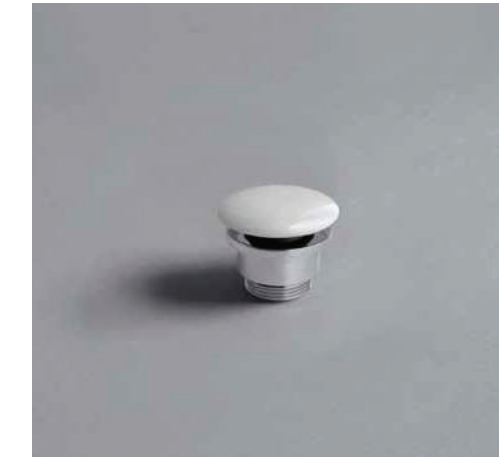
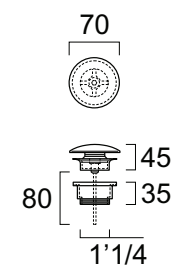
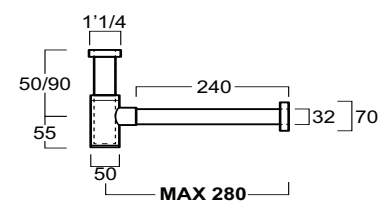
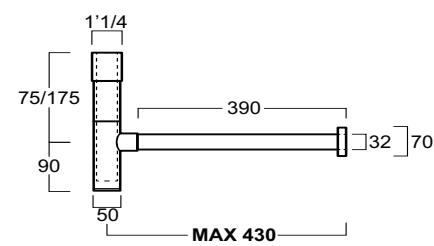
*Set of chrome/white lateral fixing screws for wc or bidet**Set de vis de fixation latérales chromées/blanc pour WC ou bidet**Montageset seitliche Montage weiss/chrom für WC oder Bidet**Комплект боковых крепежных винтов хром/белый для унитаза или биде*

\* Disponibile in tutti i colori  
 Available in all colors  
 Disponible dans tous les coloris  
 Verfüegbar in alle die Farben  
 В наличии все цвета

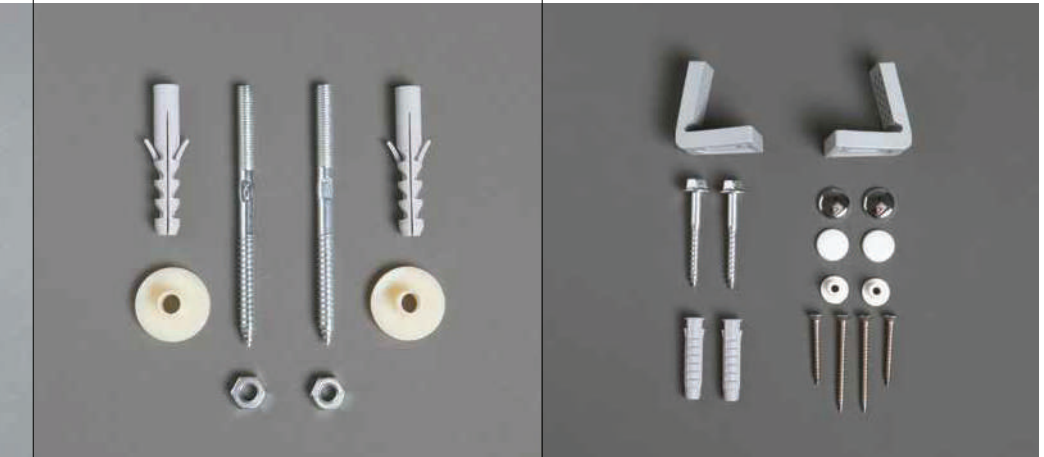
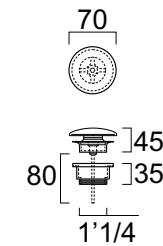

# frozen

DESIGN: UFFICIO TECNICO

Design senza compromessi per sculture da bagno. Una collezione che vince la sfida: produrre un ambiente dalle forme interamente squadrate, ottenute grazie a una lavorazione di altissimo rigore. Difficile trovare altrove linee così forti, angoli così precisi. Facile immaginarli in una casa o in un progetto. Perché questa collezione tocca la perfezione e la cristallizza nel gusto più attuale.

Design without compromise for bathroom sculpture. A collection which rose to the challenge of creating an interior with completely irregular shapes, and won hands down. Extremely high quality fabrication and finish are the secret. It's not easy to find such harsh lines, such precisely angled edges. It's easy, though, to foresee Frozen in a house or interior... because this collection just about approaches perfection, with a completely modern twist.

Design sans compromis pour des sculptures de salles de bain. Une collection qui gagne le défi : produire une ambiance aux formes complètement carrées, obtenues grâce à un travail d'une très haute rigueur. Il est difficile de trouver autre part des lignes aussi fortes, des angles aussi précis. Facile de les imaginer dans une maison ou dans un projet. Parce que cette collection touche la perfection et la cristallise dans le goût le plus actuel.

Eine Badezimmerkollektion in kompromißlosem Design und konstanter Materialqualität. Frozen kann ein Ambiente mit komplett eckigen Formen schaffen, die dank strengster Bearbeitungskriterien erfüllt werden. Kaum wird man eine andere so überzeugende Kollektionen finden, welche durch kräftige Linien und präzise Ecken besticht. Leicht ist diese Kollektion zu Hause oder in Ihren Entwürfen vorstellbar, denn sie ist greifbare Perfektion und bringt dies in moderner Sprache zum Ausdruck.

Бескомпромиссный дизайн для скульптуры ванной комнаты. Коллекция, бросающая вызов: создать окружение с квадратными формами, достигнутыми благодаря обработке высокой сложности. Трудно найти где-либо такие же сильные линии, такие же четкие углы. Легко представить их в доме или проекте. Поэтому данная коллекция затрагивает совершенство и кристаллизует его в настоящий вкус.

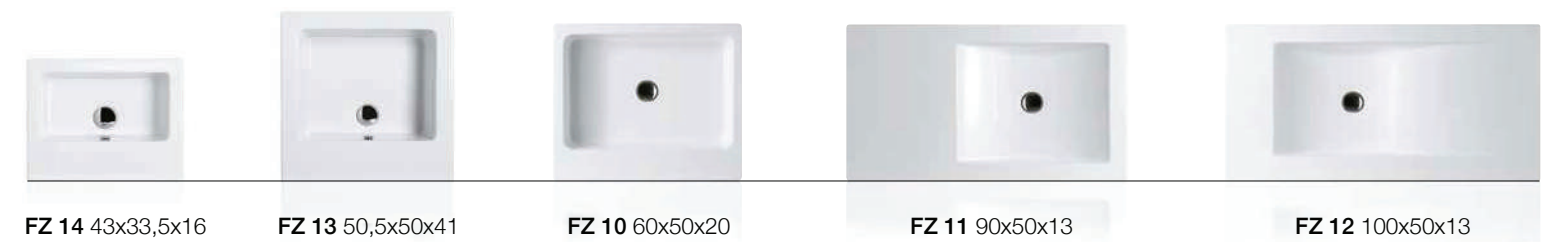

FZ 14 43x33,5x16

FZ 13 50,5x50x41

FZ 10 60x50x20

FZ 11 90x50x13

FZ 12 100x50x13



U 60 61x50,5x13

U 90 91x50,5x13

U 120 121x50,5x13

FZ 15 70x50,5x20

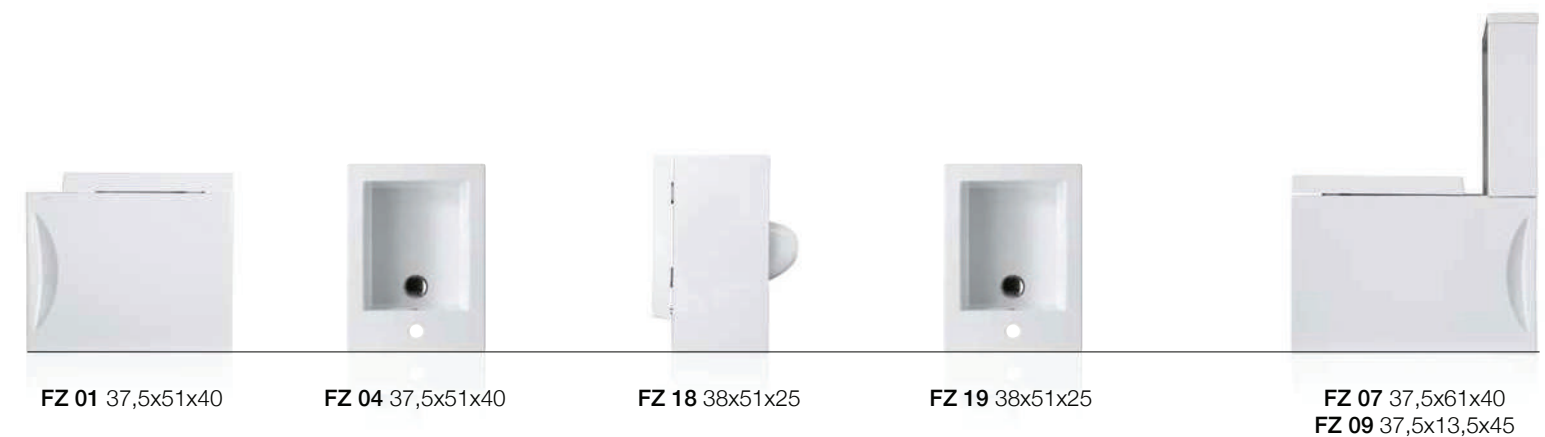

FZ 01 37,5x51x40

FZ 04 37,5x51x40

FZ 18 38x51x25

FZ 19 38x51x25

FZ 07 37,5x61x40  
FZ 09 37,5x13,5x45



# un gusto diverso nell'arredare lo spazio.

A different taste when decorating space.  
Un goût différent pour décorer les espaces.  
Ein neuer Einrichtungsgeschmack.  
Оформить пространство в новом стиле.

**> FZ 12**  
Console 100  
Console 100



**< FZ 01**  
Vaso carenato  
Back to wall WC

**<< FZ 04**  
Bidet carenato  
Back to wall bidet



**FZA 09**

Asta cromo per U 90  
 Chrome finish rail for U 90  
 Tige chromée pour U 90  
 Chromstange für U 90  
 полка FZA09 для U 90

**FZ/DUCG1**

Coppia montanti cromo  
 Set of chrome-finish legs  
 Couple montants chrome  
 Stützenpaar, Chrom  
 FZ/DUCG1 пара стоек хром

**U 90**

Lavabo 90 da appoggio  
 Counter top washbasin 90  
 Lavabo 90 d'appui  
 Waschbecken 90, als  
 Aufsatzwaschbecken  
 Раковина 90 опорный

**FZ 12**

Consolle 100 da appoggio  
 Counter top console 100  
 Console 100 d'appui  
 Konsole 100 stehend  
 Консоль 100 опорный

**FZ/DUCG1**

Coppia montanti cromo  
 Set of chrome-finish legs  
 Couple montants chrome  
 Stützenpaar, Chrom  
 FZ/DUCG1 пара стоек хром

**FZA 10**

Asta cromo per FZ 12  
 Chrome finish rail for FZ 12  
 Tige chromée pour FZ 12  
 Chromstange für FZ 12  
 полка FZA 09 для FZ 12

**U 60**

Lavabo 60 da appoggio  
 Counter top washbasin 60

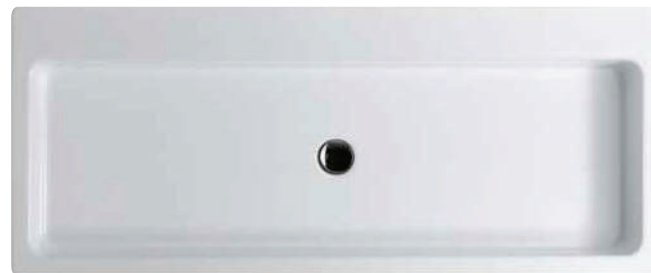
**U 120**

Lavabo 120 da appoggio  
 Counter top washbasin 120

ACCESSORI DI COMPLETAMENTO  
 ACCESSORIES AVAILABLE

**FZS 1** Specchio con cornice cromo  
 Mirror with chrome-finish metal frame  
**FZ/DUCG1** Coppia montanti cromo  
 Set of chrome-finish legs  
**FZA 06** Asta (U60)  
 Chrome-finish rail (U60)  
**FZA 12** Asta (U120)  
 Chrome-finish rail (U120)



ACCESSORI DI COMPLETAMENTO  
 ACCESSORIES AVAILABLE

**FZS 1** Specchio con cornice cromo  
 Mirror with chrome-finish metal frame  
**FZ/DUCG1** Coppia montanti cromo  
 Set of chrome-finish legs  
**FZA 10** Asta  
 Chrome-finish rail



**ACCESSORI DI COMPLETAMENTO**  
**ACCESSORIES AVAILABLE**

**FZS 1** Specchio con cornice cromo  
Mirror with chrome-finish metal frame

**FZ 13**

Lavabo 50 sospeso predisposto monoforo  
Wall hung washbasin 50 pre-punched for single tap hole  
Lavabo 50 suspendu prédisposé mono trou  
Waschbecken 50, wandhängend für Einlocharmatur  
Раковина подвесная с одним намеченным отверстием

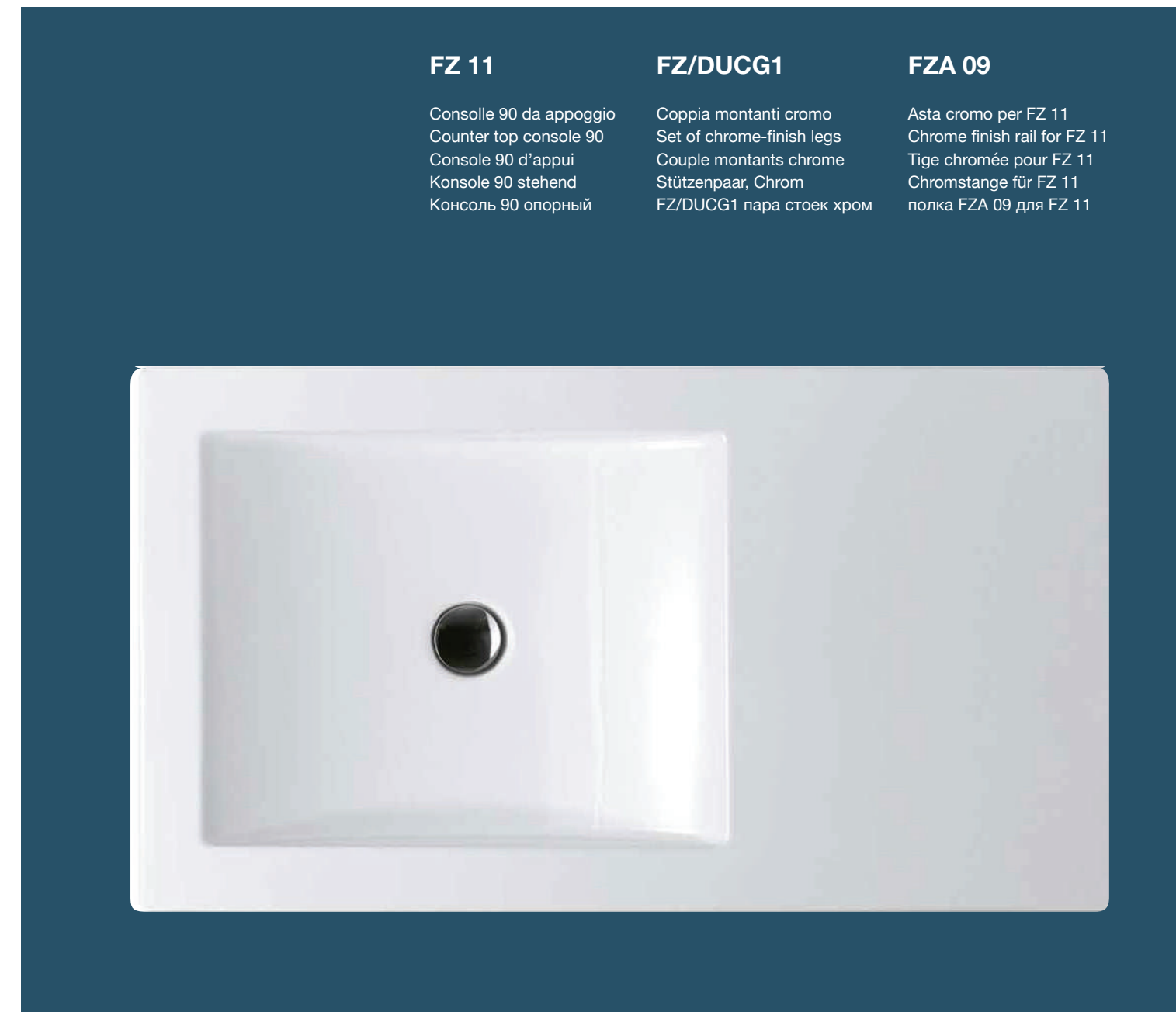

**FZ 11**

Consolle 90 da appoggio  
Counter top console 90  
Console 90 d'appui  
Konsole 90 stehend  
Консоль 90 опорный

**FZ/DUCG1**

Coppia montanti cromo  
Set of chrome-finish legs  
Couple montants chrome  
Stützenpaar, Chrom  
FZ/DUCG1 пара стоек хром

**FZA 09**

Asta cromo per FZ 11  
Chrome finish rail for FZ 11  
Tige chromée pour FZ 11  
Chromstange für FZ 11  
полка FZA 09 для FZ 11

**ACCESSORI DI COMPLETAMENTO**  
**ACCESSORIES AVAILABLE**

**FZS 1** Specchio con cornice cromo  
Mirror with chrome-finish metal frame  
**FZ/DUCG1** Coppia montanti cromo  
Set of chrome-finish legs  
**FZA 09** Asta  
Chrome-finish rail



**FZ 10**

Lavabo 60 da appoggio o sospeso predisposto monoforo  
 Counter top or wall hung washbasin 60 pre-punched for single tap hole  
 Lavabo 60 d'appui ou suspendu prédisposé mono trou  
 Waschbecken 60 als Aufsatzbecken oder wandhängend, für Einlocharmatur  
 Раковина 60 накладная или подвесная с одним намеченным отверстием



**ACCESSORI DI COMPLETAMENTO**  
**ACCESSORIES AVAILABLE**

**FZS 1** Specchio con cornice cromo  
 Mirror with chrome-finish metal frame  
**FZ/DUCG1** Coppia montanti cromo  
 Set of chrome-finish legs  
**FZA 06** Asta (U60)  
 Chrome-finish rail (U60)

**FZ 15**

Lavabo 70 semi-incasso  
 Semi-inset washbasin 70  
 Lavabo 70 semi emboîté  
 Halbeinbauwaschbecken 70  
 Раковина 70 полувстроенная



**FZ 14**

Lavamani 43  
 Hand washbasin 43  
 Lave mains 43  
 Handwaschbecken 43  
 Маленькая раковина 43

**FZ 04**

Bidet monoforo carenato  
 Back to wall bidet with single tap hole  
 Bidet mono trou caréné  
 Bidet, Einloch, verkleidet  
 Биде приставное с одним отверстием

**FZ 01**

Vaso carenato con scarico parete o pavimento  
 Back to wall WC with wall or floor outlet  
 Cuvette carénée décharge au mur ou au sol  
 WC, verkleidet. Wand- oder Bodenanschluss  
 Унитаз приставной. Горизонтальный или вертикальный слив



**ACCESSORI DI COMPLETAMENTO**  
**ACCESSORIES AVAILABLE**

**FZ 003** Coprivaso avvolgente in termoindurente con cerniere cromo  
 Wrap-around thermoset toilet seat with chrome-finish hinges  
**FZ 004** Coprivaso avvolgente in termoindurente con cerniere rallentate cromo  
 Wrap-around thermoset toilet seat with chrome-finish soft-closing hinges

**FZ 18**

Vaso sospeso. Completo di set di fissaggio F 85  
 Wall hung WC. Complete with fixing set F 85  
 Cuvette suspendue. Complet de set de fixation F 85  
 Hänge-WC. Inklusive Befestigungsset F 85  
 Унитаз подвесной вместе с крепежным комплектом F 85

**FZ 19**

Bidet sospeso monoforo. Completo di set di fissaggio F 85  
 Wall hung bidet with single tap hole. Complete with fixing set F 85  
 Bidet suspendu mono trou. Complet de set de fixation F 85  
 Hänge-Bidet, Einloch. Inklusive Befestigungsset F 85  
 Биде подвесное с одним отверстием. Комплектуется набором крепежей F 85

**ACCESSORI DI COMPLETAMENTO**  
**ACCESSORIES AVAILABLE**

**FZ 003** Coprivaso avvolgente in termoindurente con cerniere cromo  
 Wrap-around thermoset toilet seat with chrome-finish hinges  
**FZ 004** Coprivaso avvolgente in termoindurente con cerniere rallentate cromo  
 Wrap-around thermoset toilet seat with chrome-finish soft-closing hinges

**FZ 07**

Vaso monoblocco carenato con scarico a parete o pavimento  
 Back to wall close coupled WC with wall or floor outlet  
 Cuvette mono bloc carénée avec décharge au mur ou au sol  
 Monoblock-WC, verkleidet. Wand-oder Bodenanschluss  
 Унитаз моноблок. Горизонтальный или вертикальный слив.

**FZ 09**

Cassetta con coperchio per vaso monoblocco  
 Cistern with lid for close coupled WC  
 Caisse avec un couvercle pour cuvette monobloc  
 Monoblock-Spülkasten  
 Бачок с крышкой

**ACCESSORI DI COMPLETAMENTO**  
**ACCESSORIES AVAILABLE**

**FZ 003** Coprivaso avvolgente in termoindurente con cerniere cromo  
 Wrap-around thermoset toilet seat with chrome-finish hinges  
**FZ 004** Coprivaso avvolgente in termoindurente con cerniere rallentate cromo  
 Wrap-around thermoset toilet seat with chrome-finish soft-closing hinges  
**D 15** Batteria di scarico ad aria per cassetta monoblocco Frozen  
 Push button flush mechanism for close coupled cistern frozen  
**D 21** Batteria di scarico doppio flusso cassetta monoblocco  
 Push button double flush mechanism for close coupled cistern

**FZ 10**

kg 22

Lavabo 60 predisposto monoforo sospeso o da appoggio su struttura FZ/DUCG1-FZA 06 e su piano

Washbasin 60 pre-punched for single tap hole, wall hung or to be mounted on stand FZ/DUCG1-FZA 06 or on counter top

Lavabo 60 prédisposé mono trou suspendu ou d'appui sur structure FZ/DUCG1-FZA 06 et sur plan

Washbecken 60, für Einlocharmatur, wandhängend oder Montage auf Gestell FZ/DUCG1-FZA 06 und auf Ablage

Раковина 60 с одним намеченным отверстием подвесная или накладная, для установки на структуру FZ/DUCG1-FZA 06 и на столешницу

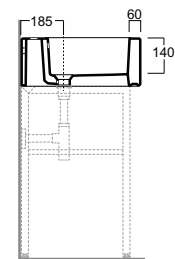
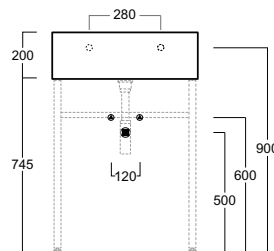
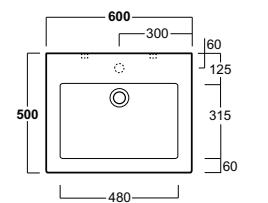
**FZ 13**

kg 32

Lavabo 50 sospeso predisposto monoforo

Wall hung washbasin 50 pre-punched for single tap hole

Lavabo 50 suspendu prédisposé mono trou

Washbecken 50, wandhängend für Einlocharmatur

Раковина подвесная с одним намеченным отверстием

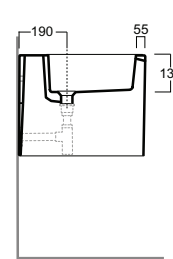
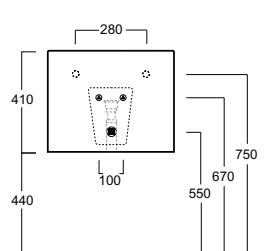
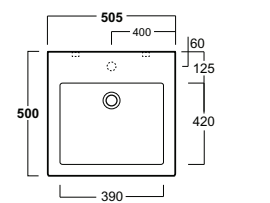
**U 60**

kg 18

Lavabo 60 predisposto per monoforo centrale da appoggio su struttura FZ/DUCG1-FZA 06 e su piano

Washbasin 60 pre-punched for central tap hole, to be mounted on stand FZ/DUCG1-FZA 06 or on counter top

Lavabo 60 prédisposé pour mono trou central d'appui sur structure FZ/DUCG1-FZA 06 et sur plan

Washbecken 60, für Einlocharmatur, Montage auf Gestell FZ/DUCG1-FZA 06 und auf Ablage

Раковина 60 с одним намеченным отверстием в центре, накладная для установки на структуру FZ/DUCG1-FZA 06 и на столешницу

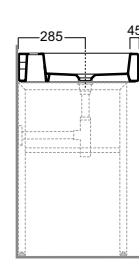
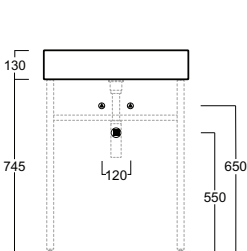
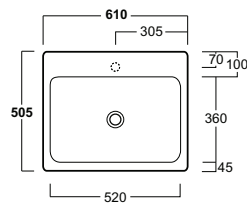
**U 90**

kg 26

Lavabo 90 predisposto per monoforo centrale, destro o sinistro da appoggio su struttura FZ/DUCG1-FZA 09 e su piano

Washbasin 90 pre-punched for central/right/left tap hole, to be mounted on stand FZ/DUCG1-FZA 09 or on counter top

Lavabo 90 prédisposée pour mono trou central, droite ou gauche d'appui sur structure FZ/DUCG1-FZA 09 et sur plan

Washbecken 90, für Einlocharmatur mittig, rechts oder links, Montage auf Gestell FZ/DUCG1-FZA 09 und auf Ablage

Раковина 90 с намеченными отверстиями по центру, справа и слева, накладная для установки на структуру FZ/DUCG1-FZA 09 и на столешницу

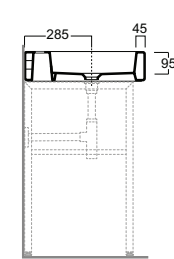
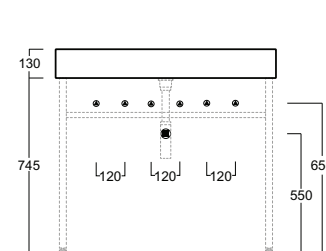
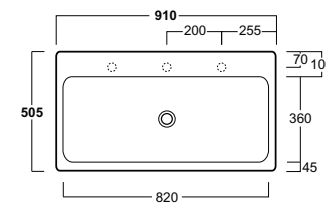
**U 120**

kg 34

Lavabo 120 predisposto per monoforo centrale, destro o sinistro da appoggio su struttura FZ/DUCG1-FZA 12 e su piano

Washbasin 120 pre-punched for central/right/left tap hole, to be mounted on stand FZ/DUCG1-FZA 12 or on counter top

Lavabo 120 prédisposé pour mono trou central, droite ou gauche d'appui sur structure FZ/DUCG1-FZA 12 et sur plan

Washbecken 120, für Einlocharmatur mittig, rechts oder links, Montage auf Gestell FZ/DUCG1-FZA 12 und auf Ablage

Раковина 120 с намеченными отверстиями по центру, справа и слева, накладная для установки на структуру FZ/DUCG1-FZA 12 и на столешницу

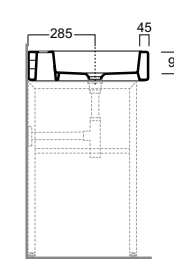
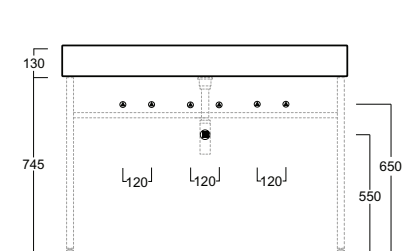
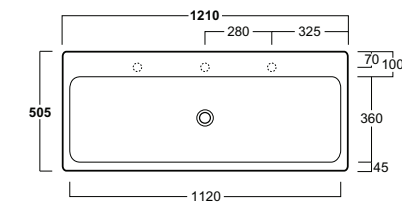
**FZ 11**

kg 25

Consolle 90 predisposta monoforo da appoggio su struttura FZ/DUCG1-FZA09 e su piano

Console 90 pre-punched for single tap hole, to be mounted on stand FZ/DUCG1-FZA09 or on counter top.

Console 90 prédisposée mono trou d'appui sur structure FZ/DUCG1-FZA09 et sur plan.

Konsole 90 für Einlocharmatur, Montage auf Gestell FZ/DUCG1-FZA09 und auf Ablage.

Консоль 90 с одним намеченным отверстием, накладная, для установки на структуру FZ/DUCG1-FZA09 и на столешницу

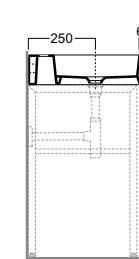
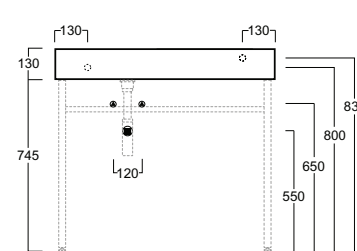
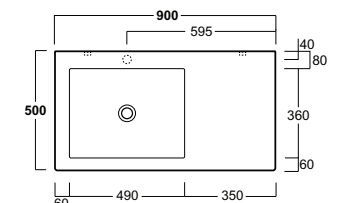

**FZ 12**

kg 26

Consolle 100 predisposta monoforo da appoggio su struttura FZ/DUCG1-FZA 10 e su piano

Console 100 pre-punched for single tap hole, to be mounted on stand FZ/DUCG1-FZA 10 or on counter top

Console 100 prédisposée mono trou d'appui sur structure FZ/DUCG1-FZA 10 et sur plan

Konsole 100 für Einlocharmatur, Montage auf Gestell FZ/DUCG1-FZA 10 und auf Ablage

Консоль 100 с одним намеченным отверстием накладная, для установки на структуре FZ/DUCG1-FZA 10 и на столешницу

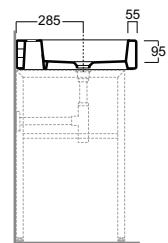
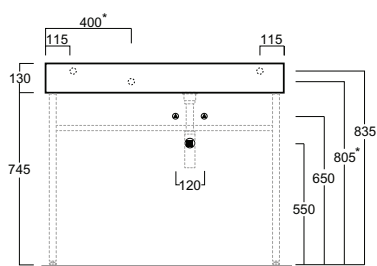
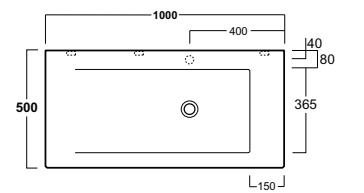
**FZ 14**

kg 11

Lavamani 43 predisposto monoforo

Hand washbasin 43 pre-punched for single tap hole

Lave mains 43 prédisposé mono trou

Handwaschbecken 43 für Einlocharmatur

Маленькая раковина 43 с одним намеченным отверстием

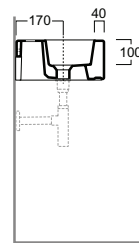
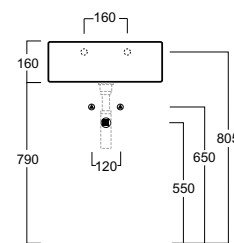
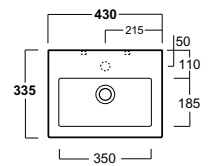
**FZ 15**

kg 26

Lavabo 70 semi-incasso predisposto monoforo

Semi-inset washbasin 70 pre-punched for single tap hole

Lavabo 70 semi emboîté prédisposé mono trou

Halbeinbauwaschbecken 70, für Einlocharmatur

Раковина 70 полувстроенная с одним намеченным отверстием

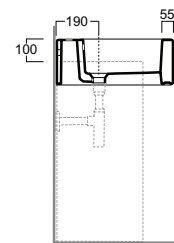
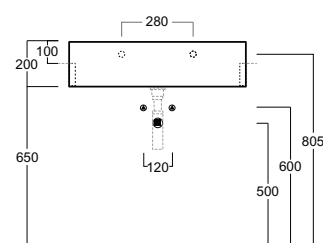
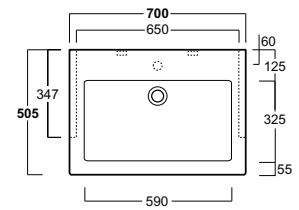
**FZ 04**

kg 27

Bidet monoforo carenato

Back to wall bidet with single tap hole

Bidet mono trou caréné

Bidet, Einloch, verkleidet

Биде приставное с одним отверстием

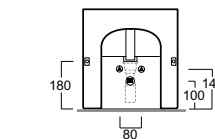
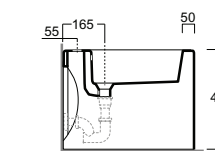
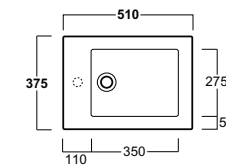
**FZ 01**

kg 29

Vaso carenato con scarico parete o pavimento (curva tecnica inclusa)

Back to wall WC with wall or floor outlet (curved pipe included)

Cuvette carénée décharge au mur ou au sol (courbe technique incluse)

WC, verkleidet. Wand- oder Bodenanschluss (Inklusive Bogenrohr)

Унитаз приставной. Горизонтальный или вертикальный слив (техническое колено включено в комплектацию)

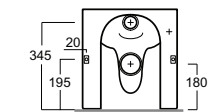
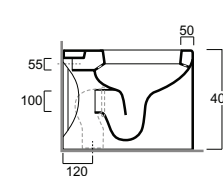
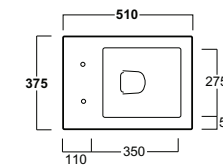
**FZ 19 / F 85**

kg 27

Bidet sospeso monoforo. Completo di set di fissaggio F 85

Wall hung bidet with single tap hole. Complete with fixing set F 85

Bidet suspendu mono trou complet de set de fixation F 85

Hänge-Bidet, Einloch. Inklusive Befestigungsset F 85

Биде подвесное с одним отверстием. Комплектуется набором крепежей F 85

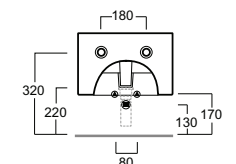
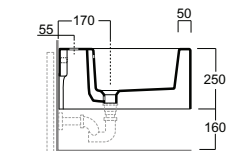
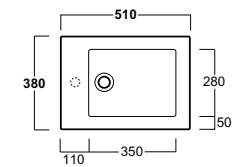



**FZ 18 / F 85**

22 kg

Vaso sospeso.  
Completo di set di fissaggio F 85

Wall hung WC.  
Complete with fixing set F 85

Cuvette suspendue.  
Complet de set de fixation F 85

Hänge-WC.  
Inklusive Befestigungsset F 85

Унитаз подвесной.  
Комплектуется набором крепежей F 85

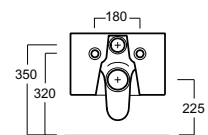
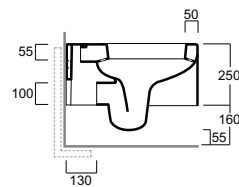
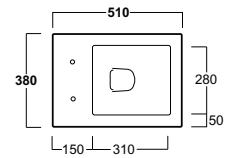
**FZ 07**

kg 33

Vaso monoblocco carenato con scarico a parete o pavimento (curva tecnica inclusa)

Back to wall close coupled WC with wall or floor outlet (curved pipe included)

Cuvette mono bloc carénée avec décharge au mur ou au sol (courbe technique incluse)

Monoblock-WC, verkleidet. Wand- oder Bodenanschluss (Inklusive Bogenrohr)

Унитаз моноблок. Горизонтальный или вертикальный слив (техническое колено включено в комплектацию)

**FZ 09**

15 kg

Cassetta con coperchio per vaso monoblocco  
Cistern with lid for close coupled WC  
Réservoir avec couvercle pour cuvette mono bloc  
Monoblock-Spülkasten  
Бачок с крышкой FZ09

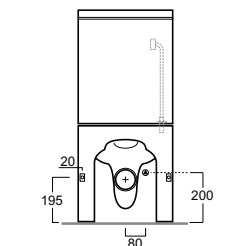
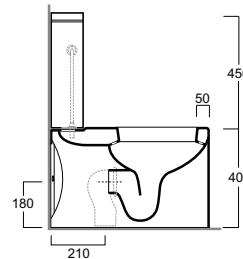
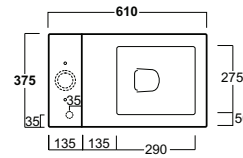
**FZ 003**

kg 2,8

Coprivaso avvolgente in termoindurente cerniere cromo

Wrap-around thermoset toilet seat with chrome-finish hinges

Abattant en thermo durcisseur charnières chrome

WC Deckel, thermoverformt, Chromscharniere

Сиденье из терморезины, хром, с микролифтом

**FZ 004**

kg 2,8

Coprivaso avvolgente in termoindurente con cerniere rallentate cromo

Wrap-around thermoset toilet seat with chrome-finish soft-closing hinges

Abattant enveloppant en thermo durcisseur avec des charnières ralenties chrom

WC Deckel, thermoverformt, Chromscharniere mit Absenkautomatik

Сиденье из терморезины, шарниры хром

**FZS 1**

kg 8,5

Specchio con cornice cromo

Mirror with chrome-finish metal frame

Miroir avec cadre chrome

Spiegel mit Chrommetallahmen

Зеркало с рамкой хром. С декором Reinassance или без него

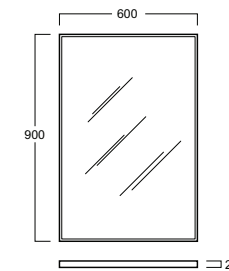
**FZ/DUCG1**

kg 6

Coppia montanti cromo per lavabo/console  
FZ 10 - U 60 / FZ 11 - U 90 - FZ 12 - U 120

Set of chrome-finish legs for washbasin/console  
FZ 10 - U 60 / FZ 11 - U 90 - FZ 12 - U 120

Couple montants chrome pour lavabo/console  
FZ 10 - U 60 / FZ 11 - U 90 - FZ 12 - U 120

Stützenpaar, Chrom für Waschbecken/Konsolen  
FZ 10 - U 60 / FZ 11 - U 90 - FZ 12 - U 120

FZ/DUCG1 пара стоек хром для раковины/консоли FZ 10 - U 60 / FZ 11 - U 90 - FZ 12 - U 120

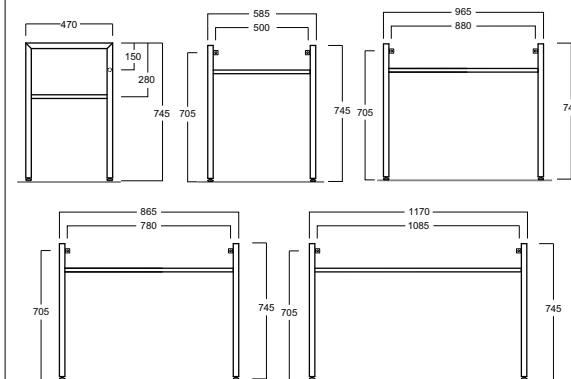
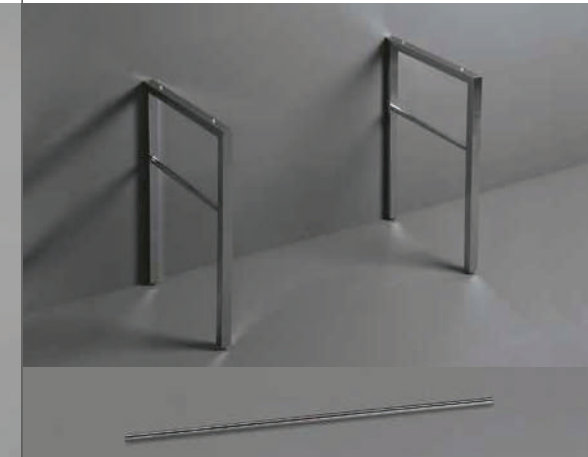
**FZA**

Asta cromo per lavabo/console.  
Chrome-finish rail for washbasin/console.  
Tige chromée pour lavabo/console.  
Chromstange für Waschbecken/Konsolen.  
полка для раковины/консоли.

Art.	cm.	kg	per/for/pour/ für/ для
FZA 06	52,2	0,4	FZ 10 - U 60
FZA 09	80,6	0,6	FZ 11 - U 90
FZA 10	90,6	0,6	FZ 12
FZA 12	111,5	0,7	U 120

**F 89**

kg 0,18

Set viti di fissaggio per lavabo

Set fixing screws for washbasin

Set de vis de fixation pour lavabo

Montageset Waschbecken

Комплект крепежных винтов для раковины

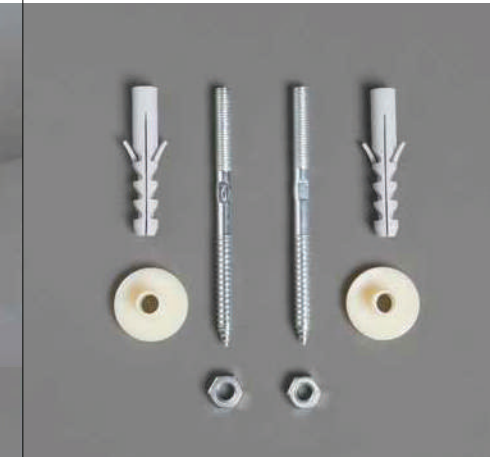
**F 90**

kg 0,02

Set viti di fissaggio verticali cromo/bianco per vaso o bidet

Set of chrome/white vertical fixing screws for wc or bidet

Set de vis de fixation verticales chromé/blanc pour WC ou bidet

Montageset senkrecht weiss/chrom für WC oder Bidet

Комплект вертикальных крепежных винтов белый/хром для унитаза или биде

**F 84**

kg 3

Coppia staffe di fissaggio per vaso o bidet sospesi

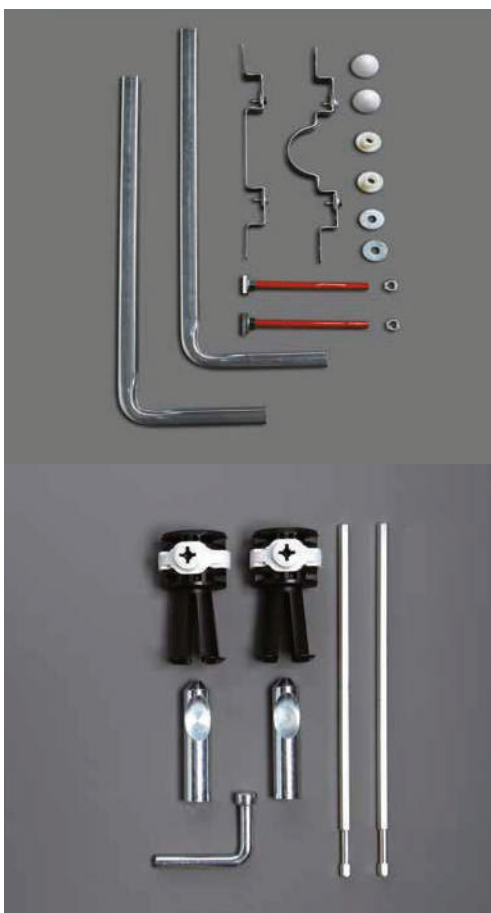
*A pair of brackets for wall hung wc or bidet**Paire d'équerres de fixation pour cuvette ou bidet suspendus**Paar Befestigungshalterungen für Wandklosett oder Wandbidets**Пара крепёжных скоб для подвесных унитаза или биде***F 85**

kg 0,3

Set viti fissaggio a completamento staffe F 84 per vaso o bidet sospesi

*Fixing Kit for F 84 brackets for wall hung WC or bidet**Jeu de vis de fixation pour équerre F 84 pour cuvette ou bidet suspendu**Satz Befestigungsschrauben zur Ergänzung der Halterungen F 84 Wandklosett oder Wandbidet**Комплект крепёжных винтов для комплектования скоб F 84 для подвесного унитаза или биде***D 15**

kg 1

Batteria di scarico ad aria con pulsante cromo per cassetta monoblocco Frozen

*Push button flush mechanism in chrome-finish for close coupled cistern Frozen.**Batterie de vidage à air avec bouton chromé pour réservoir monobloc Frozen**Druckluft-Spülung mit WC-Taste in Chrom für Komplettspülung Frozen**Пневматический механизм слива с хромированной кнопкой для моноблочного бачка Frozen***D 21**

kg 1

Batteria di scarico doppio flusso cromo per cassetta monoblocco

*Push button double flush mechanism in chrome-finish for close coupled cistern**Mécanisme de chasse, double chasse, avec bouton chromé pour réservoir monobloc**Spülung, 2-Mengen-Spülung mit WC-Taste in Chrom für Komplett-Spülkasten**Механизм слива с двойным потоком хромированный для моноблочного бачка***SIF 165**

kg 1,1

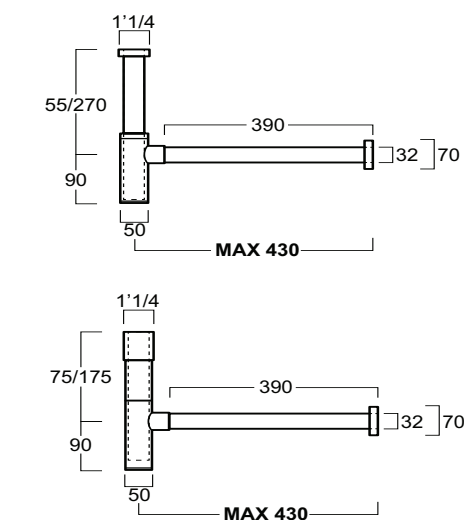
Sifone cilindrico lavabo da 1<sup>1/4</sup>"*Cylindrical trap for washbasin 1<sup>1/4</sup>"**Siphon cylindrique pour lavabo de 1<sup>1/4</sup>"**Siphon, zylindrisch für Waschbecken 1<sup>1/4</sup>"**Сифон цилиндрической формы для раковин***SIF 270**

kg 1,4

Sifone cilindrico lavabo da 1<sup>1/4</sup>"*Cylindrical trap for washbasin 1<sup>1/4</sup>"**Siphon cylindrique pour lavabo de 1<sup>1/4</sup>"**Siphon, zylindrisch für Waschbecken 1<sup>1/4</sup>"**Сифон цилиндрической формы для раковин***SIF 125**

kg 1

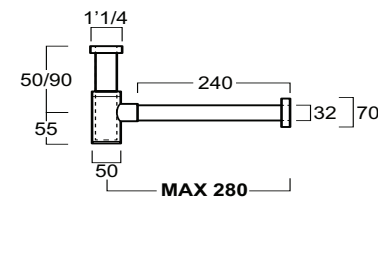
Sifone cilindrico per bidet da 1<sup>1/4</sup>"*Cylindrical trap for bidet 1<sup>1/4</sup>"**Siphon cylindrique pour bidet de 1<sup>1/4</sup>"**Siphon, zylindrisch für Bidet 1<sup>1/4</sup>"**Цилиндрический сифон для биде 1<sup>1/4</sup>"***PLCR**

kg 0,4

Piletta "shut rapid" o "free flow" cromo

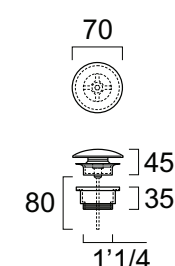
*Pop-up waste "shut rapid" or "free flow" chrome**Bonde "shut rapid" ou "free flow" chromée**Abflusstöpsel "Shut rapid" oder "free flow" chrom**Донный клапан типа "быстрый затвор" или "свободный поток" хром.***PLCE**

kg 0,5

Piletta "shut rapid" o "free flow" in ceramica\*

*Pop-up waste "shut rapid" or "free flow" ceramic**Bonde "shut rapid" ou "free flow" céramique**Abflusstöpsel "Shut rapid" oder "free flow" keramik**Донный клапан типа "быстрый затвор" или "свободный поток" керамика.*

\* Disponibile in tutti i colori  
 Available in all colors  
 Disponible dans tous les coloris  
 Verfüegbar in alle die Farben  
 В наличии все цвета

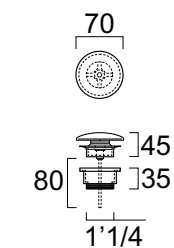

# sharp

DESIGN: UFFICIO TECNICO

Quando la geometria si diverte con il colore. Cerchio, quadrato, ovale, rettangolo per la collezione di lavabi d'appoggio d'arredo SHARP dal design essenziale, sempre stondatissimo. Con una lavorazione di alta tecnologia produttiva del vitreo china che rende il bordo millimetrico. Una collezione intelligente anche nella versione con piano rubinetteria che amplia gli spazi fruibili. Undici varianti di colore, da quelli più delicati, che soddisfano il desiderio di fluidità e rassicurazione, ai più decisi, dalle nuance calde, per appagare la voglia di naturalità. Per qualsiasi ambiente, dal piccolo al grande, dal privato al pubblico. Per dare un guizzo di vivacità alla 'stanza dell'acqua', ma anche alla parete di una camera da letto o al corner di un ambiente living.

When geometry plays with colors. Circle, square, oval, rectangle for the collection of vanity sit-on basins SHARP characterized by the essential design and very rounded shapes. With a high-tech process of vitreous-china to have a millimeter thick edge. A smart collection that in the version with tap holes broadens the spaces available. Eleven different colors, from the most delicate that satisfy the desire for fluidity and relax, up to warm colors and strong, warm hues to satisfy user's craving for genuineness. For any space from small to large, from private to public. To give a flicker of vitality not only to the 'water room' but also to the wall of a bedroom as well as in the corner of a living room.

Quand la géométrie s'amuse avec la couleur. Cercle, carré, ovale, rectangle pour la collection de vasque à poser SHARP, au design essentiel, toujours super arrondi. Une élaboration d'haute technologie de la porcelaine au rebord millimétrique. Une collection ingénieuse aussi dans la version avec planche pour la robinetterie, qui augmente l'espace disponible. Onze couleurs des plus délicats, qui répondent à la demande de fluidité et rassurement aux plus décisifs avec nuances chaudes pour satisfaire l'envie de naturalité. Pour tous les ambiances, du petit au plus grand, du privé au public. Pour donner un sursaut de vivacité à la 'salle de l'eau', mais aussi bien à la paroi d'une chambre à coucher ou au 'corner' d'un 'living'.

Wenn die Geometrie mit Farben spielt. Runde, Quadrat, Ovale, Rechteck für die Kollektion von Aufsatzbecken SHARP mit einem minimalistischen und Superunden Design. Ein Werk hoher Produktionstechnologie des Porzellans, das den Rand millimeter-Groß macht. Eine kluge Kollektion auch in den Modellen mit Einlocharmatur, die mehr nützlichen Raum garantieren. Elf verschiedene Farben von den delikatesten, die den Wunsch zu Fluidität und Beruhigung erfüllen, bis zu den intensivsten, die Wärme und Naturalität bieten. Für alle Räume, von kleinen zu größeren, von privaten zu öffentlichen. Um eines Flackern von Lebendigkeit des 'Raums des Wassers' zu geben, sowie der Wand einer Schlafzimmer oder des 'Corners' eines 'Livings'.

Когда геометрическая форма играет с цветом. Круг, квадрат, овал, прямоугольник - формы коллекции накладных раковин SHARP - всегда актуальны. С помощью высокотехнологичной обработки санфарфора края раковины становятся миллиметровыми. Умная коллекция, также и в варианте с поверхностью под смеситель, расширяющая возможности использования рабочего пространства. Одиннадцать оттенков, от самых нежных пастельных, до ярких и сочных натуральных цветов. Для любых помещений, больших и маленьких, как общественных, так и частных. Привносит жизнерадостность в "пространство воды" ванной комнаты, а также возможно спальни или любого другого жилого помещения.

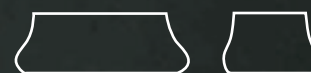

SH 01 50x50x14,5



SH 02 42x42x16



SH 03 42x42x16



SH 04 60x42x16



SH 05 60x42x16



SH 06 42x42x16



SH 07 42x42x16



SH 08 60x42x16



SH 09 60x42x16



SH 10 42x42x44

# COLORS



BIANCO MATT



NERO MATT



CEMENTO MATT



TELA MATT



ANTRACITE MATT



MOKA MATT



SABBIA MATT



PERVINCA MATT



NAVY MATT



PRUGNA MATT



MIRTO MATT



BIANCO



NERO



CHAMPAGNE



## SH 10

Lavabo tondo Sharp 42 da appoggio - h44  
 Sharp round counter top washbasin 42 - h44 cm  
 Vasque à poser ronde Sharp 42 - h44 cm  
 Rundes Aufsatzbecken Sharp 42 - h44 cm  
 Круглая высокая накладная раковина

**SH 01**

Lavabo tondo Sharp 50 da appoggio  
 Round counter top washbasin Sharp 50 cm  
 Vasque à poser ronde Sharp 50 cm  
 Rundes Aufsatzbecken Sharp 50 cm  
 Круглая накладная раковина

**SH 02**

Lavabo tondo Sharp 42 da appoggio  
 Round counter top washbasin Sharp 42 cm  
 Vasque à poser ronde Sharp 42 cm  
 Rundes Aufsatzbecken Sharp 42 cm  
 Круглая накладная раковина

**SH 03**

Lavabo tondo Sharp 42 d'appoggio monoforo  
 Round counter top washbasin Sharp 42 cm with tap hole  
 Vasque à poser ronde mono trou Sharp 42 cm  
 Rundes Aufsatzbecken mit Einlocharmatur Sharp 42 cm  
 Круглая накладная раковина с одним отверстием



**SH 04**

Lavabo ovale Sharp 60 da appoggio  
 Oval counter top washbasin Sharp 60 cm  
 Vasque à poser ovale Sharp 60 cm  
 Eirundes Aufsatzbecke Sharp 60 cm  
 Овальная накладная раковина

**SH 05**

Lavabo ovale d'appoggio Sharp 60 monoforo  
 Oval counter top washbasin with tap hole Sharp 60 cm  
 Vasque à poser ovale mono trou Sharp 60 cm  
 Eirundes Aufsatzbecken mit Einlocharmatur Sharp 60 cm  
 Овальная накладная раковина с одним отверстием



**SH 06**

Lavabo quadrato da appoggio Sharp 42  
 Square counter top washbasin Sharp 42 cm  
 Vasque à poser carrée Sharp 42 cm  
 Quadrates Aufsatzbecken Sharp 42 cm  
 Квадратная накладная раковина

**SH 07**

Lavabo quadrato d'appoggio monoforo Sharp 42  
 Square counter top washbasin with tap hole Sharp 42 cm  
 Vasque à poser carrée mono trou Sharp 42 cm  
 Quadrates Aufsatzbecken mit Einlocharmatur Sharp 42 cm  
 Квадратная накладная раковина с одним отверстием 42 см



**SH 08**

Lavabo rettangolare Sharp 60 da appoggio  
 Rectangular counter top washbasin Sharp 60 cm  
 Vasque à poser rectangulaire Sharp 60 cm  
 Rechteckiges Aufsatzbecken Sharp 60 cm  
 Прямоугольная накладная раковина 60 см

**SH 09**

Lavabo rettangolare d'appoggio Sharp 60 monoforo  
 Rectangular counter top washbasin with tap hole Sharp 60 cm  
 Vasque à poser rectangulaire mono trou Sharp 60 cm  
 Rechteckiges Aufsatzbecken mit Einlocharmatur Sharp 60 cm  
 Прямоугольная накладная раковина с одним отверстием 60 см





**SH 01**

kg 9,5

Lavabo tondo da appoggio

*Round counter top washbasin**Vasque à poser ronde**Rundes Aufsatzbecken**Круглая накладная раковина***SH 02**

kg 8

Lavabo tondo da appoggio

*Round counter top washbasin**Vasque à poser ronde**Rundes Aufsatzbecken**Круглая накладная раковина***SH 03**

kg 9

Lavabo tondo d'appoggio monoforo

*Round counter top washbasin with tap hole**Vasque à poser ronde mono trou**Rundes Aufsatzbecken mit Einlocharmatur**Круглая накладная раковина с одним отверстием***SH 04**

kg 11,5

Lavabo ovale da appoggio

*Oval counter top washbasin**Vasque à poser ovale**Eirundes Aufsatzbecken**Овальная накладная раковина***SH 05**

kg 12,5

Lavabo ovale d'appoggio monoforo

*Oval counter top washbasin with tap hole**Vasque à poser ovale mono trou**Eirundes Aufsatzbecken mit Einlocharmatur**Овальная накладная раковина***SH 06**

kg 10

Lavabo quadrato d'appoggio monoforo

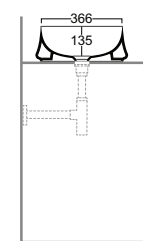
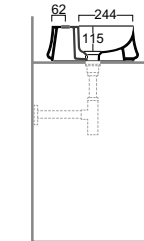
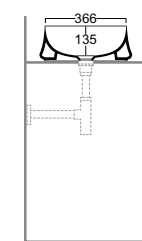
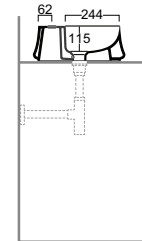
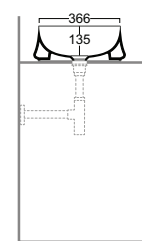
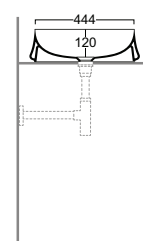
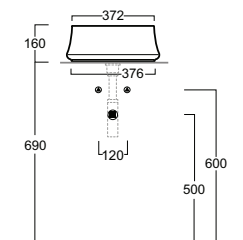
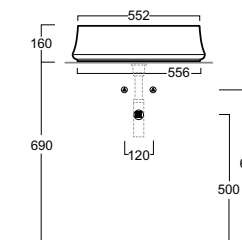
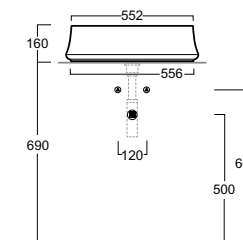
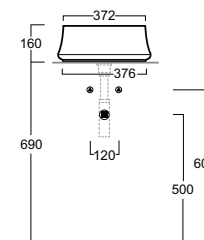
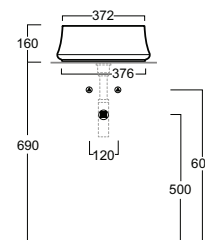
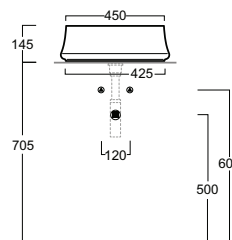
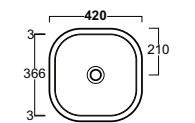
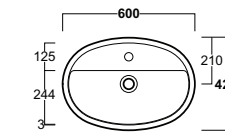
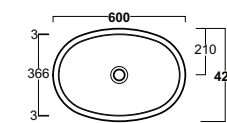
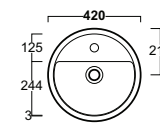
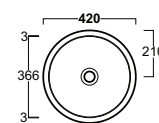
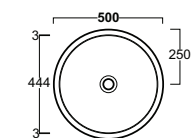
*Square counter top washbasin with tap hole**Vasque à poser carrée mono trou**Quadrates Aufsatzbecken mit Einlocharmatur**Квадратная накладная раковина*

**SH 07**

kg 11

Lavabo quadrato d'appoggio monoforo

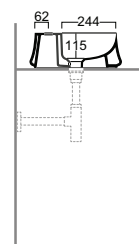
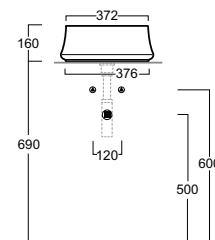
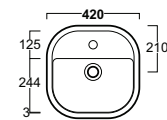
*Square counter top washbasin with tap hole**Vasque à poser carrée mono trou**Quadrates Aufsatzbecken mit Einlocharmatur**Квадратная накладная раковина***SH 08**

kg 13

Lavabo rettangolare da appoggio

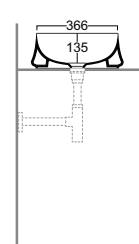
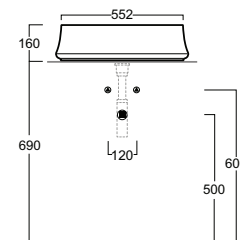
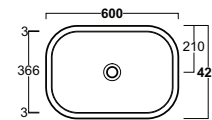
*Rectangular counter top washbasin**Vasque à poser rectangulaire**Rechteckiges Aufsatzbecken**Прямоугольная накладная раковина***SH 09**

kg 15

Lavabo rettangolare d'appoggio monoforo

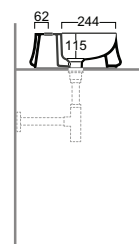
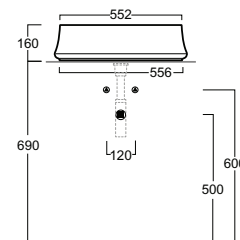
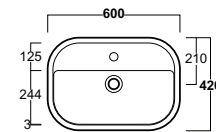
*Rectangular counter top washbasin with tap hole**Vasque à poser rectangulaire mono trou**Rechteckiges Aufsatzbecken mit Einlocharmatur**Прямоугольная накладная раковина***SH 10**

kg 15

Lavabo tondo Sharp 42 da appoggio - h44

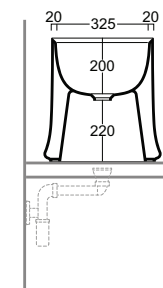
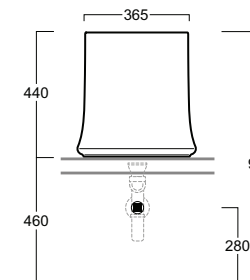
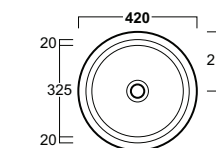
*Sharp round counter top washbasin 42 - h44 cm**Vasque à poser ronde Sharp 42 - h44 cm**Rundes Aufsatzbecken Sharp 42 - h44 cm**Круглая высокая накладная раковина 42 - h44 см***PLCR**

kg 0,4

Piletta "shut rapid" o "free flow" cromo

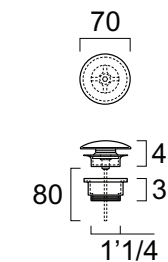
*Pop-up waste "shut rapid" or "free flow" chrome**Bonde "shut rapid" ou "free flow" chromée**Abflusstöpsel "Shut rapid" oder "free flow" chrom**Донный клапан типа "быстрый затвор" или "свободный поток" хром***PLCE**

kg 0,5

Piletta "shut rapid" o "free flow" in ceramica

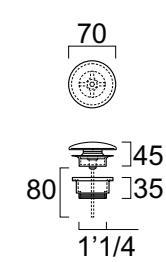
*Pop-up waste "shut rapid" or "free flow" ceramic**Bonde "shut rapid" ou "free flow" céramique**Abflusstöpsel "Shut rapid" oder "free flow" keramik**Донный клапан типа "быстрый затвор" или "свободный поток" керамика*

\* Disponibile in tutti i colori  
 Available in all colors  
 Disponible dans tous les coloris  
 Verfüegbar in alle die Farben  
 В наличии все цвета

# frame

DESIGN: UFFICIO TECNICO

Semplice, minimalista quanto basta, strizza l'occhio allo stile 'urban industrial' senza rinunciare alla praticità. Questo il concetto progettuale della collezione di mobili FRAME nata per accompagnare i lavabi d'appoggio SHARP e studiata per una polifunzionalità allargata come detta il bagno di nuova generazione. Due le versioni, mobile singolo e mobile doppio, con sifone a scomparsa per guadagnare spazio, barra laterale che funge da porta asciugamani, elemento a giorno volutamente più basso rispetto al cassetto per un'ulteriore superficie di appoggio.

Simple sufficiently minimalist it approaches the "urban industrial" style without sacrificing convenience. This is the concept of the furniture collection FRAME, created to accompany the countertop washbasins SHARP and designed for widened multifunctionality, as the new bathroom demands. Two versions, single and double cabinet, with space-saving siphon, sidebar that serves as a towel rack, open cabinet deliberately lower than the drawer to make another top available.

Quand le fonctionnel revête le cadre. Simple, minimaliste juste ce qu'il faut, c'est un clin d'oeil au «style 'industriel urbain» sans sacrifier le côté pratique. Voici le concept à l'origine de la collection de meubles FRAME.

Wenn die Zweckdienlichkeit das Rahmen kleidet. Einfach, genügend minimalistisch mit einem Zwinkern zum 'urban industrial' Style, ohne den Komfort aufzugeben. Dies ist das Konzept, das an der Base des Projektes der Möbeln FRAME steht.

Простой и минималистичный дизайн, так называемый "городской индустриальный" стиль, но обязательно практичный. Вот концепция коллекции мебели FRAME, созданная в дополнение к коллекции накладных раковин SHARP. Эта мебель отличается многофункциональностью, что характерно для ванной комнаты нового поколения. Два варианта - одинарная композиция и двойная, со скрытым сифоном для экономии места, с боковой вешалкой под полотенца, с открытой полкой, расположенной ниже относительно ящика, что создает дополнительную полезную поверхность.



FM 1 105x57x79



FM 2 181x57x79



FS 1 80x70



FS 2 70x70



FS 3

**> FS 3**  
Lampada per specchio FS 2  
Lamp for mirror FS 2

**> FS 2**  
Specchio 70 tondo  
Round mirror cm 70

## La struttura minimale dal carattere geometrico.

The minimal structure of the geometric fitting.  
Reconfiguration géométrique pour l'extrême recherche de la finesse.  
Geometrische Neugestaltung für die Suche nach extrem schmalen, dünnen Elementen.  
Пересмотр геометрического образа как поиск предельной утонченности.

**< SH 02**  
Lavabo tondo d'appoggio cm 42  
Sharp round counter top wash basin cm 42

**> FM 2**  
Mobile 181 con cassetti. Rovere Scuro  
Cabinet cm 181 with drawers. Dark Oak



**FM 2**

Mobile cm 181 con cassetti. Rovere Scuro.  
 Cabinet cm 181 with drawers. Dark Oak finish.  
 Mobile 181 cm avec tiroirs. Couleur chêne foncé.  
 Unterbau 181 cm mit Schubladen. Dunkle Eiche.  
 181 см шкаф с ящиками. Темный дуб.

**FS 2 / FS 3**

Specchio tondo cm 70 e lampada magnetica.  
 Round mirror cm 70 and magnetic lamp.  
 Miroir rond cm 70 et lampe magnétique.  
 Rundspiegel cm 70 und magnetische Lampe.  
 Круглое зеркало cm 70 Лампа и магнит.



**FS 1**

Specchio retroilluminato cm 70x80.  
 Lighted vanity mirror cm 70x80.  
 Miroir rétroéclairé cm 70x80.  
 Spiegel mit LED Beleuchtung cm 70x80.  
 Зеркало с задней подсветкой cm 70x80.

**FM 1**

Mobile cm 105 con cassetto. Rovere Scuro.  
 Cabinet cm 105 with drawer. Dark Oak finish.  
 Mobile 105 cm avec tiroirs. Couleur chêne foncé.  
 Unterbau 105 cm mit Schubladen. Dunkle Eiche.  
 105 см шкаф с ящиками. Темный дуб.

**FS 2 / FS 3**

Specchio tondo cm 70 e lampada magnetica.  
 Round mirror cm 70 and magnetic lamp.  
 Miroir rond cm 70 et lampe magnétique.  
 Rundspiegel cm 70 und magnetische Lampe.  
 Круглое зеркало cm 70 Лампа и магнит

**FM 2**

Mobile cm 181 con cassetti.  
 Frassino grigio e Bianco Opaco.  
 Cabinet cm 181 with drawers.  
 Grey Ashwood and Matte White finish.  
 Mobile 181 cm avec tiroirs.  
 Gris Ash et blanc mat.  
 Unterbau 181 cm mit Schubladen.  
 Ash grau und weiß matt.  
 181 cm шкаф с ящиками.  
 Пепел и матовый белый.







**FM 1**

kg 55

Struttura in metallo con cassetto premi-apri ed elemento a giorno. Sifone salva-spazio e kit di montaggio inclusi. Finitura 1 e Finitura 2

*Metal frame with push-to-open drawer, top and open cabinet. Space-saving siphon and fixing kit included. Finish 1 and Finish 2.*

*Structure en métal avec tiroir „pousser pour ouvrir“ et élément à jour. Siphon gagne place et kit de montage inclus. Finition 1 and finition 2.*

*Metallstruktur mit einem Drücke zum Öffnen Auszug und offenem Schrank. Platzsparender Siphon und Befestigungsset inklusive. Finish 1 and Finish 2.*

*Металлическая структура с ящиком с механизмом открывания push pull и с открытым элементом. Сифон и монтажный набор включены. Темный дуб. чистовая обработка 1 и чистовая обработка 2.*

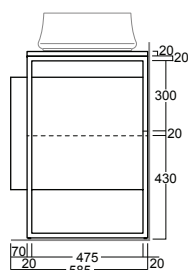
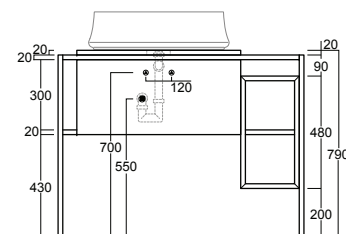
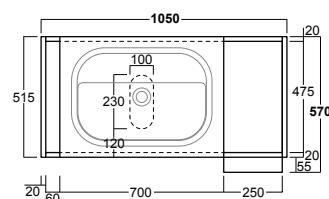
**FM 2**

kg 90

Struttura in metallo con cassetto premi-apri ed elemento a giorno. Sifone salva-spazio e kit di montaggio inclusi. Finitura 1 e Finitura 2

*Metal frame with push-to-open drawer, top and open cabinet. Space-saving siphon and fixing kit included. Finish 1 and Finish 2.*

*Structure en métal avec tiroir „pousser pour ouvrir“ et élément à jour. Siphon gagne place et kit de montage inclus. Finition 1 and finition 2.*

*Metallstruktur mit einem Drücke zum Öffnen Auszug und offenem Schrank. Platzsparender Siphon und Befestigungsset inklusive. Finish 1 and Finish 2.*

*Металлическая структура с ящиком с механизмом открывания push pull и с открытым элементом. Сифон и монтажный набор включены. Темный дуб. чистовая обработка 1 и чистовая обработка 2.*

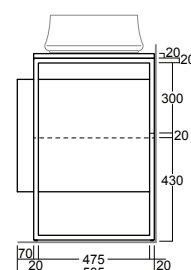
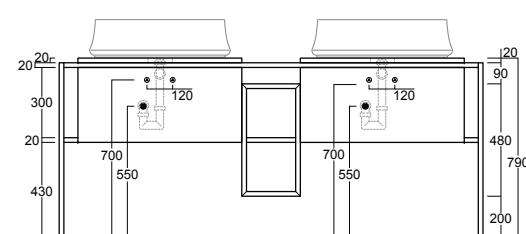
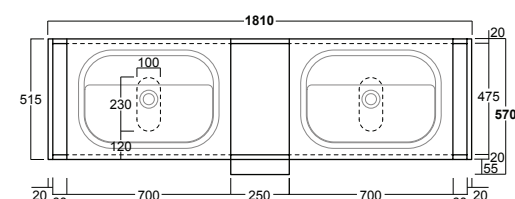
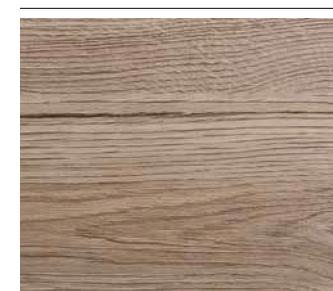
**FINITURE DISPONIBILI**

Finitura 1 - Rovere Scuro  
Finish 1 - Dark Oak

Finitura 1: Cassetto, top ed elemento a giorno Rovere Scuro.

*Finish 1: Drawer, top and open cabinet in Dark Oak color.*

*Finition 1: Tiroir, dessus et armoire ouverte. En couleur Dark Oak.*

*Finish 1: Schublade, oben und offener Schrank in dunkler Eiche Farbe.*

*чистовая обработка 1: Выдвижной ящик, верхний и открытый шкаф в цвете темный дуб.*

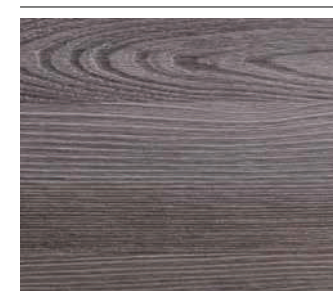

Finitura 2 - Frassino Grigio  
Finish 2 - Grey Ashwood

Finitura 2 - Bianco Opaco  
Finish 2 - Matte White

Finitura 2: Cassetto Bianco Opaco più top ed elemento a giorno Frassino Grigio.

*Finish 2: Drawer top and in Matte White color, open cabinet in Grey Ashwood color.*

*Finition 2: Tiroir en blanc mat et top et élément à jour en frêne gris.*

*Finish 2: Auszug Weiß matt und Waschtischplatte und Schrank graue Esche.*

*чистовая обработка 2: Ящик – белый матовый, открытый элемент и столешница – серый ясень.*

**FS 2**

kg 5

Specchio tondo con struttura in metallo

*Round mirror with metal frame*

*Miroir rond avec structure en métal*

*Rundspiegel mit Metallstrukturu*

*Круглое зеркало с металлической структурой*

**FS 3**

kg 0,2

Lampada magnetica per specchio FS 2

*Magnetic lamp for mirror FS 2*

*Lampe magnétique pour miroir FS2*

*Magnetische Lampe für Spiegel FS2*

*Светильник на магните для зеркала FS 2*

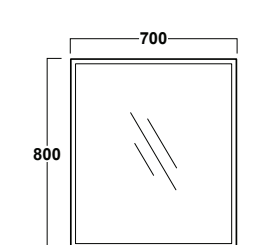
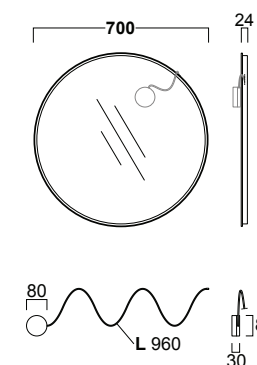
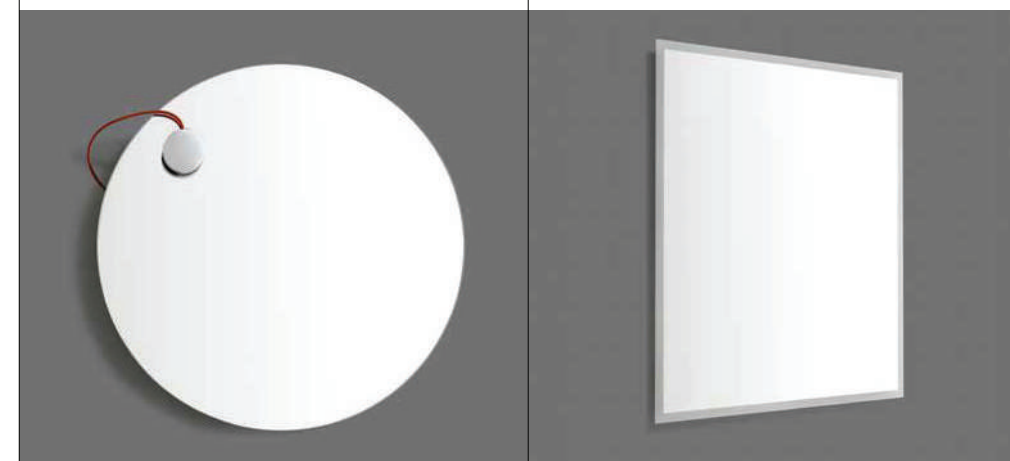
**PH 100**

kg 0,2

*Piletta universale in ABS per piano/lavabo*

*ABS universal wash basin top drain.*

*Bonde universelle en ABS pour plain de lavabo.*

*ABS Universalablaufgarnitur für Waschtischplatte.*

*Универсальный донный клапан из ABS для раковины.*



# arcade

DESIGN: UFFICIO TECNICO

Collezione che resiste al tempo. Suggestione 'antica' che sfida gli anni. Per eleganza assoluta, robustezza e affidabilità. Accessori coordinati, rubinetti, specchi, vasche in ghisa danno completezza e versatilità attuali. In una sola parola, il classico.

Arcade defies the passage of time. Absolute elegance with understated presence. The collection boasts a complete offering of accessories, taps, mirrors. Enameled bath tubs provide a modern upgrade. In one word Arcade is simply: classic.

Une collection qui résiste au temps. Suggestions 'antique' qui défi les années. Pour une élégance absolue, robustesse et fiabilité. Accessoires coordonnés, des robinets, des miroirs, des baignoires en fonte donnent l'exhaustion et une actuelle versatile. En une seule parole, le classique.

Diese Kollektion trotz der Zeit nicht nur dank absoluter Eleganz, sondern vor allem durch Widerstandsfähigkeit und Zuverlässigkeit. Koordinierte Zubehörteile, Armaturen, Spiegel, Gusseisen- und verleiher der Kollektion jene Vollständigkeit und Zuverlässigkeit, die wir von einer solchen Kollektion erwarten können. In einem Begriff ausgedrückt: das Klassische.

Вечно актуальная коллекция. «Старинный» дизайн, бросающий вызов времени. Абсолютная элегантность, прочность и надежность. Аксессуары, смесители, зеркала, чугунные и гидромассажные ванны добавляют комплектности и разнообразия коллекции. Одним словом, классика.



> **AR 802**  
Cassetta alta  
High-level cistern

< **AR 874**  
Consolle 105  
Console 105

< **ARM5**  
Mobile per consolle  
Cabinet for console

> **AR 833**  
Bidet senza brida  
Bidet without rim

> **AR 801**  
Vaso con scarico pavimento  
WC with floor outlet





AR 814 59x46x20

AR 864 90x56x20

AR 874 105x56x20



AR 824 68x54x21

AR 834 73x54x21

AR 844 68x54x21

AR 854 73x54x21



AR 835 67x49x20

AR 859 61x50,5x20

AR 884 57,5x57,5x21

AR 035 37,5x28x14

AR 036 34x34x14



AR 801 36,5x55x39  
AR 811 36,5x47x39

AR 823 36x57x39

AR 833 36x57x39

AR 841 36,5x51x30

AR 843 36x53x30



AR 821 36,5x68,5x39  
AR 831 36,5x68,5x39  
AR 822 37x19x43

AR 812 44x19,5x39

AR 812B 44x19,5x39

AR 802 44x19,5x39



ARM1 69x52x80,5

ARM2 83x54x80,5

ARM3 83x54x80,5

ARM4 97x54x80,5

ARM5 97x54x80,5



ARMD 70 69x52x80,5

ARMD 90 84x53x80,5

ARMC 90 84x53x80,5

ARMD 105 97x53x80,5

ARMC 105 97x53x80,5



ARMV1 48x36x182

ARMV2 43x37x168

ARS1 63x116

ARS2 83x116

Il fascino di ieri  
nella realtà di oggi.

The best of yesterday for living today.  
Le charme d'hier dans la réalité d'aujourd'hui.  
Die Faszination von Gestern in der Realität von Heute.  
Очарование классики в современной жизни.

> **ARS 2**  
Specchio 83  
Mirror 83

> **AR 864**  
Consolle 90  
Console 90

> **ARMD 90**  
Mobile per consolle  
Cabinet for console

> **AR 801**  
Vaso scarico pavimento  
WC with floor outlet

< **AR 812B**  
Cassetta a zaino  
Low-level cistern

< **AR 833**  
Bidet monoforo senza brida  
Single hole bidet without rim

**AR 874**

Consolle 105. Installazione su ARMD 105, ARMC 105, struttura, gambe o mensole  
 Console 105. To be mounted on ARMD 105, ARMC 105 stand/legs/brackets  
 Console 105. Installation sur ARMD 105, ARMC 105, structure, pieds ou étagères  
 Konsole 105. Installation auf ARMD 105, ARMC 105, Undergestell, Stützfuß oder Halterung  
 Консоль 105. Установка на ARMD 105, ARMC 105, керамические ноги или кронштейны

**AR 864**

Consolle 90. Installazione su ARMD 90, ARMC 90, struttura, gambe o mensole  
 Console 90. To be mounted on ARMD 90, ARMC 90, stand/legs/brackets  
 Console 90. Installation sur ARMD 90, ARMC 90, structure, pieds ou étagères  
 Konsole 90. Installation auf ARMD 90, ARMC 90, Undergestell, Stützfuß oder Halterung  
 Консоль 90. Установка на ARMD 90, ARMC 90, керамические ноги или кронштейны



**ACCESSORI DI COMPLETAMENTO**  
**ACCESSORIES AVAILABLE**

**ARMC 90/ARMD 90** Mobile per consolle AR 864  
 Cabinet for console AR 864

**ARMC 105/ARMD 105** Mobile per consolle AR 874  
 Cabinet for console AR 874

**GB 001** Gamba in ceramica  
 Ceramic leg

**AR CG1** Struttura per AR 864  
 Stand for AR 864

**AR CG2** Struttura per AR 874  
 Stand for AR 874

**MNSLEN** Mensola in ceramica  
 Ceramic bracket

**MNSAR** Coppia mensole in metallo  
 A set of metal brackets

**ARM1**

Mobile cm. 69 per lavabo AR834 con cestone. Finitura bianco / noce  
*Cm.69 cabinet for wash basin AR834 with basket. White/walnut finish*  
*Meuble cm.69 pour vasque AR834 avec panier. Finition blanc/noyer*  
*Waschtischunterbau cm.69 fuer Waschtisch AR834 mit Korb. weiß / Nussbaum*  
*тумба см.69 под раковину AR834 с ящиком. дверцами цвет белый/орех.*

**ARM2**

Mobile cm. 83 a terra per consolle AR864 con cestone. Finitura bianco / noce  
*Cm.83 cabinet for console basin AR864 with basket. White/walnut finish*  
*Meuble cm.83 pour console AR864 avec panier. finition blanc/noyer*  
*Waschtischunterbau cm.83 fuer Waschtisch AR864 mit Korb., weiß / Nussbaum*  
*тумба см.83 напольная под консоль AR864 с ящиком. дверцами цвет белый/орех.*

**ARM3**

Mobile cm. 83 sospeso per consolle AR864 con cestone. Finitura bianco / noce  
*Cm.83 wall hung cabinet for console basin AR864 with basket. White/walnut finish*  
*Meuble suspendu cm.83 pour console AR864 avec panier. Finition blanc/noyer*  
*Haenge-Waschtischunterbau cm.83 fuer Waschtisch AR864 mit Korb. weiß / Nussbaum*  
*тумба см.83 подвесная под консоль AR864 с ящиком.. дверцами цвет белый/орех.*

**ARM4**

Mobile cm. 97 a terra per consolle AR874 con cestone. Finitura bianco / noce  
*Cm.97 cabinet for console basin AR874 with basket. White/walnut finish*  
*Meuble cm.97 pour console AR874 avec panier. Finition blanc/noyer*  
*Waschtischunterbau cm.97 fuer Waschtisch AR874 mit Korb. weiß / Nussbaum*  
*тумба см.97 напольная под консоль AR874 с ящиком. дверцами цвет белый/орех.*

**ARM5**

Mobile cm. 97 sospeso per consolle AR874 con cestone. Finitura bianco / noce  
*Cm.97 wall hung cabinet for console basin AR874 with basket. White/walnut finish*  
*Meuble suspendu cm.97 pour console AR874 avec panier. Finition blanc/noyer*  
*Haenge-Waschtischunterbau cm.97 fuer Waschtisch AR874 mit Korb. weiß / Nussbaum*  
*тумба см.97 подвесная под консоль AR874 с ящиком. дверцами цвет белый/орех.*

**AR 874**

Consolle 105. Installazione  
 su ARMD 105, ARMC 105  
*Console 105. To be mounted  
 on ARMD 105, ARMC 105*  
*Console 105. Installation  
 sur ARMD 105, ARMC 105*  
*Konsole 105. Installation  
 auf ARMD 105, ARMC 105*  
*Консоль 105. Установка  
 на ARMD 105, ARMC 105*

**AR 874**

Consolle 105. Installazione  
su ARMD 105, ARMC 105  
Console 105. To be mounted  
on ARMD 105, ARMC 105  
Console 105. Installation  
sur ARMD 105, ARMC 105  
Konsole 105. Installation  
auf ARMD 105, ARMC 105  
Консоль 105. Установка  
на ARMD 105, ARMC 105

**ARMD 105**

Mobile per consolle AR 874 con ante dritte finitura bianco / noce  
Cabinet for console AR 874 with straight doors white/walnut finish  
Meuble pour console AR 874 avec portes droites finition blanc/noyer  
Unterbau für Waschtisch AR 874 mit geraden Türen, weiß / Nussbaum  
Тумба под раковину AR 874 с прямыми дверцами цвет белый/орех.

**ARMC 105**

Mobile per consolle AR 874 con ante curve finitura bianco / noce  
Cabinet for console AR 874 with curved doors white/walnut finish  
Meuble pour console AR 874 avec portes galbées finition blanc/noyer  
Unterbau für Waschtisch AR 874 mit gebogenen Türen, weiß / Nussbaum  
Тумба под раковину AR 874 с изогнутыми дверцами цвет белый/орех.

**ARMD 90**

Mobile per consolle con ante dritte per AR 864 finitura bianco / noce  
Cabinet for console AR 864 with straight doors white/walnut finish  
Meuble pour console AR 864 avec portes droites finition blanc/noyer  
Unterbau für Waschtisch AR 864 mit geraden Türen, weiß / Nussbaum  
Тумба под раковину AR 864 с прямыми дверцами цвет белый/орех.

**ARMC 90**

Mobile per consolle con ante curve per AR 864 finitura bianco / noce  
Cabinet for console AR 864 with curved doors white/walnut finish  
Meuble pour console AR 864 avec portes galbées finition blanc/noyer  
Unterbau für Waschtisch AR 864 mit gebogenen Türen, weiß / Nussbaum  
Тумба под раковину AR 864 с изогнутыми дверцами цвет белый/орех.



**AR CG1**

Struttura per AR 864  
 Structure for console AR 864  
 Structure pour console AR 864  
 Untergestell für Konsole AR 864  
 Корпус для AR 864

**AR CG2**

Struttura per AR 874  
 Structure for console AR 874  
 Structure pour console AR 874  
 Untergestell für Konsole AR 874  
 Корпус для AR 874

**GB 001**

Gamba in ceramica per consolle AR 864 / AR 874  
 Ceramic leg for console AR 864 / AR 874  
 Pied en céramique pour consolle AR 864 / AR 874  
 Stützfuß in Keramik für Konsole AR 864 / AR 874  
 Керамическая нога для консолей AR 864 / AR 874

**MNSLEN**

Mensola in ceramica per consolle AR 864 / AR 874  
 Ceramic bracket for console AR 864 / AR 874  
 Étagère en céramique pour consolle AR 864 / AR 874  
 Halterung in Keramik für Konsole AR 864 / AR 874  
 Кронштейн керамический для консолей AR 864 / AR 874

**MNSAR**

Coppia mensole in metallo laccato bianco per consolle AR 864 / AR 874 e lavabi AR 824 / AR 834 / AR 854  
 A set of white lacquered metal brackets for console AR 864 / AR 874 and washbasin AR 824 / AR 834 / AR 854  
 Paire d'étagères laqué blanc pour consolle AR 864 / AR 874 et lavabos AR 824 / AR 834 / AR 854  
 Halterung, weiß lackiert für Konsole AR 864 / AR 874 und Waschbecken AR 824 / AR 834 / AR 854  
 Кронштейн, материал – лакированная латунь белого цвета.  
 Для консолей AR 864 / AR 874 - AR 824 / AR 834 / AR 854

**AR 864**

Consolle 90. Installazione su struttura AR CG1  
 Console 90. To be mounted on structure AR CG1  
 Console 90. Installation sur structure AR CG1  
 Konsole 90. Installation auf Untergestell AR CG1  
 Консоль 90. Установка на керамические AR CG1



**AR 824**

Lavabo 68 con spalliera  
 Washbasin 68 with upstand  
 Lavabo 68 avec dossier  
 Waschtisch 68 mit Rückenteil  
 Умывальник с настенной плитой 68

**AR 805**

Colonna  
 Pedestal  
 Colonne  
 Säule  
 Колонна

ACCESSORI DI COMPLEMENTO  
 ACCESSORIES AVAILABLE

AR 805 Colonna  
 Pedestal

MNSAR Coppia mensole in metallo laccato bianco  
 A set of white lacquered metal brackets

**AR 834**

Lavabo 73 con spalliera  
 Washbasin 73 with upstand  
 Lavabo 73 avec dossier  
 Waschtisch 73 mit Rückenteil  
 Умывальник с настенной плитой 73

**ARMD 70**

Mobile per lavabo AR 834 con ante dritte finitura bianco / noce  
 Cabinet for washbasin AR 834 with straight doors white/walnut finish  
 Meuble pour lavabo AR 834 avec portes droites finition blanc/noyer  
 Waschtischunterschrank für Waschtisch AR 834 mit geraden Türen, weiß / Nussbaum  
 Тумба под раковину AR 834 с прямыми дверцами цвет белый/орех



ACCESSORI DI COMPLEMENTO  
 ACCESSORIES AVAILABLE

ARMD 70 Mobile per lavabo AR 834  
 Cabinet for washbasin AR 834

AR 805 Colonna  
 Pedestal

MNSAR Coppia mensole in metallo laccato bianco  
 A set of white lacquered metal brackets

**AR 814**

Lavabo 59 con spalliera  
 Washbasin 59 with upstand  
 Lavabo 59 avec dossier  
 Waschtisch 59 mit Rückenteil  
 Умывальник с настенной плитой 59

**ARS1**

Specchio cm 63 finitura bianco  
 Mirror cm 63 white finish  
 Miroir cm 63 finition blanc  
 Spiegel 63 cm, weiß  
 Зеркало 63 см цвет белый



ACCESSORI DI COMPLEMENTAMENTO  
 ACCESSORIES AVAILABLE

**AR 815** Colonna  
 Pedestal

**AR 844**

Lavabo 68 senza spalliera  
 Washbasin 68 without upstand  
 Lavabo 68 sans dossier  
 Waschtisch 68 ohne Rückenteil  
 Умывальник без настенной плиты 68

**AR 805**

Colonna  
 Pedestal  
 Colonne  
 Säule  
 Колонна

**AR 854**

Lavabo 73 senza spalliera  
 Washbasin 73 without upstand

ACCESSORI DI COMPLEMENTAMENTO  
 ACCESSORIES AVAILABLE

**AR 805** Colonna  
 Pedestal

**MNSAR** Coppia mensole in metallo laccato bianco  
 A set of white lacquered metal brackets

**AR 835**

Lavabo 67 semincasso  
 Semi inset washbasin 67  
 Lavabo semi-encastré 67  
 Halbeingelassener Waschtisch 67  
 Раковина 67 полувстроенная

**AR 859**

Lavabo ad incasso  
 Fully inset washbasin  
 Lavabo encastré  
 Eingelassener Waschtisch  
 Раковина встроенная



**AR 884**

Lavabo 57 ad angolo  
 Corner washbasin 57  
 Lavabo 57 à angle  
 Eckwaschbecken 57  
 Раковина 57 угловая

**AR 894**

Mensola in ceramica sotto lavabo  
 Ceramic under basin shelf  
 Étagère en céramique sous lavabo  
 Ablage in Keramik, montiert unter  
 Керамическая полка под раковину

**1011CR**

Struttura ad angolo cromo  
 Corner stand chrome-finish  
 Structure à angle en chrome  
 Eckgestell für Waschtisch in chrom  
 Угловая структура Хром

**AR 035**

Lavamani 37 sospeso  
 Wall hung wash-hand basin 37  
 Lave-mains suspendu 37  
 Handwaschbecken wandhängend 37  
 Маленькая подвесная раковина 37

**AR 036**

Lavamani 34 ad angolo sospeso  
 Wall hung corner wash-hand basin 34



**ACCESSORI DI COMPLETAMENTO**  
**ACCESSORIES AVAILABLE**

**1011CR / 1011BR / 1011OR** Struttura ad angolo per lavabo  
 Corner stand for washbasin  
**AR 894** Mensola in ceramica sotto lavabo  
 Ceramic shelf under basin for

**AR 823**

Bidet monoforo con brida  
 Single hole bidet with rim supply  
 Bidet mono trou avec une bride  
 Bidet, Einloch, mit Schelle für Dreilocharmatur  
 Биде с желобом по периметру

**AR 811**

Vaso con scarico a parete  
 WC with wall outlet  
 Cuvette avec décharge au mur  
 WC, verkleidet mit Wandanschluss  
 Унитаз приставной с горизонтальным сливом

**ACCESSORI DI COMPLETAMENTO**  
**ACCESSORIES AVAILABLE**

Coprivaso in poliestere con cerniere cromo **AR 002** o cerniere oro/bronzo **AR 003**  
 Polyester toilet seat with chrome finish hinges **AR 002** or gold/bronze finish hinges **AR 003**  
 Coprivaso in legno color noce con cerniere cromo **AR 004** o cerniere oro/bronzo **AR 005**  
 Wooden toilet seat walnut-finish with chrome-finish hinges **AR 004** or gold/bronze-finish hinges **AR 005**  
 Coprivaso in poliestere con cerniere rallentate cromo **AR 006** o cerniere oro/bronzo **AR 007**  
 Polyester toilet seat with chrome finish soft-closing hinges **AR 006** or gold/bronze finish hinges **AR 007**  
 Coprivaso in legno color noce con cerniere rallentate cromo **AR 008** o cerniere oro/bronzo **AR 009**  
 Wooden toilet seat walnut-finish with chrome-finish soft-closing hinges **AR 008** or gold/bronze finish hinges **AR 009**

**AR 833**

Bidet monoforo senza brida  
 Single hole bidet without rim  
 Bidet mono trou sans bride  
 Bidet, Einloch, ohne Schelle für Dreilocharmatur  
 Биде без желоба с одним отверстием  
 и двумя намеченными



**AR 801**

Vaso con scarico a pavimento  
*WC with floor outlet*  
*Cuvette évacuation verticale*  
*WC mit Bodenanschluss*  
*Унитаз с вертикальным сливом*

**AR 802**

Cassetta con coperchio a installazione alta  
*High-level cistern with lid*  
*Réservoir avec couvercle à installation haute*  
*Spülkasten mit Deckel, für Hochinstallation*  
*Высокий бачок с крышкой*

**R 01**

Batteria di scarico esterna per cassetta alta  
*Flush mechanism for high level cistern*  
*Batterie de décharge extérieure pour réservoir haute*  
*Aufputz-Spülgarnitur für hohen Spülkasten*  
*Наружный механизм слива для высокого бачка*

**ACCESSORI DI COMPLETAMENTO**  
**ACCESSORIES AVAILABLE**

Coprivaso in poliestere con cerniere cromo **AR 002**  
 o cerniere oro/bronzo **AR 003**  
*Polyester toilet seat with chrome finish hinges AR 002*  
*or gold/bronze finish hinges AR 003*  
 Coprivaso in legno color noce con cerniere cromo **AR 004**  
 o cerniere oro/bronzo **AR 005**  
*Wooden toilet seat walnut-finish with chrome-finish*  
*hinges AR 004 or gold/bronze-finish hinges AR 005*

**AR 801**

Vaso con scarico a pavimento  
*WC with floor outlet*  
*Cuvette évacuation verticale*  
*WC mit Bodenanschluss*  
*Унитаз с вертикальным сливом*

**AR 812B**

Cassetta a zaino con coperchio, foro frontale  
*Low-level cistern with lid front hole*  
*Réservoir mi-hauteur avec couvercle*  
*percement frontal*  
*Niedrigstand-Spülkasten mit Deckel mit*  
*Betätigung von vorne*  
*Средний бачок с крышкой и с*  
*фронтальным отверстием*

Coprivaso in poliestere con cerniere rallentate  
 cromo **AR 006** o cerniere oro/bronzo **AR 007**  
*Polyester toilet seat with chrome finish soft-closing*  
*hinges AR 006 or gold/bronze finish hinges AR 007*  
 Coprivaso in legno color noce con cerniere  
 rallentate cromo **AR 008** o cerniere oro/bronzo **AR 009**  
*Wooden toilet seat walnut-finish with chrome-finish*  
*soft-closing hinges AR 008 or gold/bronze*  
*finish hinges AR 009*



**AR 843**

Bidet sospeso monoforo  
 Wall hung bidet with single tap hole  
 Bidet suspendu mono trou  
 Hänge-Bidet, Einloch  
 Биде подвесное с одним отверстием

**AR 841**

Vaso sospeso "Rimless"  
 "Rimless" wall hung WC  
 Cuvette suspendue "Rimless"  
 "Rimless" Hänge-WC  
 Унитаз подвесной "Rimless"



**ACCESSORI DI COMPLETAMENTO**  
**ACCESSORIES AVAILABLE**

Coprivaso in poliestere con cerniere cromo **AR 002** o cerniere oro/bronzo **AR 003**  
 Polyester toilet seat with chrome finish hinges **AR 002** or gold/bronze finish hinges **AR 003**  
 Coprivaso in legno color noce con cerniere cromo **AR 004** o cerniere oro/bronzo **AR 005**  
 Wooden toilet seat walnut-finish with chrome-finish hinges **AR 004** or gold/bronze-finish hinges **AR 005**

**AR 821**

Vaso monoblocco con scarico a pavimento  
 Close coupled WC with floor outlet  
 Cuvette mono bloc avec décharge au sol  
 Monoblock-WC mit Bodenanschluss  
 Унитаз моноблок с вертикальным сливом

**AR 822**

Cassetta con coperchio per vaso monoblocco  
 Cistern with lid for close coupled WC  
 Réservoir avec couvercle pour cuvette mono bloc  
 Monoblock-Spülkasten  
 Бачок с крышкой для унитаза моноблок

Coprivaso in poliestere con cerniere rallentate cromo **AR 006** o cerniere oro/bronzo **AR 007**  
 Polyester toilet seat with chrome finish soft-closing hinges **AR 006** or gold/bronze finish hinges **AR 007**  
 Coprivaso in legno color noce con cerniere rallentate cromo **AR 008** o cerniere oro/bronzo **AR 009**  
 Wooden toilet seat walnut-finish with chrome-finish soft-closing hinges **AR 008** or gold/bronze finish hinges **AR 009**

**ARS2**

Specchio cm 83 finitura bianco/noce  
 Mirror cm 83 white/walnut finish  
 Miroir cm 83 finition blanc/noyer  
 Spiegel 83 cm, weiß / Nussbaum  
 Зеркало 83 см цвет белый/орех

**ARS1**

Specchio cm 63 finitura bianco/noce  
 Mirror cm 63 white/walnut finish  
 Miroir cm 63 finition blanc/noyer  
 Spiegel 63 cm, weiß / Nussbaum  
 Зеркало 63 см цвет белый/орех

**ARMV2**

Mobile con vetrina e cassetto finitura bianco/noce  
 Cabinet with show case and drawer white/walnut finish  
 Meuble avec vitrine et tiroir finition blanc/noyer  
 Beistell Vitrine mit Fenster und Schublade, weiß / Nussbaum  
 Шкаф с витриной и ящиком цвет белый/орех

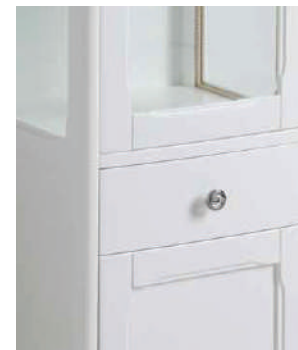
**ARMV1**

Mobile con vetrina finitura bianco/noce  
 Cabinet with show case white/walnut finish  
 Meuble avec vitrine finition blanc/noyer  
 Beistell Vitrine, weiß / Nussbaum  
 Шкаф с витриной цвет белый/орех





**AR 035**

kg 5

Lavamani 37 sospeso predisposto per rubinetteria monoforo destra e sinistra

Wall hung wash-hand basin 37 pre-punched for right and left tap holes

Lave mains 37 suspendu prédisposé pour robinet mono trou droite et gauche

Handwaschbecken 37, wandhängend, für Einlocharmatur rechts oder links

Маленькая подвесная раковина 37 с намеченными отверстиями справа и слева

**AR 036**

kg 5

Lavamani 34 ad angolo sospeso predisposto per rubinetteria monoforo centrale o destra e sinistra

Wall hung corner wash-hand basin 34 pre-punched for central or right and left tap holes

Lave mains 34 à angle suspendu pour robinet mono trou central ou droite et gauche

Eckhandwaschbecken 34, wandhängend, für Einlocharmatur mittig, rechts oder links

Маленькая подвесная угловая раковина 34 с намеченными отверстиями справа и слева

**AR 884 / AR 894 mensola**

kg 16/9

Lavabo 57 ad angolo monoforo predisposto per rubinetteria a tre fori. Installazione sospesa o su struttura. Mensola in ceramica sotto lavabo

Single hole corner washbasin 57 pre-punched for three tap holes. Wall hung or to be mounted on stand. Ceramic under basin shelf

Lavabo 57 à angle mono trou prédisposé pour robinet à trois trous. Installation suspendue ou sur une structure. Étagère en céramique sous lavabo

Eckwaschbecken 57, Einloch, für Dreilocharmatur vorgesehen, wandhängend oder auf Gestell. Ablage in Keramik, montiert unter dem Waschbecken. Ablage in Keramik, montiert unter

Раковина 57 угловая с одним отверстием и двумя намеченными под смеситель на 3 отверстия. Установка - подвесная или на структуре. Керамическая полка под раковину

**1011CR/1011BR/1011OR**

kg 3,8

Struttura ad angolo per lavabo AR 884 e per mensola AR 894 cromo/bronzo/oro

Corner stand for washbasin AR 884 and for shelf AR 894 chrome/bronze/gold-finish

Structure à angle pour lavabo AR 884 et pour étagère AR 894 en chrome/bronze/or

Eckgestell für Waschtisch AR 884, für Ablage AR 894. Oberflächen in chrom/bronze/gold

Угловая структура для раковины AR 884 с полкой AR 894. Хром/Бронза/Золото

**AR 835**

kg 15

Lavabo 67 semincasso monoforo predisposto per rubinetteria a tre fori

Semi inset single hole washbasin 67 pre-punched for three tap holes

Lavabo 67 semi emboîté mono trou prédisposé pour robinet à trois trous

Halbeinbaubecken 67, Einloch, für Dreilocharmatur vorgesehen

Раковина 67 полувстроенная с одним отверстием и двумя намеченными под смеситель на 3 отверстия

**AR 859**

kg 11

Lavabo ad incasso monoforo predisposto per rubinetteria a tre fori

Fully inset single hole washbasin pre-punched for three tap holes

Lavabo emboîté mono trou prédisposé pour robinet à trois trous

Einbauwaschbecken, Einloch, für Dreilocharmatur vorgesehen

Раковина встроенная с одним отверстием и двумя намеченными под смеситель на 3 отверстия

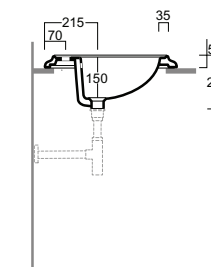
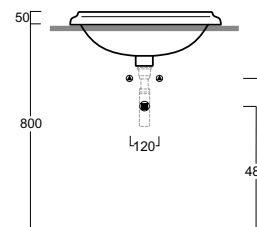
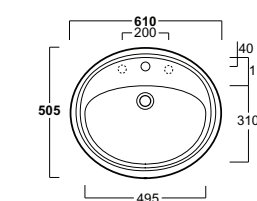
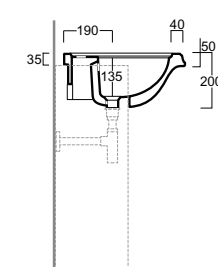
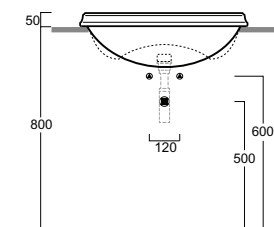
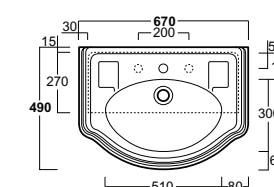
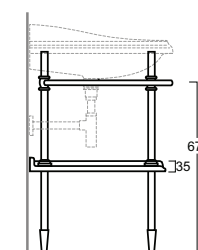
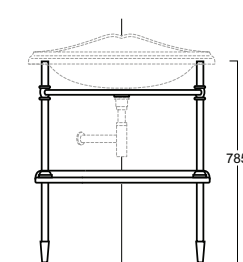
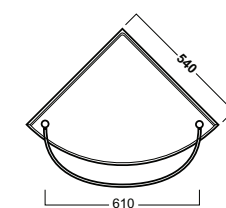
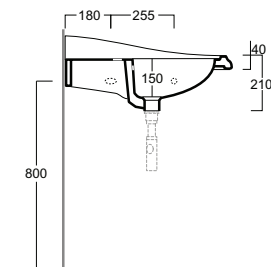
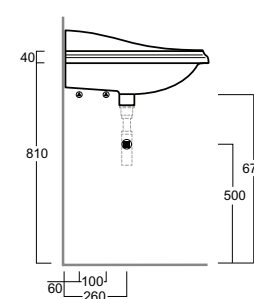
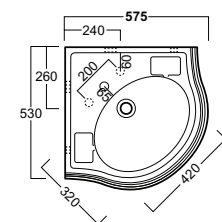
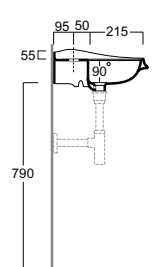
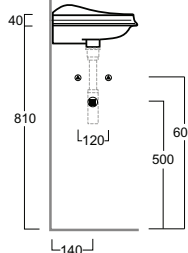
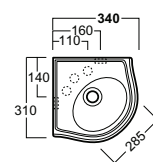
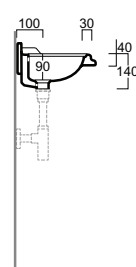
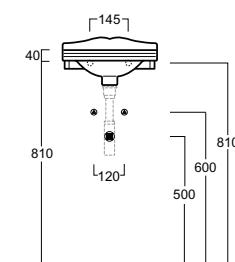
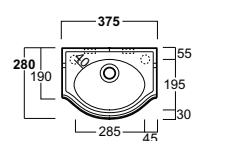

**AR 864**

kg 28

Consolle 90 monoforo predisposta per rubinetteria a tre fori. Installazione su ARMD 90, ARMC 90, struttura, gambe o mensole

Single hole console 90 pre-punched for three tap holes. To be mounted on ARMD 90, ARMC 90, stand, legs or brackets

Console 90 mono trou prédisposée pour robinet à trois trous. Installation sur ARMD 90, ARMC 90, structure, pieds ou étagères

Konsole 90, Einloch, für Dreilocharmatur vorgesehen, Installation auf ARMD 90, ARMC 90, Undergestell, Stützfuß oder Halterung

Консоль 90 с одним отверстием и двумя намеченными под смеситель на 3 отверстия. Установка на ARMD 90, ARMC 90, керамические ноги или кронштейны

**AR 874**

kg 33

Consolle 105 monoforo predisposta per rubinetteria a tre fori. Installazione su ARMD 105, ARMC 105, struttura, gambe o mensole

Single hole console 105 pre-punched for three tap holes. To be mounted on ARMD105, ARMC105, stand, legs or brackets

Console 105 mono trou prédisposée pour robinet à trois trous. Installation sur ARMD105, ARMC105, structure, pieds ou étagères

Konsole 105, Einloch, für Dreilocharmatur vorgesehen, Installation auf ARMD 105, ARMC 105, Undergestell, Stützfuß oder Halterung

Консоль 105 с одним отверстием и двумя намеченными под смеситель на 3 отверстия. Установка на ARMD 105, ARMC 105, керамические ноги или кронштейны

**ARMD 105**

kg 28

Mobile per consolle AR874 con ante dritte finitura bianco / noce

Cabinet for console AR874 with straight doors white/walnut finish

Meuble pour console AR 874 avec portes droites finition blanc/noyer

Unterbau für Waschtisch AR 874 mit geraden Türen, weiß / Nussbaum

Тумба под раковину AR874 с прямыми дверцами цвет белый/орех

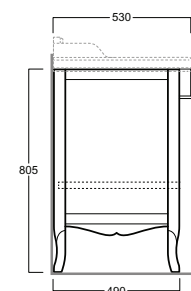
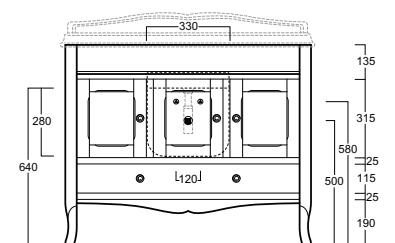
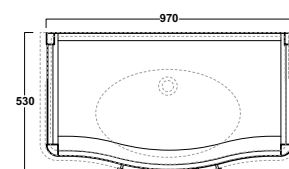
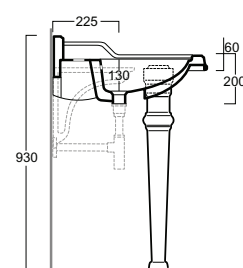
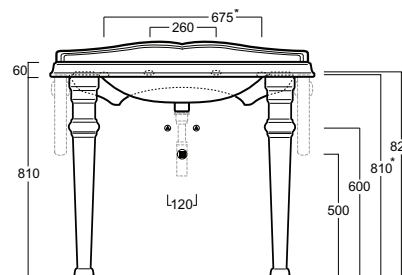
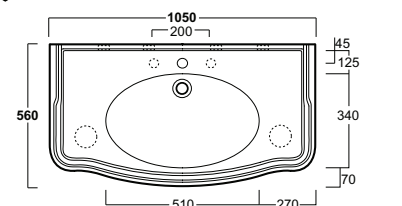
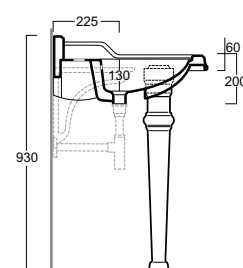
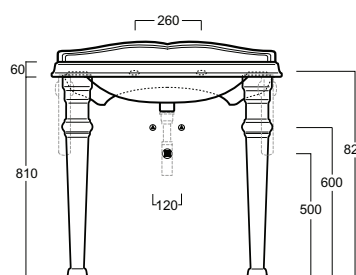
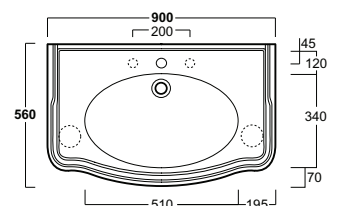
**ARMC 105**

kg 28

Mobile per consolle AR 874 con ante curve finitura bianco / noce

Cabinet for console AR 874 with curved doors white/walnut finish

Meuble pour console AR 874 avec portes galbées finition blanc/noyer

Unterbau für Waschtisch AR 874 mit gebogenen Türen, weiß / Nussbaum

Тумба под раковину AR 874 с изогнутыми дверцами цвет белый/орех

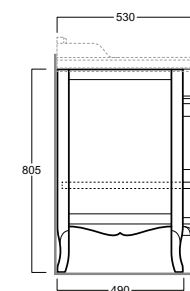
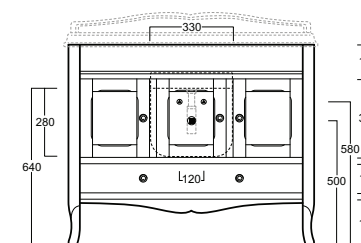
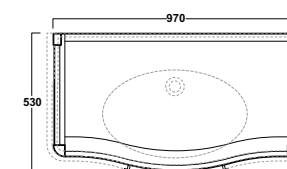
**ARMD 90**

kg 15

Mobile per consolle AR 864 con ante dritte finitura bianco / noce

Cabinet for console AR 864 with straight doors white/walnut finish

Meuble pour console AR 864 avec portes droites finition blanc/noyer

Unterbau für Waschtisch AR 864 mit geraden Türen weiß / Nussbaum

Тумба под раковину AR 864 с прямыми дверцами цвет белый/орех

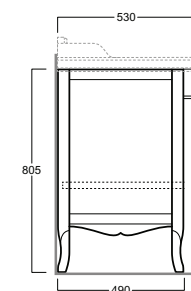
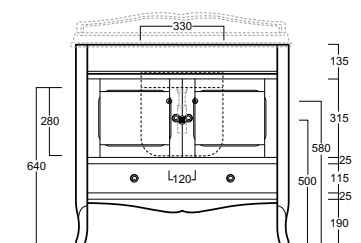
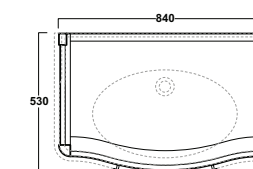
**ARMC 90**

kg 11

Mobile per consolle AR 864 con ante curve finitura bianco / noce

Cabinet for console AR 864 with curved doors white/walnut finish

Meuble pour console AR 864 avec portes galbées finition blanc/noyer

Unterbau für Waschtisch AR 864 mit gebogenen Türen, weiß / Nussbaum

Тумба под раковину AR 864 с изогнутыми дверцами цвет белый/орех

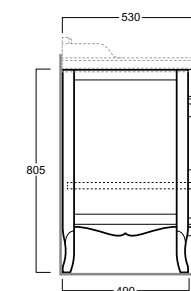
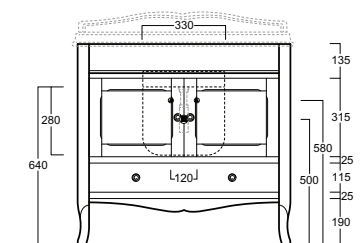
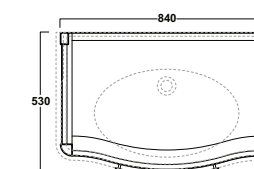

**ARM1**

kg 21

Mobile cm. 69 per lavabo AR834 con cestone.  
Finitura bianco / noce.

*Cm.69 cabinet for wash basin AR834 with basket.  
White/walnut finish.*

*Meuble cm.69 pour vasque AR834 avec panier.  
Finition blanc/noyer.*

*Waschtischunterbau cm.69 fuer Waschtisch  
AR834 mit Korb. weiß / Nussbaum.*

*тумба см.69 под раковину AR834 с ящиком.  
дверцами цвет белый/орех.*

**ARM2**

kg 25

Mobile cm. 83 a terra per consolle AR864 con  
cestone. Finitura bianco / noce.

*Cm.83 cabinet for console basin AR864 with  
basket. White/walnut finish.*

*Meuble cm.83 pour console AR864 avec panier.  
finition blanc/noyer.*

*Waschtischunterbau cm.83 fuer Waschtisch  
AR864 mit Korb., weiß / Nussbaum.*

*тумба см.83 напольная под консоль AR864 с  
ящиком. дверцами цвет белый/орех.*

**ARM3**

kg 25

Mobile cm. 83 sospeso per consolle AR864 con  
cestone. Finitura bianco / noce.

*Cm.83 wall hung cabinet for console basin AR864  
with basket. White/walnut finish.*

*Meuble suspendu cm.83 pour console AR864  
avec panier. Finition blanc/noyer.*

*Haenge-Waschtischunterbau cm.83 fuer  
Waschtisch AR864 mit Korb. weiß / Nussbaum.*

*тумба см.83 подвесная под консоль AR864 с  
ящиком.. дверцами цвет белый/орех.*

**ARM4**

kg 28

Mobile cm. 97 a terra per consolle AR874 con  
cestone. Finitura bianco / noce.

*Cm.97 cabinet for console basin AR874 with  
basket. White/walnut finish.*

*Meuble cm.97 pour console AR874 avec panier.  
Finition blanc/noyer.*

*Waschtischunterbau cm.97 fuer Waschtisch  
AR874 mit Korb. weiß / Nussbaum.*

*тумба см.97 напольная под консоль AR874 с  
ящиком. дверцами цвет белый/орех.*

**ARM5**

kg 28

Mobile cm. 97 sospeso per consolle AR874 con  
cestone. Finitura bianco / noce.

*Cm.97 wall hung cabinet for console basin AR874  
with basket. White/walnut finish.*

*Meuble suspendu cm.97 pour console AR874  
avec panier. Finition blanc/noyer.*

*Haenge-Waschtischunterbau cm.97 fuer  
Waschtisch AR874 mit Korb. weiß / Nussbaum.*

*тумба см.97 подвесная под консоль AR874 с  
ящиком. дверцами цвет белый/орех.*

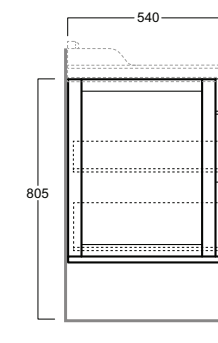
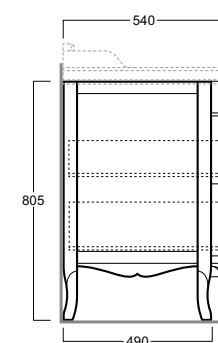
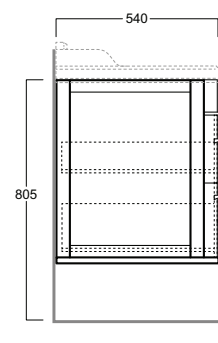
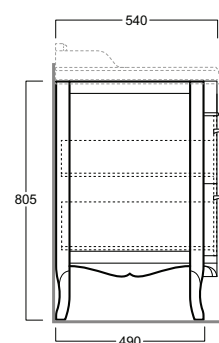
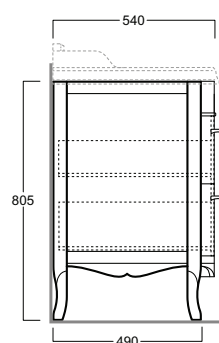
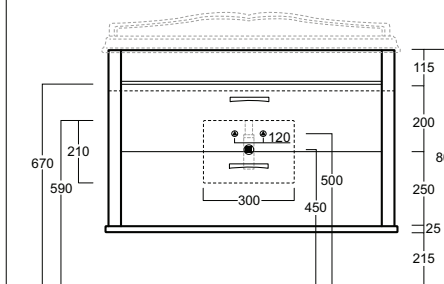
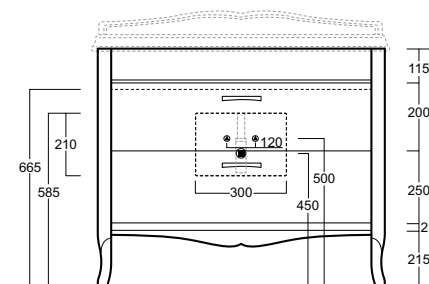
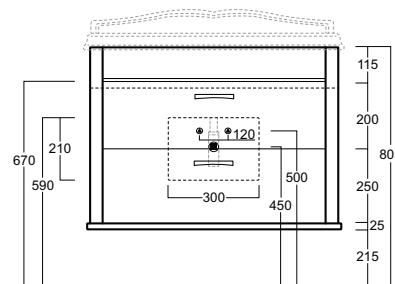
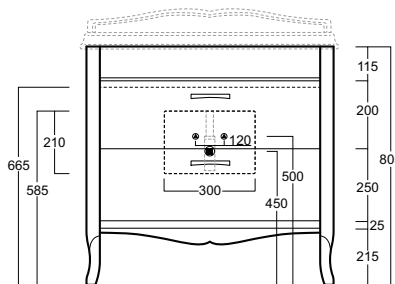
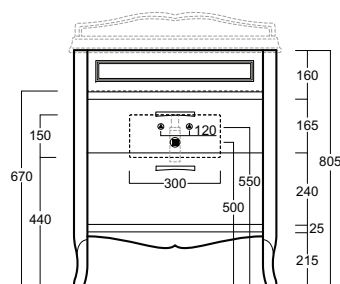
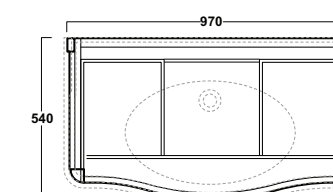
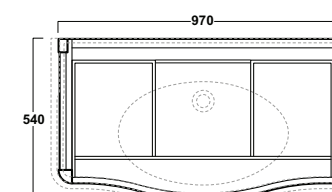
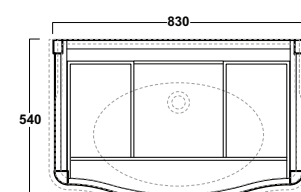
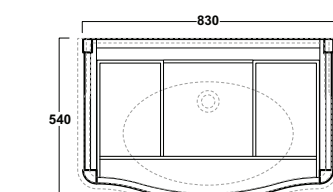
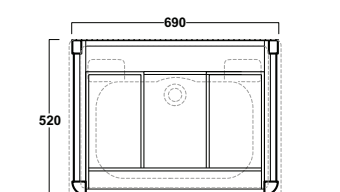
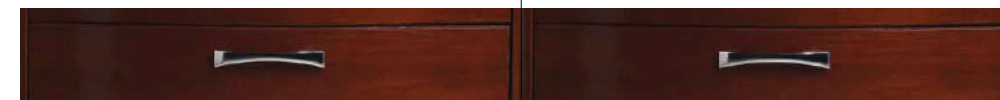
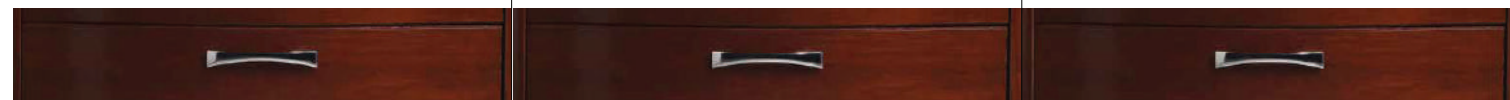

**AR CG1**

kg 5,4

Struttura per consolle AR 864

Stand for console AR 864

Structure pour console AR 864

Untergestell für Konsole AR 864

Корпус консоли для умывальника AR 864

**AR CG2**

kg 5,5

Struttura per consolle AR 874

Stand for console AR 874

Structure pour console AR 874

Untergestell für Konsole AR 874

Корпус консоли для умывальника AR 874

**GB 001**

kg 4

Gamba in ceramica per consolle AR 864 / AR 874.  
Necessarie due unità per installazione consolleCeramic leg for console AR 864 / AR 874.  
Two pieces are needed for the installationPied en céramique pour console AR 864 / AR 874.  
Deux pièces sont nécessaires pour l'installation de la consoleStützfuß in Keramik für Konsole AR 864 / AR 874.  
Es werden für Installation Konsole zwei Einheiten benötigt

Керамическая нога для консоли AR 864 / AR 874. Нужно 2 шт. для установки консоли

**MNSLEN**

kg 2

Mensola in ceramica per consolle AR 864 / AR 874. Necessarie due unità per installazione consolle

Ceramic bracket for console AR 864 / AR 874.  
Two pieces are needed for the installation

Etagère en céramique pour console AR 864 / AR 874. Deux pièces sont nécessaires pour l'installation de la console

Halterung in Keramik für Konsole AR 864 / AR 874. Es werden für Installation Konsole zwei Einheiten benötigt

Керамический кронштейн для консоли AR 864 / AR 874. Нужно 2 шт. для установки консоли

**MNSAR**

kg 3,2

Coppia mensole in metallo laccato bianco per consolle AR 864 / AR 874 e lavabi AR 824 / AR 834 / AR 854

A set of white lacquered metal brackets for console AR 864 / AR 874 and washbasin AR 824 / AR 834 / AR 854

Etagère laqué blanc pour console AR 864 / AR 874 et lavabos AR 824 / AR 834 / AR 854

Halterung, weiß lackiert für Konsole AR 864 / AR 874 und Waschbecken AR 824 / AR 834 / AR 854

Кронштейн, материал – лакированная латунь белого цвета. Для консолей AR 864 / AR 874 - AR 824 / AR 834 / AR 854

**AR 814 / AR 815**

kg 16/9

Lavabo 59 con spalliera monoforo predisposto per rubinetteria a tre fori. Installazione su colonna AR 815

Single hole washbasin 59 with upstand - pre-punched for three tap holes. To be mounted on pedestal AR 815

Lavabo 59 avec dossier mono trou prédisposé pour les robinets à trois trous. Installation sur colonne AR 815

Waschbecken 59 mit hohem Rand, Einloch, für Dreilocharmatur vorgesehen, Installation auf Säule AR 815

Умывальник 59 с настенной плитой с одним отверстием, предусмотренный для сантехнической арматуры на три отверстия. Установка на колонне AR 815

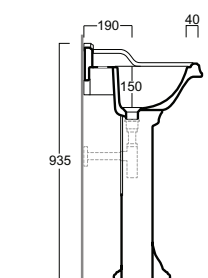
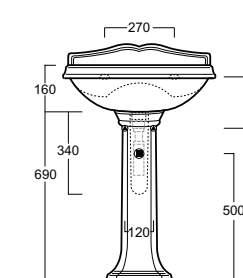
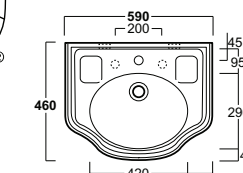
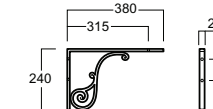
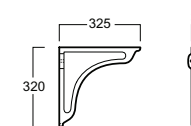
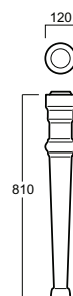
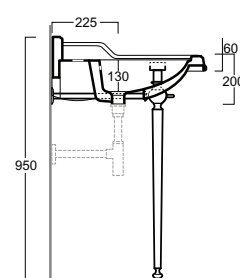
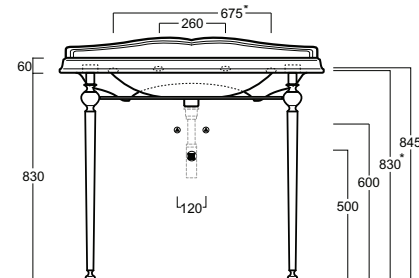
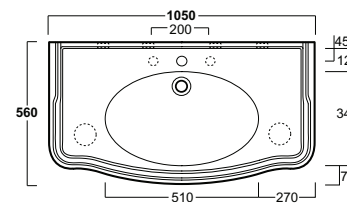
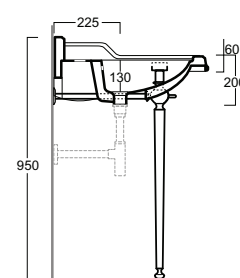
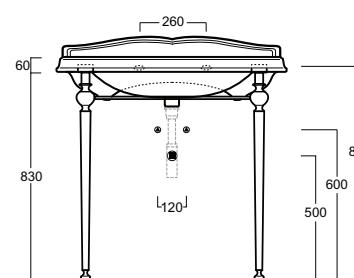
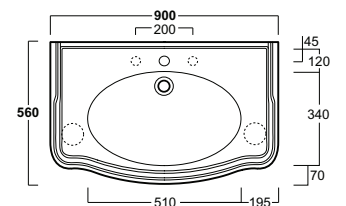

**AR 824 / AR 805**

kg 22/10

Lavabo 68 con spalliera monoforo predisposto per rubinetteria a tre fori. Installazione su colonna AR 805

*Single hole washbasin 68 with upstand - pre-punched for three tap holes. To be mounted on pedestal AR 805*

*Lavabo 68 avec dossier mono trois prédisposé pour robinet à trois trous. Installation sur colonne AR 805*

*Waschbecken 68 mit hohem Rand, Einloch, für Dreilocharmatur vorgesehen. Installation auf Säule AR 805*

*Умывальник 68 с настенной плитой с одним отверстием, предусмотренный для сантехнической арматуры на три отверстия. Установка на колонне AR 805*

**AR 834 / AR 805**

kg 23/10

Lavabo 73 con spalliera monoforo predisposto per rubinetteria a tre fori. Installazione su colonna AR 805 e ARMD 70

*Single hole washbasin 73 with upstand - pre-punched for three tap holes. To be mounted on pedestal AR 805 and ARMD 70*

*Lavabo 73 avec dossier mono trois prédisposé pour robinet à trois trous. Installation sur colonne AR 805 et ARMD 70*

*Waschbecken 73 mit hohem Rand, Einloch, für Dreilocharmatur vorgesehen. Installation auf Säule AR 805 und ARMD 70*

*Умывальник 73 с настенной плитой с одним отверстием, предусмотренный для сантехнической арматуры на три отверстия. Установка на колонне AR 805 и ARMD 70*

**ARMD 70**

kg 21

Mobile per lavabo AR 834 con ante dritte finitura bianco / noce

*Cabinet for washbasin AR834 with straight doors white/walnut finish*

*Meuble pour lavabo AR 834 avec portes droites finition blanc/noyer*

*Waschtischunterschrank für Waschtisch AR 834 mit geraden Türen, weiß / Nussbaum*

*Тумба под раковину AR 834 с прямыми дверцами цвет белый/орех*

**AR 844 / AR 805**

kg 22/10

Lavabo 68 senza spalliera monoforo predisposto per rubinetteria a tre fori. Installazione su colonna AR 805

*Single hole washbasin 68 without upstand - pre-punched for three tap holes. To be mounted on pedestal AR 805*

*Lavabo 68 sans dossier mono trou prédisposé pour les robinets à trois trous. Installation sur colonne AR 805*

*Waschbecken 68 ohne hohem Rand, Einloch, für Dreilocharmatur vorgesehen, Installation auf Säule AR 805*

*Умывальник 68 без настенной плиты с одним отверстием, предусмотренный для сантехнической арматуры на три отверстия. Установка на колонне AR 805*

**AR 854 / AR 805**

kg 23/10

Lavabo 73 senza spalliera monoforo predisposto per rubinetteria a tre fori. Installazione su colonna AR 805

*Single hole washbasin 73 without upstand - pre-punched for three tap holes. To be mounted on pedestal AR 805*

*Lavabo 73 sans dossier mono trois prédisposé pour robinet à trois trous. Installation on pedestal AR 805*

*Waschbecken 73 ohne hohem Rand, Einloch, für Dreilocharmatur vorgesehen. Installation auf Säule AR 805*

*Умывальник 73 без настенной плиты с одним отверстием, предусмотренный для сантехнической арматуры на три отверстия. Установка на колонне AR 805*

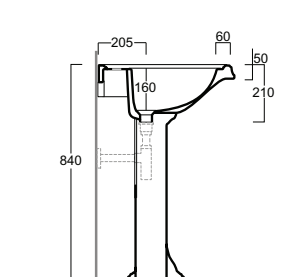
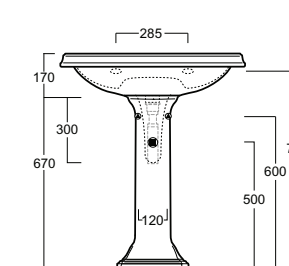
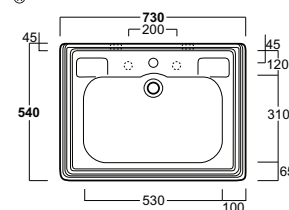
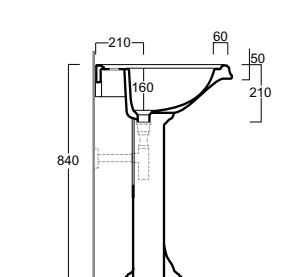
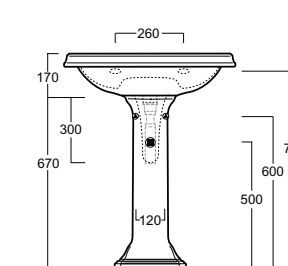
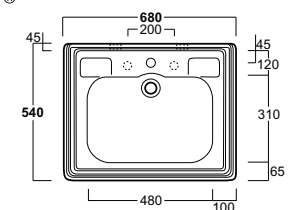
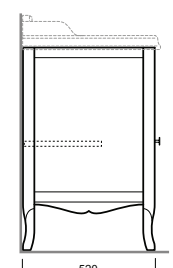
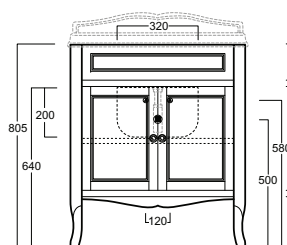
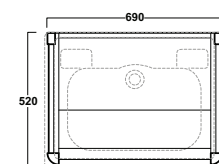
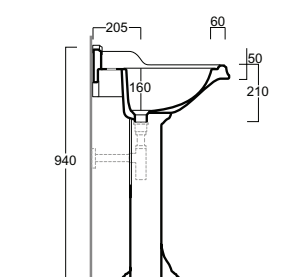
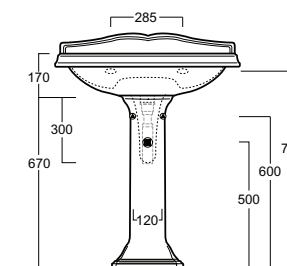
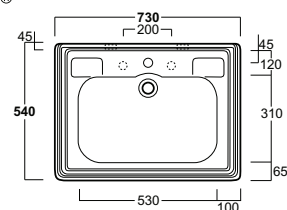
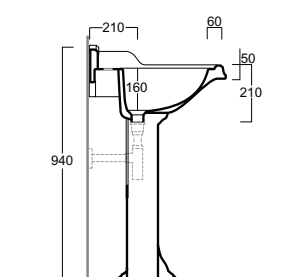
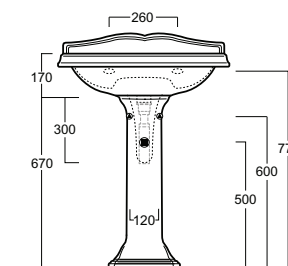
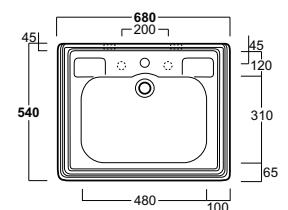

**AR 823**

kg 19

Bidet monoforo con brida predisposto per rubinetteria a tre fori

Single hole bidet with rim supply pre-punched for three tap holes

Bidet mono trou avec une bride pour robinetterie à trois trous

Bidet, Einloch, mit Schelle für Dreilocharmatur

Биде с желобом по периметру с одним отверстием и двумя намеченными под смеситель на 3 отверстия

**AR 833**

kg 17

Bidet monoforo senza brida predisposto per rubinetteria a tre fori

Single hole bidet without rim supply pre-punched for three tap holes

Bidet mono trou sans bride prédisposé pour robinetterie à trois trous

Bidet, Einloch, ohne Schelle für Dreilocharmatur

Биде без желоба с одним отверстием и двумя намеченными под смеситель на 3 отверстия

**AR 801**

kg 19

Vaso con scarico a pavimento

WC with floor outlet

Cuvette avec décharge au sol

WC mit Bodenanschluss

Унитаз с вертикальным сливом

**AR 811**

kg 19

Vaso con scarico a parete

WC with wall outlet

Cuvette avec décharge au mur

WC mit Wandanschluss

Унитаз с горизонтальным сливом

**AR 843**

kg 16/9

Bidet sospeso monoforo senza brida

Wall hung bidet with single tap hole without rim supply

Bidet suspendu mono trou sans bride

Hänge-Bidet, Einloch

Биде подвесное с одним отверстием

**AR 841**

kg 17

Vaso sospeso "Rimless"

"Rimless" wall hung WC

Cuvette suspendue "Rimless"

"Rimless" Hänge-WC

Унитаз подвесной "Rimless"

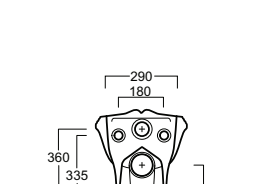
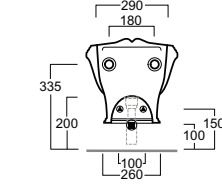
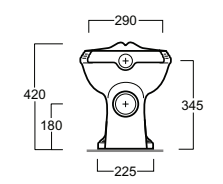
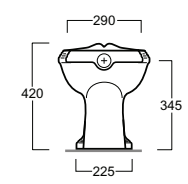
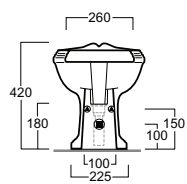
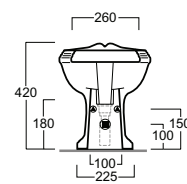
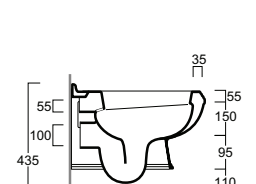
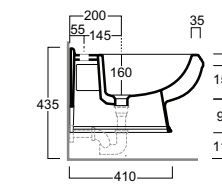
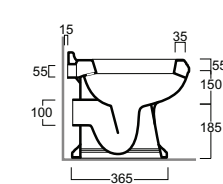
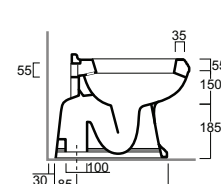
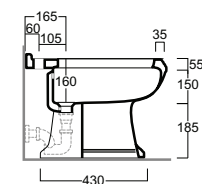
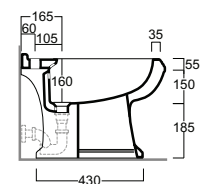
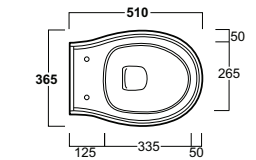
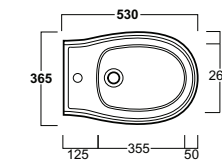
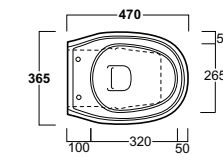
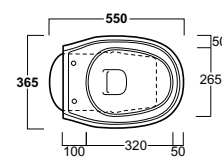
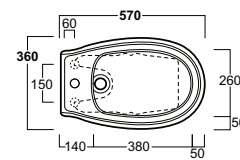
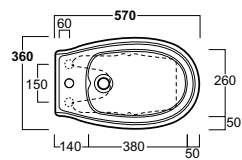

c

**AR 821 / AR 822**

kg 20

Vaso monoblocco con scarico a pavimento e cassetta con coperchio

*Close coupled WC with floor outlet and cistern with lid*

*Cuvette mono bloc avec décharge au sol, réservoir avec couvercle*

*Monoblock-WC mit Bodenanschluss, Monoblock-Spülkasten*

*Унитаз моноблок с вертикальным сливом и бачок с крышкой*

**AR 831 / AR 822**

kg 20

Vaso monoblocco con scarico a parete e cassetta con coperchio

*Close coupled WC with wall outlet and cistern with lid*

*Cuvette mono bloc avec décharge à mur, réservoir avec couvercle*

*Monoblock-WC mit Wandanschluss, Monoblock-Spülkasten*

*Унитаз моноблок с горизонтальным сливом и бачок с крышкой*

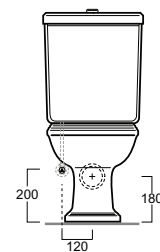
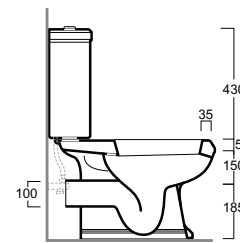
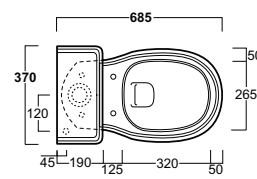
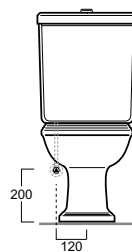
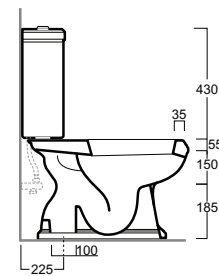
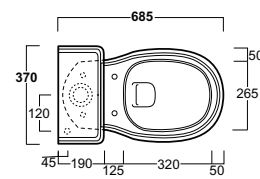
**AR 801 / AR 812**

kg 16/19

Cassetta a zaino con coperchio per vaso AR 801

*Low-level cistern with lid for wc AR 801*

*Réservoir mi-hauteur avec couvercle pour cuvette AR 801*

*Niedrigstand-Spülkasten mit Deckel für WC AR 801*

*Устанавливаемый сзади бачок с крышкой для унитаза AR 801*

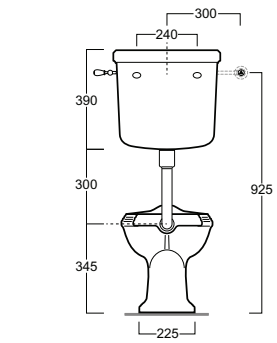
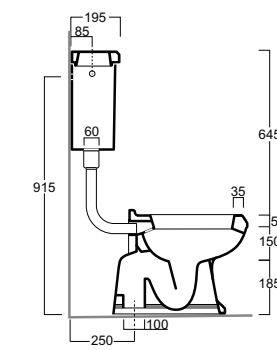
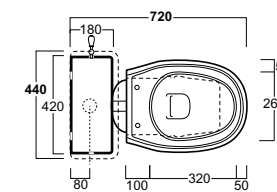
**AR 811 / AR 812**

kg 16/19

Cassetta a zaino con coperchio per vaso AR 811

*Low-level cistern with lid for wc AR 811*

*Réservoir mi-hauteur avec couvercle pour cuvette AR 811*

*Niedrigstand-Spülkasten mit Deckel für WC AR 811*

*Устанавливаемый сзади бачок с крышкой для унитаза AR 811*

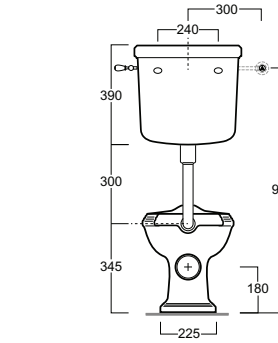
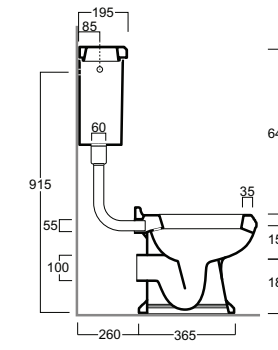
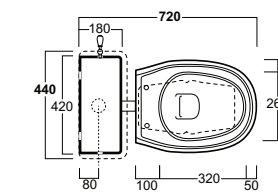
**AR 801 / AR 812B**

kg 16/19

Cassetta a zaino con coperchio, foro frontale per vaso AR 801

*Low-level cistern with lid front hole for wc AR 801*

*Réservoir mi-hauteur avec couvercle percement frontal pour WC AR 801*

*Niedrigstand-Spülkasten mit Deckel für WC AR 801 mit Betätigung von vorne*

*Средний бачок с крышкой и с фронтальным отверстием, для унитазов AR 801*

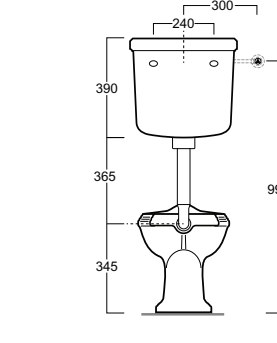
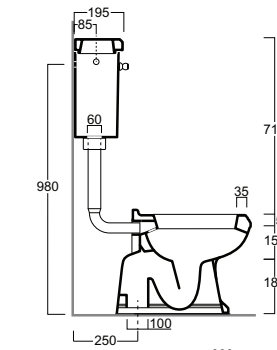
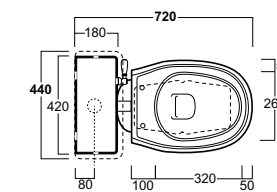

**AR 811 / AR 812B**

kg 16/19

Cassetta a zaino con coperchio, foro frontale per vaso AR 811

*Low-level cistern with lid front hole for wc AR 811*

*Réservoir mi-hauteur avec couvercle percement frontal pour WC AR 811*

*Niedrigstand-Spülkasten mit Deckel für WC AR 811 mit Betätigung von vorne*

*Средний бачок с крышкой и с фронтальным отверстием, для унитаза AR811*

**AR 801 / AR 802**

kg 17/19

Cassetta con coperchio ad installazione alta per vaso AR801

*High-level cistern with lid for wc AR 801*

*Réservoir avec couvercle à installation haute pour cuvette AR 801*

*Spülkasten mit Deckel, für Hochinstallation für WC AR 801*

*Высокий бачок с крышкой для унитаза AR 801*

**AR 811 / AR 802**

kg 17/19

Cassetta con coperchio ad installazione alta per vaso AR 811

*High-level cistern with lid for wc AR 811*

*Réservoir avec couvercle à installation haute pour cuvette AR 811*

*Spülkasten mit Deckel, für Hochinstallation für WC AR 811*

*Высокий бачок с крышкой для унитаза AR 811*

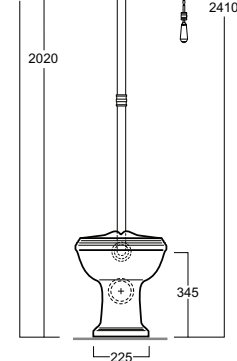
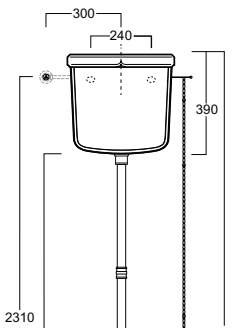
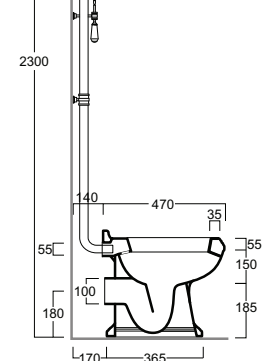
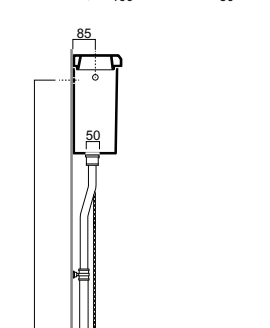
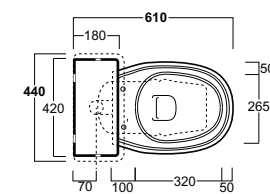
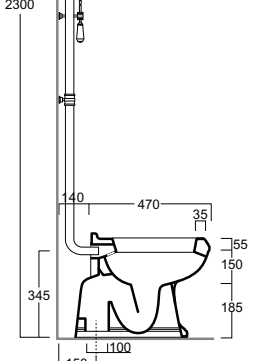
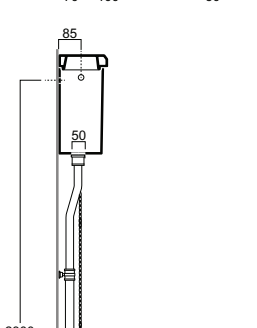
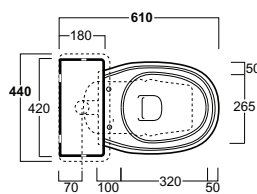
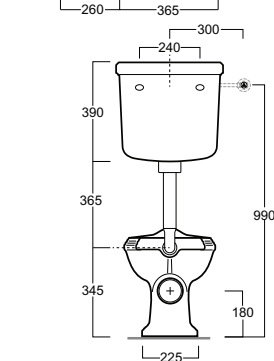
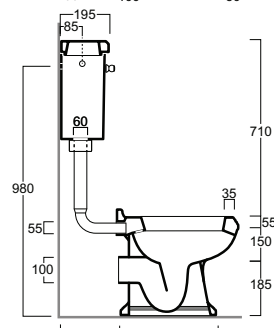
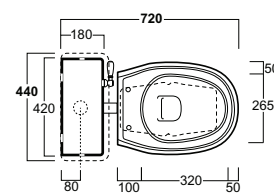
**AR 002**

kg 3

Coprivaso in poliester e con cerniere cromo  
*Polyester toilet seat with chrome-finish hinges*  
*Abattant en polyester avec des charnières chrome*  
*WC Deckel in Polyester mit Chromscharnieren*  
*Сиденье, полиэстер, шарниры - хром*

**AR 003**

kg 3

Coprivaso in poliester e con cerniere oro/bronzo  
*Polyester toilet seat with gold/bronze-finish hinges*  
*Abattant en polyester avec des charnières or/ bronze*  
*WC Deckel in Polyester mit Scharnieren in Gold/Bronze*  
*Сиденье, полиэстер, шарниры - золото/бронза*

**AR 004**

kg 3

Coprivaso in legno color noce con cerniere cromo  
*Wooden toilet seat walnut-finish with chrome-finish hinges*  
*Abattant en bois couleur noyer avec des charnières chrome*  
*WC- Sitz und Deckel in Holz, Farbe Nußbaum, mit Chromscharnieren*  
*Сиденье, дерево - цвет- орех, шарниры - хром*

**AR 005**

kg 3

Coprivaso in legno color noce con cerniere oro/bronzo  
*Wooden toilet seat walnut-finish with gold/bronze-finish hinges*  
*Abattant en bois couleur noyer avec des charnières or/bronze*  
*WC- Sitz und Deckel in Holz, Farbe Nußbaum, mit Scharnieren in Gold/Bronze*  
*Сиденье, дерево - цвет- орех, шарниры - золото/бронза*

**AR 006**

kg 3

Coprivaso in poliester e con cerniere rallentate cromo  
*Polyester toilet seat with chrome-finish soft-closing hinges*  
*Abattant en polyester avec charnières avec frein chrome*  
*WC-Sitz in Polyester mit Chromscharnieren mit Absenkautomatik*  
*Сиденье, полиэстер, петли хром, с микролифтом*

**AR 007**

kg 3

Coprivaso in poliester e con cerniere rallentate oro/bronzo  
*Polyester toilet seat with gold/bronze-finish soft-closing hinges*  
*Abattant en polyester avec charnières avec frein or/bronze*  
*WC-Sitz in Polyester mit verlangsamten Scharnieren in gold / bronze*  
*Сиденье, полиэстер, петли золото/бронза, с микролифтом*

**AR 008**

kg 3

Coprivaso in legno color noce con cerniere rallentate cromo  
*Wooden toilet seat walnut-finish with chrome-finish soft-closing hinges*  
*Abattant en bois avec charnières avec frein chrome*  
*WC-Sitz in Holz „Nuss“ mit verlangsamten Scharnieren in chrom*  
*Сиденье, дерево, цвет - орех, петли хром, с микролифтом*

**AR 009**

kg 3

Coprivaso in legno color noce con cerniere rallentate oro/bronzo  
*Wooden toilet seat walnut-finish with gold/bronze-finish soft-closing hinges*  
*Abattant en bois avec charnières avec frein or/bronze*  
*WC-Sitz in Holz „Nuss“ mit verlangsamten Scharnieren in gold/bronze*  
*Сиденье, дерево, цвет - орех, петли золото/бронза, с микролифтом*



**ARMV1**

kg 30

Mobile con vetrina finitura bianco / noce

*Cabinet with show case white/walnut finish**Meuble avec vitrine finition blanc/noyer**Beistell Vitrine weiß / Nussbaum**Шкаф с витриной цвет белый/орех***ARMV2**

kg 27

Mobile con vetrina e cassetto finitura bianco / noce

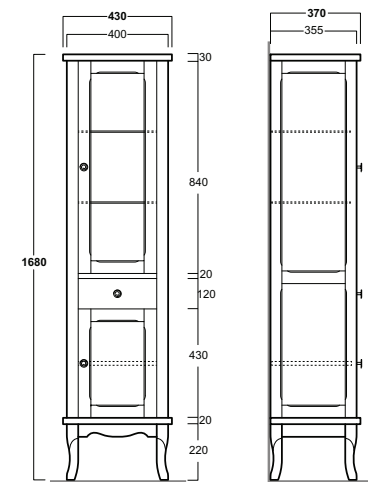
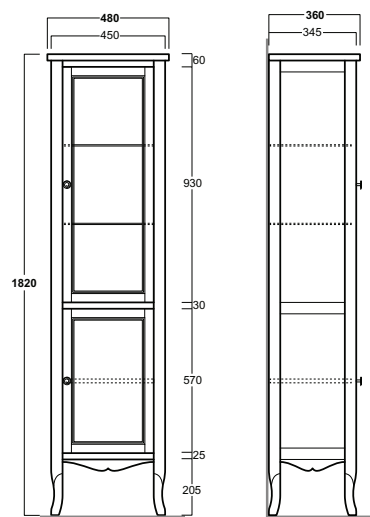
*Cabinet with show case and drawer white/walnut finish**Meuble avec vitrine et tiroir finition blanc/noyer**Beistell Vitrine mit Fenster und Schublade, weiß / Nussbaum**Шкаф с витриной и ящиком цвет белый/орех***ARS1**

kg 7

Specchio cm 63 finitura bianco / noce

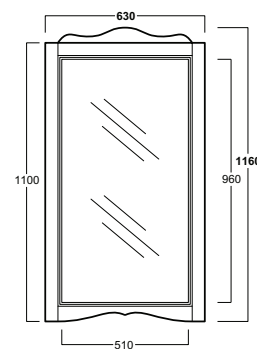
*Mirror cm 63 white/walnut finish**Miroir cm 63 finition blanc/noyer**Spiegel 63 cm weiß / Nussbaum**Зеркало 63 см цвет белый/орех***ARS2**

kg 10

Specchio cm 83 finitura bianco / noce

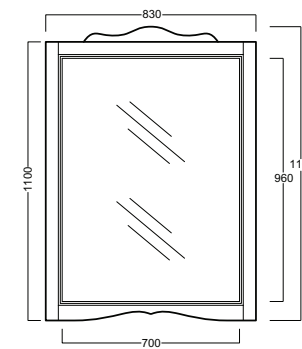
*Mirror cm 83 white/walnut finish**Miroir cm 83 finition blanc/noyer**Spiegel 83 cm. weiß / Nussbaum**Зеркало 83 см цвет белый/орех***F 89**

kg 0,18

Set viti di fissaggio per lavabo

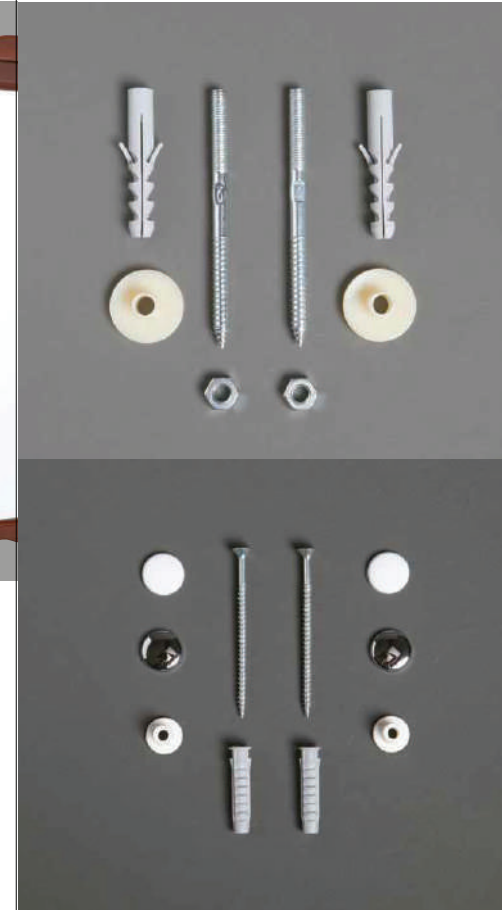
*Set fixing screws for washbasin**Set de vis de fixation pour lavabo**Montageset Waschbecken**Комплект крепежных винтов для раковины***F 84**

kg 3

Coppia staffe di fissaggio per vaso o bidet sospesi

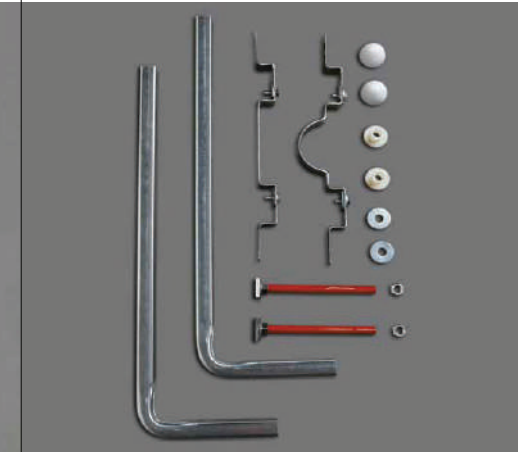
*A pair of brackets for wall hung wc or bidet**Paire d'équerres de fixation pour cuvette ou bidet suspendus**Paar Befestigungshalterungen für Wandklosett oder Wandbidets**Пара крепёжных скоб для подвесных унитаза или биде***F 90**

kg 0,02

Set viti di fissaggio verticali cromo/bianco per vaso o bidet (oro/bronzo su richiesta)

*Set of chrome/white vertical fixing screws for wc or bidet (gold/bronze on demand)**Set de vis de fixation verticales chromé/blanc pour WC ou bidet (doré/bronze sur demande)**Montageset senkrecht weiss/chrom für WC oder Bidet (gold/bronze auf anfrage)**Комплект вертикальных крепежных винтов белый/хром для унитаза или биде (золото/бронза по заявке)*

**D 21**

kg 0,7

Batteria di scarico doppio flusso cromo/oro/bronzo per cassetta monoblocco

*Push button double flush mechanism in chrome/gold/bronze-finish for close coupled cistern*

*Mécanisme de chasse, double chasse, avec bouton chromé/doré/bronze pour réservoir monobloc*

*Spuelung, 2-Mengen-Spuelung mit Taste Chrom/Gold/Bronze für Komplett-Spülkasten*

*Механизм слива с двойным потоком хромированный для моноблочного бачка. Хром/бронза/золото*

**D 13**

kg 0,7

Batteria di scarico ad aria con pulsante cromo/oro/bronzo per cassetta monoblocco

*Push button flush mechanism in chrome/gold/bronze-finish for close coupled cistern*

*Batterie de vidage à air avec bouton chromé/doré/bronze pour réservoir mono bloc*

*Druckluft-Spülgarnitur mit Taste Chrom/Gold/Bronze für Komplett-Spülkasten*

*Пневматический механизм слива с хромированной кнопкой для моноблочного бачка. Хром/бронза/золото*

**D 23**

kg 1,5

Batteria di scarico leva frontale per cassetta AR 812B con tubo in ottone

*Flush mechanism with front lever for low-level cistern AR 812B with plated brass pipe*

*Batterie de vidage commande frontale pour réservoir surélevé AR 812B avec tuyau en laiton*

*Abflussmechanik mit frontseitigem Hebel für wandhängendes Spülkasten AR 812B mit Messingrohr*

*Механизм слива с фронтальной ручкой хром/золото/бронза для среднего бачка AR 812B с трубой из латуни.*

**D 11**

kg 1,5

Batteria di scarico per cassetta a zaino AR 812 con tubo in ottone - cromo/oro/bronzo

*Flush mechanism for low-level cistern AR 812 with plated brass pipe - chrome/gold/bronze-finish*

*Batterie de vidage pour réservoir mi-hauter AR 812 avec tuyau en laiton. Chromé/doré/bronze*

*Spülgarnitur für Halbhoch-Spülkasten AR 812 mit Rohr in Messing Chrom/Gold/Bronze*

*Механизм слива для устанавливаемого сзади бачка AR 812 с латунной трубой. Хром/бронза/золото*

**R 01**

kg 5

Batteria di scarico esterna per cassetta alta AR 802 (R 02 + R 03) cromo/oro/bronzo

*Flush mechanism for high-level cistern AR 802 (R 02 + R 03) chrome/gold/bronze finish*

*Batterie de vidage extérieure pour réservoir haut AR 802 (R 02 + R 03) en chrome/bronze/or*

*Aufputz-Spülgarnitur für hohen Spülkasten AR 802 (R 02 + R 03) in chrom/bronze/gold*

*Наружный механизм слива для высоко бачка AR 802 (R 02 + R 03). Хром/бронза/золото*

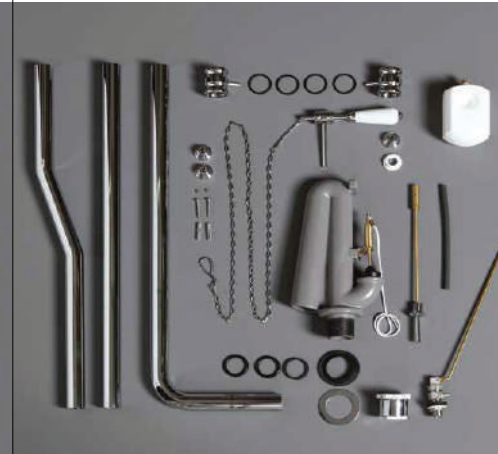
**R 02**

kg 3

Batteria di scarico ad aria con asta, pull in resina bianca, catenella cromo/oro/bronzo

*Flush mechanism with chain & pull in white resin chrome/gold/bronze finish*

*Batterie de vidage à air avec tige, tirette en résine blanche, chaînette en chrome/bronze/or*

*Druckluft-Spülgarnitur mit Stange, Zug in weißem Kunststoff, Kette in chrom/bronze/gold*

*Пневматический механизм слива со штоком, ручкой из синтетической смолы белого цвета, цепочкой. Хром/бронза/золото*

**R 03**

kg 2

Tube di scarico per R 02 cromo/oro/bronzo

*Flush pipe for R 02 chrome/gold/bronze finish*

*Tuyau de vidage pour R 02 en chrome/bronze/or*

*Abflussrohr für R 02 in chrom/bronze/gold*

*Сливная труба для R 02. Хром/бронза/золото*

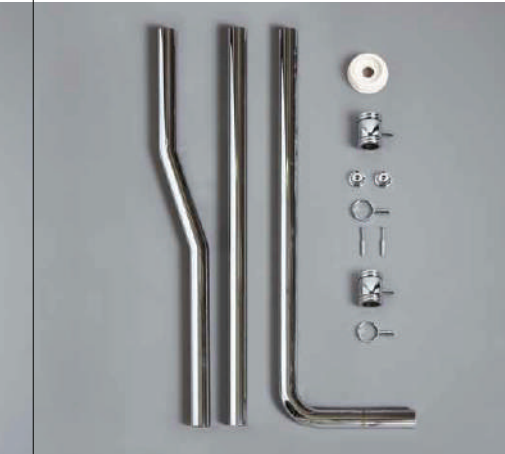
**120006**

kg 0,3

Rubinetto a squadro (cromo/oro/bronzo)

*Angle tap (chrome/gold/bronze)*

*Robinet d'équerre (chrome/doré/bronze)*

*Rechteckiger Hah (chrom/gold/bronze)*

*Угловой кран (хром/золото/бронза)*



# lante

DESIGN: TERRI PECORA

La Nuova Era di Simas si lega al classico: forme morbide, pure e rassicuranti. La limpidezza della ceramica bianca abbinata ai mobili studiati su misura riflette i valori di storie trascorse. Curve dal profilo femminile e pulizia lussuosa che richiamano fasti passati, LANTE COLLECTION è tradizionale e classica, ma si tinge anche di una memoria più recente, una sorta di Art Deco' reinterpretato. Una collezione che esprime la sua completa italianità.

The New Simas Era merges with the classic: soft, pure and reassuring forms. The clarity of white ceramic combined with custom-made products that reflect the values of the past. Curves with feminine and luxurious profiles that recall past glories, LANTE COLLECTION is traditional and classic, but also tinged by a more recent memory, a sort of revised Art Deco. A collection characterised by a strong Italian spirit.

La nouvelle ère de SIMAS se joint au classicisme: formes douces, pures et rassurantes. La limpidité de la céramique blanche unie à des meubles étudiés sur mesure reflet les valeurs d'histoires vécues. Les courbes au profil féminin et la netteté luxueuse rappellent des fastes passés. La Collection LANTE est traditionnelle et classique mais elle est teinte d'une mémoire plus récente une sorte d'Art Déco réinterprété. Une collection qui exprime sa complète italianité.

Das neue Zeitalter der Firma Simas richtet sich nach klassischen weichen Formen, rein und beruhigend. Die Klarheit der weißen Keramik mit maßgeschneiderten Möbeln kombiniert, spiegelt die Werte von gelebter Geschichte wieder. Die Kurven aus dem weichen Profil und die luxuriöse Reinheit, die an die glorreiche Vergangenheit erinnern, ist LANTE Collection nicht nur traditionell und klassisch, sondern nimmt auch auf dem Markt eine neue Interpretation von ART DECO ein. Eine neue Kollektion, die den italienischen Geist ausdrückt.

Новая эра Simas связана с классикой: с мягкими, чистыми и спокойными формами. Чистота белой керамики, сочетающейся со специально разработанной под нее мебелью, отражает ценности ушедших времен. Женственные изгибы профиля и роскошь чистоты напоминают великолепие былых времен. Коллекция LANTE традиционная и классическая, но, в то же время, она окрашена и недавними тенденциями - это своего рода интерпретация Art Deco'. Коллекция, выражающая свое абсолютно итальянское происхождение.



LA 10 70x54x13

LA 11 90x54x13

LA 12 120x54x13



LA 01 38,5x58x40  
LA 02 38,5x53x40

LA 04 38,5x58x40

LA 18 38,5x53x31

LA 19 38,5x53x31



LA 07 42x70,5x84  
LA 08 42x70,5x84  
LA 09 42x20,5x44  
LA 09B 42x20,5x44

LA 28 42x20,5x36,5

LA 28B 42x20,5x36,5

LA 06 42x20x36,5

> **LAS1**  
Specchio 90  
Mirror 90

**LA 12 >**  
Consolle 120  
Console 120

> **LA 04**  
Bidet monoforo  
Single hole bidet

> **LA 09**  
Cassetta per vaso monoblocco  
Cistern for close coupled WC

> **LA 01**  
Vaso monoblocco con scarico pavimento  
Close coupled WC with floor outlet

## la nuova Era del Classico.

The new era of Classic.  
La nouvelle ère du Classique.  
Das neue Zeitalter der Klassik.  
Новая эра классики.

**LA 10**

Lavabo 70. Installazione sospeso, su colonna e su mobile LAM 70  
 Washbasin 70. Wall mounted or mounted on a column LA 03 and on a cabinet LAM 70  
 Lavabo 70. Installation suspendu, sur colonne LA 03 et sur meuble LAM 70  
 Waschtisch 70 cm. Installation wandhängend, oder Stand Säule und Waschtischunterbau LAM 70  
 Раковина 70. Подвесная или установка на пьедестал LA 03 либо на тумбу LAM 70

**LA 03**

Colonna  
 Pedestal  
 Colonne  
 Säule  
 пьедестал

**LAM 70**

Mobile per lavabo finitura bianco lucido,  
 nero lucido e tortora lucido  
 Cabinet for washbasin glossy white/  
 glossy black/glossy dove grey finish  
 Meuble pour lavabo finition blanc brillant/  
 noir brillant /tourterelle brillant  
 Waschtischunterbau für Waschtisch in den  
 Farben Weiß Glänzend / Schwarz Glänzend /  
 Taube Glänzend  
 Тумба под раковину цвет белый глянцевый/  
 черный глянцевый/тортора глянцевый



**ACCESSORI DI COMPLEMENTO**  
**ACCESSORIES AVAILABLE**

**LAS1** Specchio 90  
 90cm mirror

**LA 11**

Consolle 90. Installazione sospesa e su mobile LAM 90  
 Console 90. Wall-mounted and mounted on a cabinet LAM 90  
 Console 90. Installation suspendue et sur meuble LAM 90  
 Konsole 90 cm. Installation wandhängend und Waschtischunterbau LAM 90  
 Консоль 90. Подвесная либо установка на тумбу LAM 90



**ACCESSORI DI COMPLETAMENTO**  
**ACCESSORIES AVAILABLE**

**LAS1** Specchio 90  
 90cm mirror

**LAM 90**

Mobile per consolle finitura  
 bianco lucido, nero lucido e tortora lucido  
 Cabinet for console glossy white / glossy black /  
 glossy dove grey finish  
 Meuble pour console finition blanc brillant /  
 noir brillant / tourterelle brillant  
 Waschtischunterbau für Waschtisch in den Farben  
 Weiß Glänzend / Schwarz Glänzend / Taube Glänzend  
 Тумба под консоль цвет белый глянцевый /  
 черный глянцевый / тортора глянцевый

**LAM 120**

Struttura in legno per consolle finitura  
 bianco lucido, nero lucido e tortora lucido  
 Wooden stand for console glossy white /  
 glossy black / glossy dove grey finish  
 Structure en bois pour console finition  
 blanc brillant / noir brillant / tourterelle brillant  
 Untergestell aus Holz für konsolen Waschtisch in den  
 Farben Weiß Glänzend / Schwarz Glänzend / Taube Glänzend  
 Деревянная структура под консоль цвет  
 белый глянцевый / черный глянцевый / тортора глянцевый

**LA 12**

Consolle 120. Installazione sospesa e su struttura in legno LAM 120  
 Console 120. Wall-mounted and mounted on a wooden stand LAM 120  
 Consolle 120. Installation suspendue et sur structure en bois LAM 120  
 Konsole 120 cm. Installation wandhängend oder auf Waschtischunterbau LAM 120  
 Консоль 120. Подвесная либо установка на деревянную структуру LAM 120



**LA 18**

Vaso sospeso "Rimless"  
 "Rimless" wall hung WC  
 Cuvette suspendue "Rimless"  
 "Rimless" Hänge-WC  
 Унитаз подвесной "Rimless"

**LA 19**

Bidet sospeso monoforo  
 Wall hung bidet with single tap hole  
 Bidet suspendu mono trou  
 Hänge-Bidet, Einloch  
 Биде подвесное с одним отверстием

**LA 01**

Vaso con scarico a pavimento  
 WC with floor outlet  
 Cuvette évacuation verticale  
 WC mit Bodenanschluss  
 Унитаз с вертикальным сливом

**LA 04**

Bidet monoforo  
 Single hole bidet  
 Bidet mono trou  
 Bidet, Einloch  
 Биде

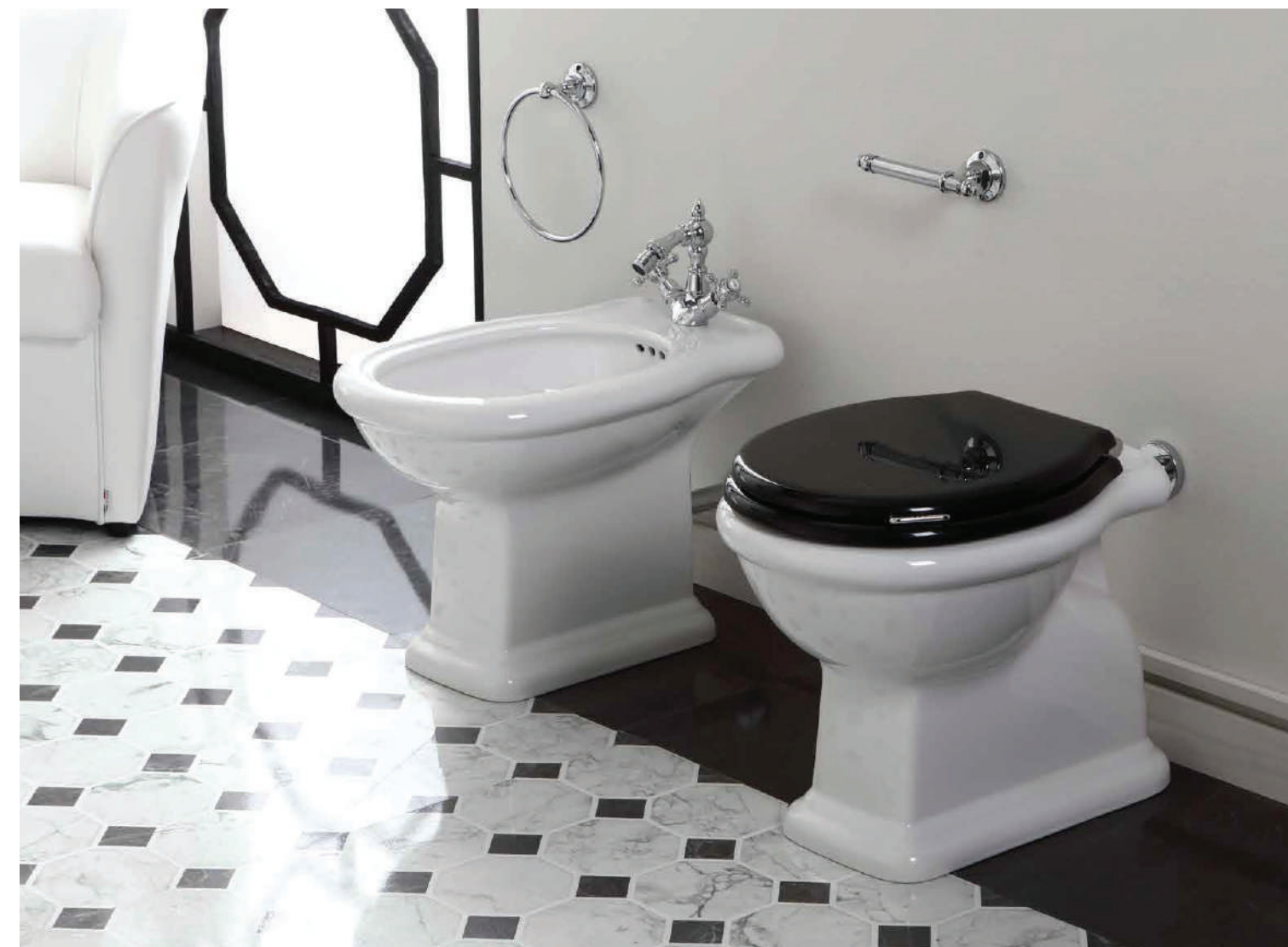

**ACCESSORI DI COMPLEMENTO**  
**ACCESSORIES AVAILABLE**

Coprivaso in poliestere con cerniere cromo **LA 002** o cerniere oro/bronzo **LA 003**  
 Polyester toilet seat with chrome finish hinges **LA 002** or gold/bronze finish hinges **LA 003**  
 Coprivaso in legno color noce con cerniere cromo **LA 004** o cerniere oro/bronzo **LA 005**  
 Wooden toilet seat walnut-finish with chrome-finish hinges **LA 004** or gold/bronze-finish hinges **LA 005**  
 Coprivaso in poliestere con cerniere rallentate cromo **LA 006** o cerniere oro/bronzo **LA 007**  
 Polyester toilet seat with chrome finish soft-closing hinges **LA 006** or gold/bronze finish hinges **LA 007**  
 Coprivaso in legno color noce con cerniere rallentate cromo **LA 008** o cerniere oro/bronzo **LA 009**  
 Wooden toilet seat walnut-finish with chrome-finish soft-closing hinges **LA 008** or gold/bronze finish hinges **LA 009**

**ACCESSORI DI COMPLEMENTO**  
**ACCESSORIES AVAILABLE**

Coprivaso in poliestere con cerniere cromo **LA 002** o cerniere oro/bronzo **LA 003**  
 Polyester toilet seat with chrome finish hinges **LA 002** or gold/bronze finish hinges **LA 003**  
 Coprivaso in legno color noce con cerniere cromo **LA 004** o cerniere oro/bronzo **LA 005**  
 Wooden toilet seat walnut-finish with chrome-finish hinges **LA 004** or gold/bronze-finish hinges **LA 005**  
 Coprivaso in poliestere con cerniere rallentate cromo **LA 006** o cerniere oro/bronzo **LA 007**  
 Polyester toilet seat with chrome finish soft-closing hinges **LA 006** or gold/bronze finish hinges **LA 007**  
 Coprivaso in legno color noce con cerniere rallentate cromo **LA 008** o cerniere oro/bronzo **LA 009**  
 Wooden toilet seat walnut-finish with chrome-finish soft-closing hinges **LA 008** or gold/bronze finish hinges **LA 009**





**LA 07**

Vaso monoblocco con scarico a pavimento  
*Close coupled WC with floor outlet*  
*Cuvette mono bloc évacuation verticale*  
*Monoblock-WC mit Bodenanschluss*  
*Унитаз моноблок с вертикальным сливом*

**LA 09**

Cassetta con coperchio per vaso monoblocco  
*Cistern with lid for close-coupled WC*  
*Réservoir avec couvercle pour WC monobloc*  
*Monoblock Spülkasten für Stand WC*  
*Бачок моноблок с крышкой*

**LA 01**

Vaso con scarico a pavimento  
*WC with floor outlet*  
*Cuvette évacuation verticale*  
*WC mit Bodenanschluss*  
*Унитаз с вертикальным сливом*

**LA 28**

Cassetta a zaino con coperchio,  
 foro laterale per vaso LA 01 e LA 02  
*Low-level cistern with lid,*  
*lateral hole for wc LA 01 and LA 02*  
*Réservoir mi-hauteur avec couvercle,*  
*percement latéral pour WC LA 01 LA 02*  
*Niedrigstand-Spülkasten mit Deckel für*  
*WC LA 01 und LA 02 mit seitlichem Anschluss*  
*Средний бачок с крышкой для унитаза LA 01 и LA 02*

**LA 28B**

Cassetta a zaino con coperchio,  
 foro frontale per vaso LA 01 e LA 02  
*Low-level cistern with lid front hole*  
*for wc LA 01 and LA 02*

**ACCESSORI DI COMPLETAMENTO**  
**ACCESSORIES AVAILABLE**

Coprivaso in poliestere con cerniere cromo **LA 002** o cerniere oro/bronzo **LA 003**  
*Polyester toilet seat with chrome finish hinges LA 002 or gold/bronze finish hinges LA 003*  
 Coprivaso in legno color noce con cerniere cromo **LA 004** o cerniere oro/bronzo **LA 005**  
*Wooden toilet seat walnut-finish with chrome-finish hinges LA 004 or gold/bronze-finish hinges LA 005*  
 Coprivaso in poliestere con cerniere rallentate cromo **LA 006** o cerniere oro/bronzo **LA 007**  
*Polyester toilet seat with chrome finish soft-closing hinges LA 006 or gold/bronze finish hinges LA 007*  
 Coprivaso in legno color noce con cerniere rallentate cromo **LA 008** o cerniere oro/bronzo **LA 009**  
*Wooden toilet seat walnut-finish with chrome-finish soft-closing hinges LA 008 or gold/bronze finish hinges LA 009*  
**D24** Batteria di scarico leva laterale per cassetta monoblocco LA 09B  
*Flush mechanism with side lever for close-coupled cistern LA 09B*  
**LA09** Cassetta con coperchio per vaso monoblocco  
*Cistern with lid for close coupled WC*  
**D 25** Batteria di scarico doppio flusso per cassetta monoblocco LA 09  
*Push button double flush mechanism for close coupled cistern LA 09*

**ACCESSORI DI COMPLETAMENTO**  
**ACCESSORIES AVAILABLE**

Coprivaso in poliestere con cerniere cromo **LA 002** o cerniere oro/bronzo **LA 003**  
*Polyester toilet seat with chrome finish hinges LA 002 or gold/bronze finish hinges LA 003*  
 Coprivaso in legno color noce con cerniere cromo **LA 004** o cerniere oro/bronzo **LA 005**  
*Wooden toilet seat walnut-finish with chrome-finish hinges LA 004 or gold/bronze-finish hinges LA 005*  
 Coprivaso in poliestere con cerniere rallentate cromo **LA 006** o cerniere oro/bronzo **LA 007**  
*Polyester toilet seat with chrome finish soft-closing hinges LA 006 or gold/bronze finish hinges LA 007*  
 Coprivaso in legno color noce con cerniere rallentate cromo **LA 008** o cerniere oro/bronzo **LA 009**  
*Wooden toilet seat walnut-finish with chrome-finish soft-closing hinges LA 008 or gold/bronze finish hinges LA 009*  
**D23** Batteria di scarico leva frontale per cassetta a zaino LA 28B  
*Flush mechanism with front lever for low-level cistern LA 28B*  
**LA28** Cassetta a zaino con coperchio per vaso LA 01 e LA 02  
*Low-level cistern with lid for WC LA 01 and LA 02*  
**D11** Batteria di scarico per cassetta a zaino LA 28  
*Flush mechanism for low-level cistern LA 28*  
**30007** Batteria bidet monoforo  
*One hole bidet mixer*

**LA 01**

Vaso con scarico a pavimento  
 WC with floor outlet  
 Cuvette évacuation verticale  
 WC mit Bodenanschluss  
 Унитаз с вертикальным сливом

**LA 06**

Cassetta con coperchio ad installazione alta per vaso LA 01 e LA 02  
 High-level cistern with lid for wc LA 01 and LA 02  
 Réservoir haut avec couvercle pour cuvette LA 01 LA 02  
 Spülkasten mit Deckel, für Hochinstallation für WC LA 01 und LA 02  
 Высокий бачок с крышкой для унитаза LA 01 и LA 02

**LAMN**

Coppia mensole in ottone laccato bianco per cassetta alta LA 06  
 Pair of shelves in lacquered white brass for high-level cistern LA 06  
 Paire d'équerres en laiton laqué blanc pour réservoir haut LA 06  
 Halterung (Paar) in Weiß lackiert für hochhängenden Spülkasten LA 06  
 Кронштейны (пара) лакированная белая латунь для высокого бачка LA 06

**ACCESSORI DI COMPLETAMENTO  
 ACCESSORIES AVAILABLE**

Coprivaso in poliestere con cerniere cromo **LA 002**  
 o cerniere oro/bronzo **LA 003**  
 Polyester toilet seat with chrome finish hinges LA 002  
 or gold/bronze finish hinges LA 003  
 Coprivaso in legno color noce con cerniere cromo **LA 004**  
 o cerniere oro/bronzo **LA 005**  
 Wooden toilet seat walnut-finish with chrome-finish hinges  
 LA 004 or gold/bronze-finish hinges LA 005  
 Coprivaso in poliestere con cerniere rallentate cromo **LA 006**  
 o cerniere oro/bronzo **LA 007**  
 Polyester toilet seat with chrome finish soft-closing hinges LA 006  
 or gold/bronze finish hinges LA 007  
 Coprivaso in legno color noce con cerniere rallentate cromo  
**LA 008** o cerniere oro/bronzo **LA 009**  
 Wooden toilet seat walnut-finish with chrome-finish soft-closing  
 hinges LA 008 or gold/bronze finish hinges LA 009  
**R 01** Batteria di scarico esterna per cassetta alta (R 02 + R 03)  
 Flush mechanism for high-level cistern (R 02 + R 03)

**LAS1**

Specchio cm 90 finitura bianco lucido, nero lucido e tortora lucido  
 Mirror cm 90 with glossy white/glossy black/glossy dove grey finish  
 Miroir cm 90 finition blanc brillant/ noir brillant /tourterelle brillant  
 Spiegel 90 cm mit Rahmen in den Farben Poliert Weiß / Schwarz Glänzend / Taube Glänzend  
 Зеркало 90 см цвет белый глянцевый/черный глянцевый/тортора глянцевый



**LA 10**

kg 22

Lavabo 70 monoforo (tre fori su richiesta).  
Installazione sospesa

*One-hole washbasin 70 (three holes on demand).  
Wall mounted*

*Lavabo 70 mono trou (trois trous sur demande).  
Installation suspendu*

*Waschtisch 70 cm Einloch (Dreiloch auf Anfrage).  
Installation wandhängend*

*Раковина 70 с одним отверстием (три  
отверстия по запросу). Подвесная установка*

**LA 10 / LA 03**

kg 22/13

Lavabo 70 monoforo (tre fori su richiesta).  
Installazione su colonna LA 03

*One-hole washbasin 70 (three holes on demand).  
Mounted on a column LA 03*

*Lavabo 70 mono trou (trois trous sur demande).  
Installation sur colonne LA 03*

*Waschtisch 70 cm Einloch (Dreiloch auf Anfrage).  
Installation oder Stand Säule*

*Раковина 70 с одним отверстием (три  
отверстия по запросу). Пьедестал LA 03*

**LA 10 / LAM 70**

kg 22/23

Mobile per lavabo LA 10 finitura bianco  
lucido/nero lucido/tortora lucido

*Cabinet for washbasin LA 10 glossy white/glossy  
black/glossy dove grey finish*

*Meuble pour lavabo LA 10 finition  
blanc brillant/noir brillant /tourterelle brillant*

*Waschtischunterbau für Waschtisch LA 10 in  
den Farben Weiß Glänzend / Schwarz Glänzend /  
Taube Glänzend*

*Тумба под раковину LA 10 цвет белый  
глянцевый/черный глянцевый/тортора  
глянцевый*

**LA 11**

kg 27

Consolle 90 monoforo (tre fori su richiesta).  
Installazione sospesa e su mobile LAM 90

*One-hole console 90, (three holes on demand).  
Wall-mounted and mounted on a cabinet LAM 90*

*Console 90 mono trou (trois trous sur demande).  
Installation suspendue et sur meuble LAM 90*

*Konsole 90 cm Einloch (Dreiloch auf  
Anfrage). Installation wandhängend und  
Waschtischunterbau LAM 90*

*Консоль 90 с одним отверстием (три отверстия  
по запросу). Подвесная либо установка на  
тумбу LAM 90*

**LAM 90**

kg 34

Mobile per consolle LA 11 finitura bianco lucido/  
nero lucido/tortora lucido

*Cabinet for console LA 11 glossy white/glossy  
black/glossy dove grey finish*

*Meuble pour console LA 11 finition blanc brillant/  
noir brillant /tourterelle brillant*

*Waschtischunterbau für Waschtisch LA 11 in  
den Farben Weiß Glänzend / Schwarz Glänzend /  
Taube Glänzend.*

*Тумба под консоль LA 11 цвет белый  
глянцевый/черный глянцевый/тортора  
глянцевый*

**LA 12**

kg 12

Consolle 120 monoforo (tre fori su richiesta).  
Installazione sospesa e su struttura in legno  
LAM 120

*One-hole console 120 (three holes on demand).  
Wall-mounted and mounted on a wooden stand  
LAM120*

*Console 120 mono trou (trois trous sur demande).  
Installation suspendue et sur structure en bois  
LAM 120*

*Konsole 120 cm Einloch (Dreiloch auf  
Anfrage). Installation wandhängend oder auf  
Waschtischunterbau LAM 120*

*Консоль 120 с одним отверстием (три  
отверстия по запросу). Подвесная либо  
установка на деревянную структуру LAM 120*

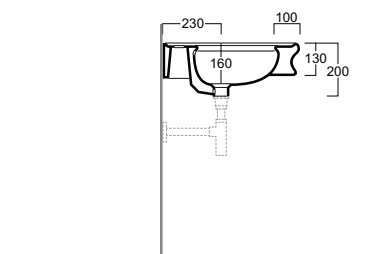
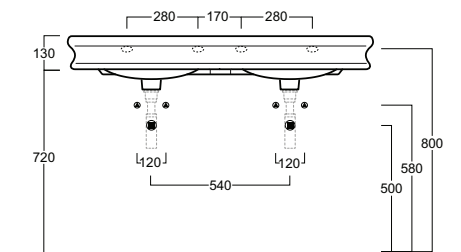
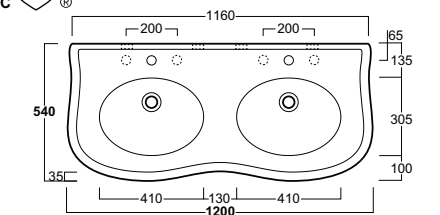
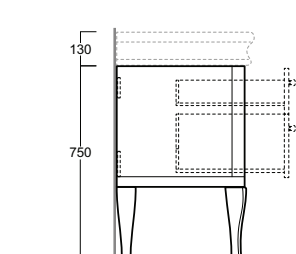
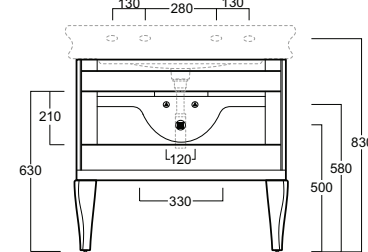
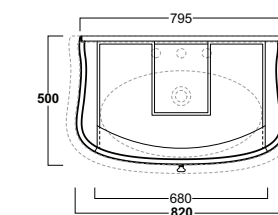
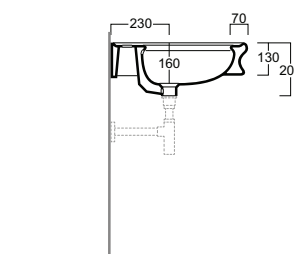
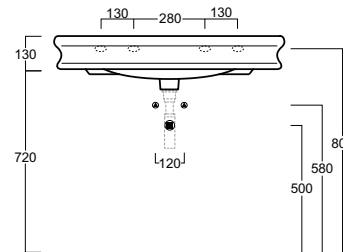
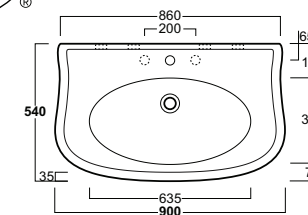
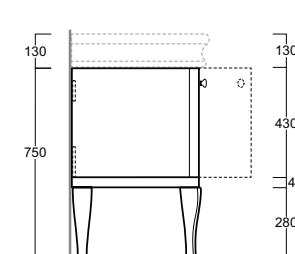
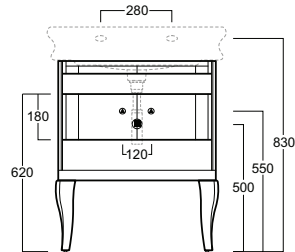
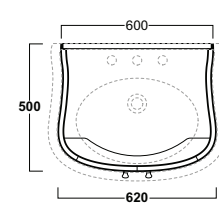
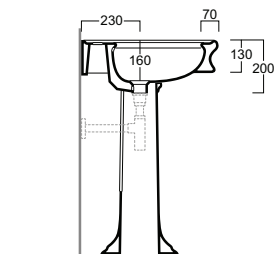
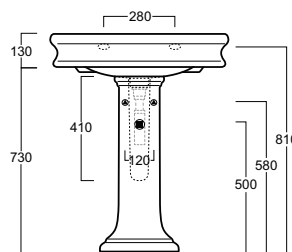
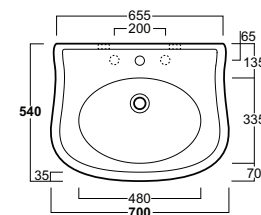
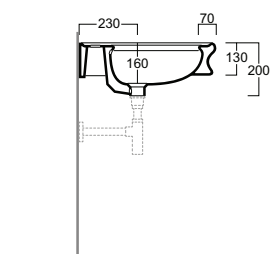
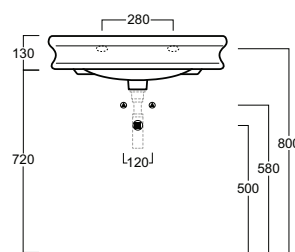
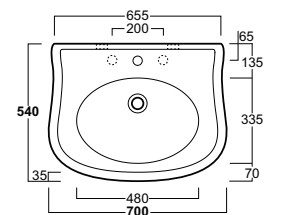

**LAM 120**

kg 7

Struttura in legno per consolle LA 12 finitura  
bianco lucido/nero lucido/tortora lucido

Wooden stand for console LA 12  
glossy white/glossy black/glossy dove grey finish

Structure en bois pour console LA 12 finition  
blanc brillant/noir brillant /tourterelle brillant

Untergestell aus Holz für Konsolen Waschtisch  
LA 12 in den Farben Weiß Glänzend / Schwarz  
Glänzend / Taube Glänzend

Деревянная структура под консоль LA 12 цвет  
белый глянцевый/черный глянцевый/тortora  
глянцевый

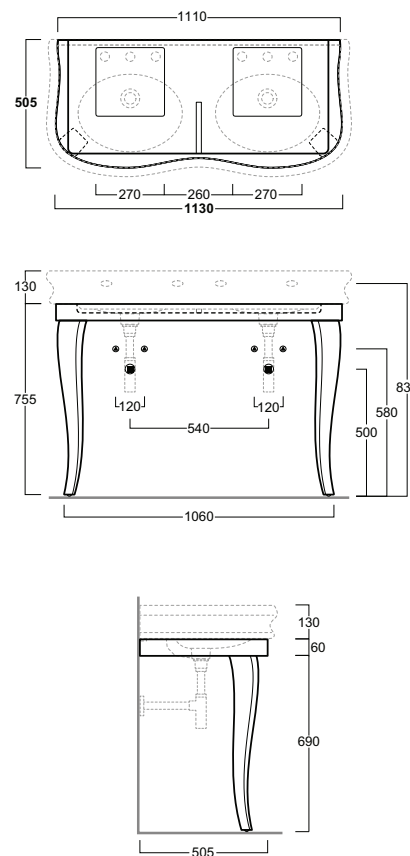
**LA 01**

kg 19

Vaso con scarico a pavimento

WC with floor outlet

Cuvette évacuation verticale

WC mit Bodenanschluss

Унитаз с вертикальным сливом

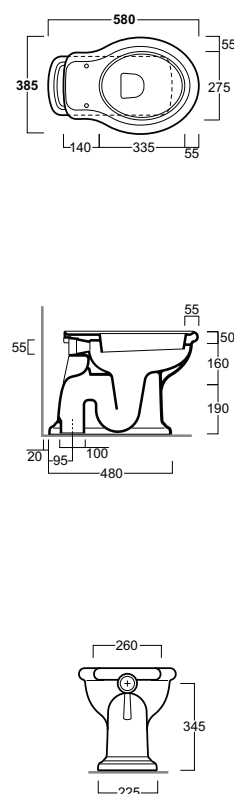
**LA 02**

kg 19

Vaso con scarico a parete

WC with wall outlet

Cuvette évacuation horizontale

WC mit Wandanschluss

Унитаз с горизонтальным сливом

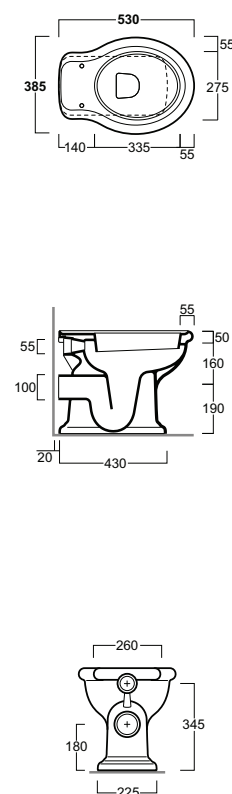
**LA 04**

kg 16

Bidet monoforo (tre fori su richiesta)

Bidet with single tap hole (three holes on demand)

Bidet mono trou (trois trous sur demande)

Bidet, Einloch (Dreiloch auf Anfrage)

Биде с одним отверстием (три отверстия  
по запросу)

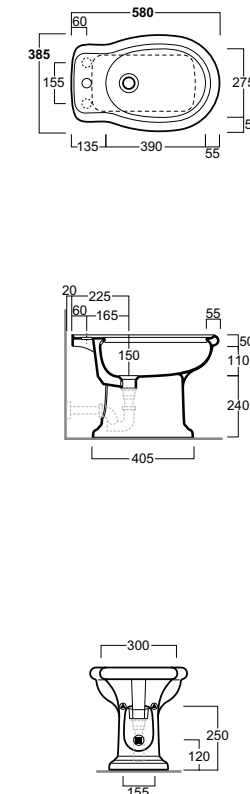
**LA 18**

kg 16,5

Vaso sospeso "Rimless"

"Rimless" wall hung WC

Cuvette suspendue "Rimless"

"Rimless" Hänge-WC

Унитаз подвесной "Rimless"

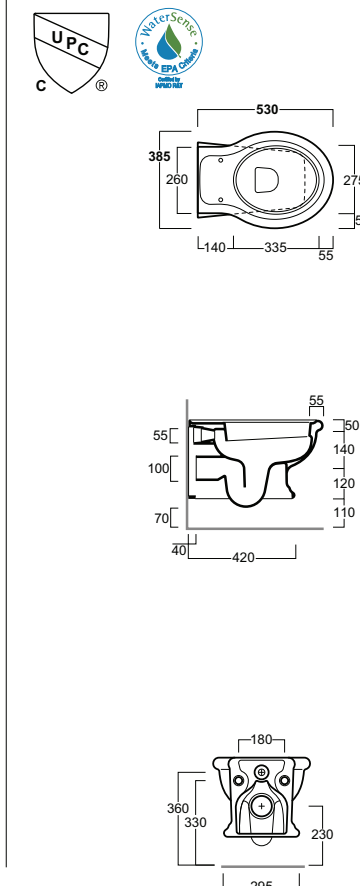
**LA 19**

kg 14,5

Bidet sospeso monoforo

Wall hung bidet with single tap hole

Bidet suspendu mono trou

Hänge-Bidet, Einloch

Биде подвесное с одним отверстием

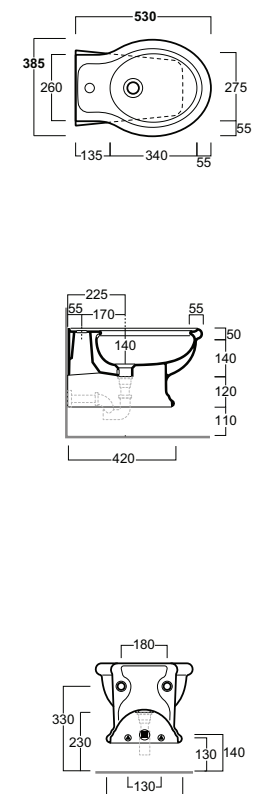

**LA 07 / LA 09**

kg 20/15

Vaso monoblocco con scarico a pavimento e cassetta con coperchio (LA 09)

*Close-coupled toilet bowl with floor outlet and cistern with lid (LA 09)*

*Cuvette mono bloc évacuation verticale réservoir avec un couvercle (LA 09)*

*Monoblock-WC mit Bodenanschluss und Monoblock-Spülkasten (LA 09)*

*Унитаз моноблок с вертикальным сливом и бачок с крышкой (LA 09)*

**LA 08 / LA 09**

kg 20/15

Vaso monoblocco con scarico a parete e cassetta con coperchio (LA 09)

*Close-coupled toilet bowl with wall outlet and cistern with lid (LA 09)*

*Cuvette mono bloc évacuation horizontale réservoir avec un couvercle (LA 09)*

*Monoblock-WC mit Wandanschluss und Monoblock-Spülkasten (LA 09)*

*Унитаз моноблок с горизонтальным сливом и бачок с крышкой (LA 09)*

**LA 07 / LA 09B**

kg 20/15

Vaso monoblocco con scarico a pavimento e cassetta con coperchio, foro laterale

*Close-coupled toilet bowl with floor outlet and cistern with lid, lateral hole*

*Cuvette mono bloc évacuation verticale réservoir avec un couvercle, percement latéral*

*Monoblock-WC mit Bodenanschluss und Monoblock-Spülkasten mit seitlichem Anschluss*

*Унитаз моноблок с вертикальным сливом и бачок с крышкой, отверстие сбоку*

**LA 08 / LA 09B**

kg 20/15

Vaso monoblocco con scarico a parete e cassetta con coperchio, foro laterale

*Close-coupled toilet bowl with wall outlet and cistern with lid, lateral hole*

*Cuvette mono bloc évacuation horizontale réservoir avec un couvercle, percement latéral*

*Monoblock-WC mit Wandanschluss und Monoblock-Spülkasten mit seitlichem Anschluss*

*Унитаз моноблок с горизонтальным сливом и бачок с крышкой, отверстие сбоку*

**LA 01 / LA 28**

kg 12

Cassetta a zaino con coperchio per vaso LA 01

*Low-level cistern with lid for wc LA 01*

*Réservoir mi-hauteur avec couvercle pour cuvette LA 01*

*Niedrigstand-Spülkasten mit Deckel für WC LA 01*

*Средний бачок с крышкой для унитаза LA 01*

**LA 02 / LA 28**

kg 12

Cassetta a zaino con coperchio per vaso LA 02

*Low-level cistern with lid for wc LA 02*

*Réservoir mi-hauteur avec couvercle pour cuvette LA 02*

*Niedrigstand-Spülkasten mit Deckel für WC LA 02*

*Средний бачок с крышкой для унитаза LA 02*

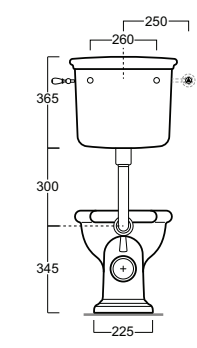
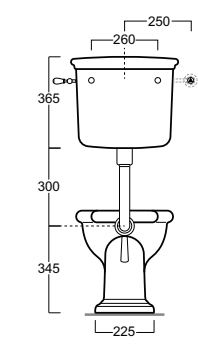
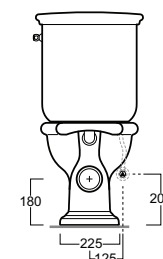
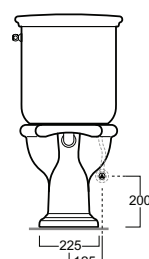
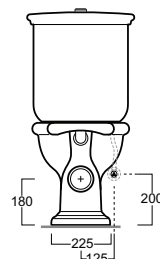
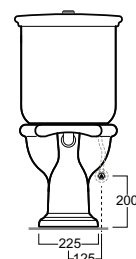
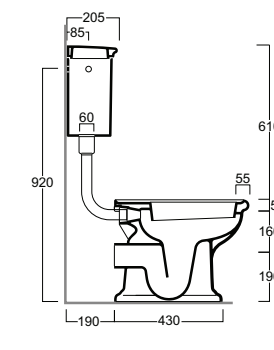
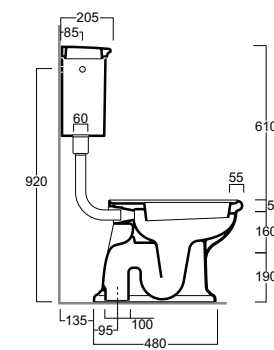
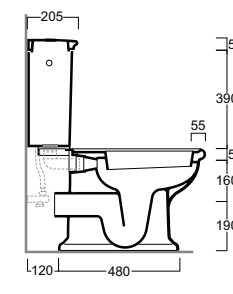
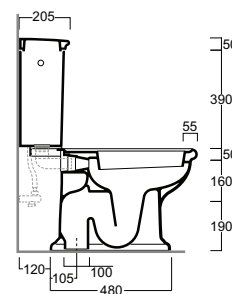
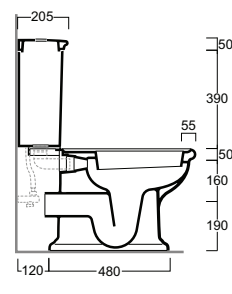
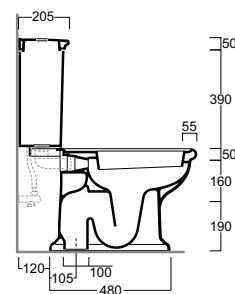
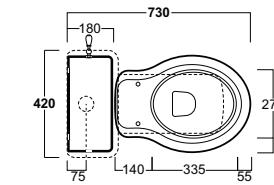
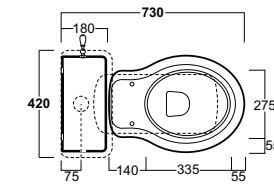
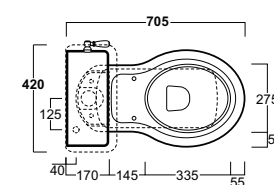
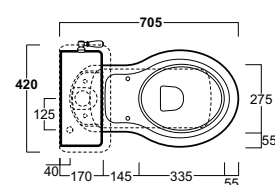
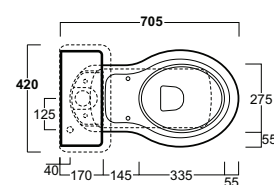
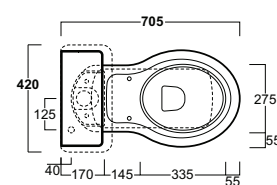

**LA 01 / LA 28B**

kg 12

Cassetta a zaino con coperchio, foro frontale per vaso LA 01

*Low-level cistern with lid front hole for wc LA 01**Réservoir mi-hauteur avec couvercle percement frontal pour WC LA 01**Niedrigstand-Spülkasten mit Deckel für WC LA 01 mit Betätigung von vorne**Средний бачок с крышкой и с фронтальным отверстием, для унитазов LA 01***LA 02 / LA 28B**

kg 12

Cassetta a zaino con coperchio, foro frontale per vaso LA 02

*Low-level cistern with lid front hole for wc LA 02**Réservoir mi-hauteur avec couvercle percement frontal pour WC LA 02**Niedrigstand-Spülkasten mit Deckel für WC LA 02 mit Betätigung von vorne**Средний бачок с крышкой и с фронтальным отверстием, для унитазов LA 02***LA 01 / LA 06**

kg 12

Cassetta con coperchio ad installazione alta per vaso LA 01

*High-level cistern with lid for wc LA 01**Réservoir haut avec couvercle pour cuvette LA 01**Spülkasten mit Deckel, für Hochinstallation für WC LA 01**Высокий бачок с крышкой для унитаза LA 01***LA 02 / LA 06**

kg 12

Cassetta con coperchio ad installazione alta per vaso LA 02

*High-level cistern with lid for wc LA 02**Réservoir haut avec couvercle pour cuvette LA 02**Spülkasten mit Deckel, für Hochinstallation für WC LA 02**Высокий бачок с крышкой для унитаза LA 02***LAMN**

kg 1,6

Coppia mensole in ottone laccato bianco per cassetta alta LA 06

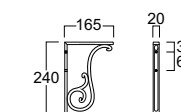
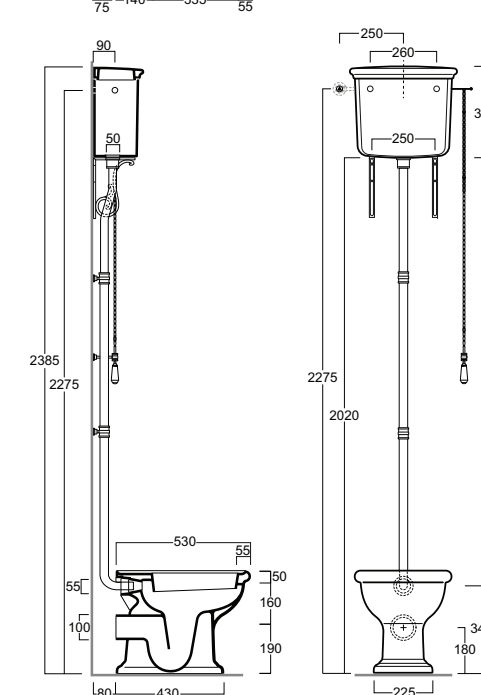
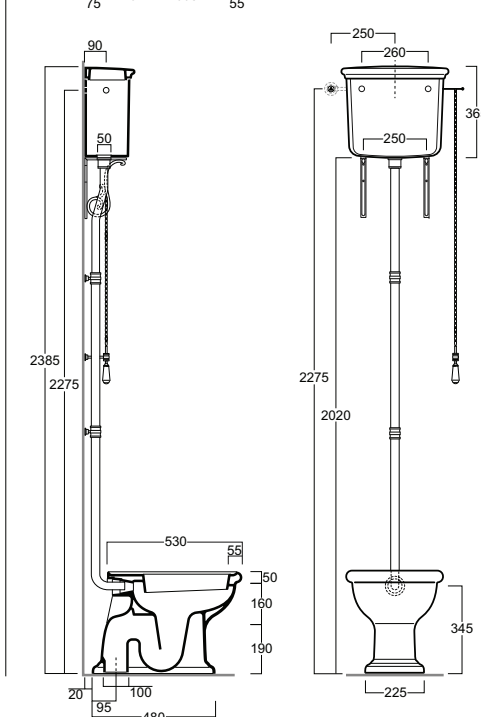
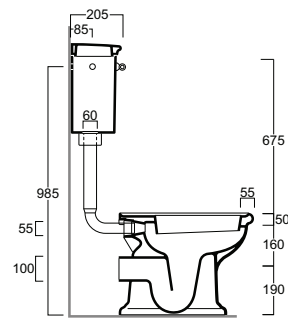
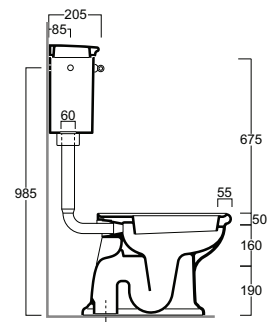
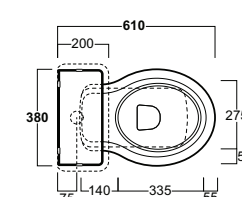
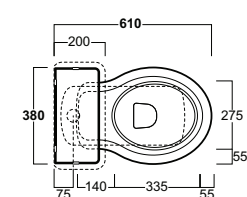
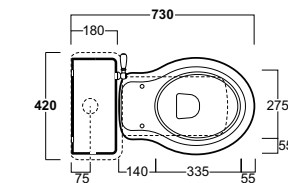
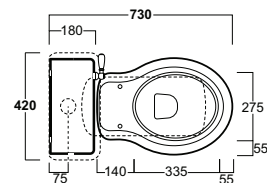
*Pair of shelves in lacquered white brass for high-level cistern LA 06**Paire d'équerres en laiton laqué blanc pour réservoir haut LA 06**Halterung (Paar) in Weiß lackiert für hochhängenden Spülkasten LA 06**Кронштейны (пара) лакированная белая латунь для высокого бачка LA 06*

**LA 002**

kg 3

Coprivaso in poliestere con cerniere cromo  
*Polyester toilet seat with chrome-finish hinges*  
 Abattant en polyester avec charnières chrome  
 WC- Sitz in Polyester mit Chromscharnieren  
 Сиденье, полиэстер, шарниры - хром

**LA 003**

kg 3

Coprivaso in poliestere con cerniere oro/bronzo  
*Polyester toilet seat with gold/bronze-finish hinges*  
 Abattant en polyester avec charnières or/ bronze  
 WC- Sitz in Polyester mit Scharnieren in Gold/Bronze  
 Сиденье, полиэстер, шарниры – золото/бронза

**LA 006**

kg 3

Coprivaso in poliestere con cerniere rallentate cromo  
*Polyester toilet seat with chrome-finish soft-closing hinges*  
 Abattant en polyester avec ralentisseur, charnières chrome  
 WC-Sitz in Polyester mit Chromscharnieren mit Absenkautomatik  
 Сиденье, полиэстер, петли хром, с микролифтом

**LA 007**

kg 3

Coprivaso in poliestere con cerniere rallentate oro/bronzo  
*Polyester toilet seat with gold/bronze-finish soft-closing hinges*  
 Abattant en polyester avec ralentisseur, charnières or/bronze  
 WC-Sitz in Polyester mit Absenkautomatik in gold / bronze  
 Сиденье, полиэстер, петли золото/бронза, с микролифтом

**LA 004**

kg 3

Coprivaso in legno color noce con cerniere cromo  
*Wooden toilet seat walnut-finish with chrome-finish hinges*  
 Abattant en bois couleur noyer avec charnières chrome  
 WC- Sitz und Deckel in Holz, Farbe Nußbaum, mit Chromscharnieren  
 Сиденье, дерево – цвет- орех, шарниры – хром

**LA 005**

kg 3

Coprivaso in legno color noce con cerniere oro/bronzo  
*Wooden toilet seat walnut-finish with gold/bronze finish hinges.*  
 Abattant en bois couleur noyer avec charnières or/bronze  
 WC- Sitz und Deckel in Holz, Farbe Nußbaum, mit Scharnieren in Gold/Bronze  
 Сиденье, дерево – цвет- орех, шарниры – золото/бронза

**LAS1**

kg 7

Specchio cm 90 finitura bianco lucido/nero lucido/tortora lucido

*Mirror 90cm glossy white/glossy black/glossy dove grey finish*

*Miroir cm 90 finition blanc brillant/ noir brillant / tourterelle brillant*

*Spiegel 90 cm mit Rahmen in den Farben Poliert Weiß / Schwarz Glänzend / Taube Glänzend*

*Зеркало 90 см цвет белый глянцевый/черный глянцевый/тортора глянцевый*

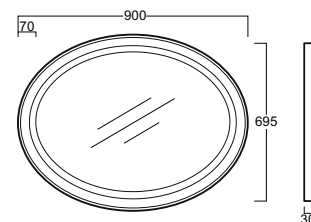
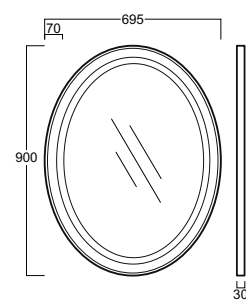
**LA 008**

kg 3

Coprivaso in legno color noce con cerniere rallentate cromo  
*Wooden toilet seat walnut-finish with chrome-finish soft-closing hinges*  
 Abattant en bois avec ralentisseur, charnières chrome  
 WC-Sitz I in Holz „Nuss“ mit Absenkautomatik in chrom  
 Сиденье, дерево, цвет - орех, петли хром, с микролифтом

**LA 009**

kg 3

Coprivaso in legno color noce con cerniere rallentate oro/bronzo  
*Wooden toilet seat walnut-finish with gold/bronze-finish soft-closing hinges*  
 Abattant en bois avec ralentisseur, charnières or/bronze  
 WC-Sitz in Holz „Nuss“ mit Absenkautomatik in gold/bronze  
 Сиденье, дерево, цвет - орех, петли золото/бронза, с микролифтом

**F 89**

kg 0,18

Set viti di fissaggio per lavabo

*Set fixing screws for washbasin*

*Set de vis de fixation pour lavabo*

*Montageset Waschbecken*

*Комплект крепежных винтов для раковины*

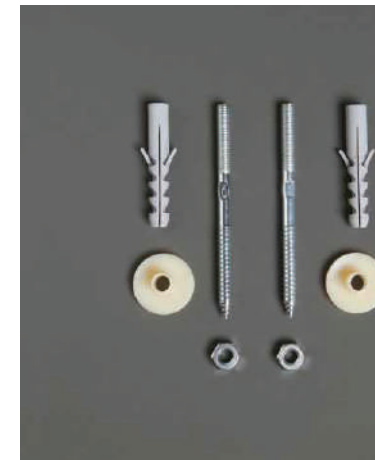
**F 84**

kg 3

Coppia staffe di fissaggio per vaso o bidet sospesi

*A pair of brackets for wall hung wc or bidet*

*Paire d'équerres de fixation pour cuvette ou bidet suspendus*

*Paar Befestigungshalterungen für Wandklosett oder Wandbidets*

*Пара крепёжных скоб для подвесных унитаза или биде*

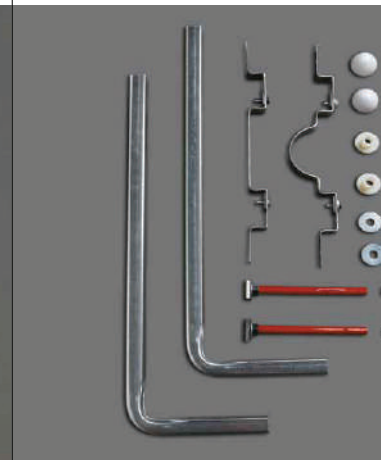
**D 25**

kg 1

Batteria di scarico doppio flusso cromo/oro/bronzo per cassetta monoblocco LA 09

*Push button double flush mechanism in chrome/ gold/bronze-finish for close coupled cistern LA 09*

*Batterie de vidage d'eau/double flux, avec bouton chromé/doré/bronze pour réservoir monobloc LA 09*

*Spuelung, 2-Mengen-Spuelung mit Taste Chrom/ Gold/Bronze für Komplett-Spülkasten LA 09*

*Механизм слива с двойным потоком хромированный для бачка моноблок LA 09 Хром/бронза/золото*



**D 24**

kg 1

Batteria di scarico leva laterale per cassetta monoblocco LA 09B cromo/oro/bronzo

*Flush mechanism with side lever for close-coupled cistern LA 09B chrome/gold/bronze*

*Batterie de vidage levier latéral pour réservoir monobloc LA 09B chrome/or/bronze*

*Druckluft-Spülgarnitur seitlich für Komplett-Spülkasten LA 09B*

*Механизм слива с фронтальной ручкой для бачка моноблок LA 09B хром/золото/бронза*

**D 23**

kg 1,5

Batteria di scarico leva frontale cromo/oro/bronzo per cassetta LA 28B con tubo in ottone

*Flush mechanism with front lever, chrome/gold/bronze, for low-level cistern LA 28B with brass pipe*

*Batterie de vidage levier frontal chrome/or/bronze pour réservoir mi-hauteur LA 28B avec tuyau en laiton*

*Spülgarnitur Betätigung von Vorne Für Halbhoch Spülkasten LA 28B mit Rohr in Messing in den Farben chrom / Gold / Bronze*

*Механизм слива с фронтальной ручкой хром/золото/бронза для среднего бачка LA 28B с трубой из латуни*

**D 11**

kg 1,5

Batteria di scarico per cassetta a zaino LA 28 con tubo in ottone cromo/oro/bronzo

*Flush mechanism for low-level cistern LA 28 with plated brass pipe - chrome/gold/bronze-finish*

*Batterie de vidage pour réservoir mi-hauter LA 28 avec tuyau en laiton. Chromé/doré/bronze*

*Spülgarnitur für Halbhoch-Spülkasten LA 28 mit Rohr in Messing Chrom/Gold/Bronze*

*Механизм слива для среднего бачка LA 28 с латунной трубой. Хром/бронза/золото*

**R 01**

kg 5

Batteria di scarico esterna per cassetta alta LA 06 (R 02 + R 03) cromo/oro/bronzo

*Flush mechanism for high-level cistern LA 06 (R 02 + R 03) chrome/gold/bronze finish*

*Batterie de vidage extérieure pour réservoir haut LA 06 (R 02 + R 03) en chrome/bronze/or*

*Aufputz-Spülgarnitur für hohen Spülkasten LA 06 (R 02 + R 03) in chrom/bronze/gold*

*Наружный механизм слива для высоко бачка LA 06 (R 02 + R 03). Хром/бронза/золото*

**R 02**

kg 3

Batteria di scarico ad aria con asta, pull in resina bianca, catenella cromo/oro/bronzo

*Flush mechanism with chain & pull in white resin chrome/gold/bronze finish*

*Batterie de vidage à air avec tige, tirette en résine blanche, chaînette en chrome/bronze/or*

*Druckluft-Spülgarnitur mit Stange, Zug in weißem Kunststoff, Kette in chrom/bronze/gold*

*Пневматический механизм слива со штоком, ручкой из синтетической смолы белого цвета, цепочкой. Хром/бронза/золото*

**R 03**

kg 1

Tubo di scarico per R 02 cromo/oro/bronzo

*Flush pipe for R 02 chrome/gold/bronze finish*

*Tuyau de vidage pour R 02 en chrome/bronze/or*

*Abflussrohr für R 02 in chrom/bronze/gold*

*Сливная труба для R 02. Хром/бронза/золото*





# londra

DESIGN: UFFICIO TECNICO

Le linee giocano nel classico con luce, freschezza, pulizia. Una collezione semplicemente 'di famiglia'. Addirittura stilè. Un evergreen decisamente di successo.

Classically playful forms- light, clean and fresh. A family collection. Even more - completely stylised. Timeless and totally successful.

Les lignes jouent dans le classique avec lumière, fraîcheur, propreté. Une collection simplement de 'famille'. Avec du style. Un evergreen de succès décisif.

Eine klassische Linienführung. Diese familiäre Kollektion verkörpert Licht, Frische und Reinheit. Ein besonderer, zeitloser Stil. Ein erfolgreicher Evergreen.

Классические формы - игра света, свежесть, чистота. Определенный строгий стиль. Вечно актуальный дизайн.



LO 944 38x31x17



LO 914 58x45x15,5



LO 924 68x51x15,5



LO 934 105x57x10



LO 901 36,5x50,5x40  
LO 911 36,5x46x40



LO 923 34x53x40



LO 918 36,5x51,5x33



LO 919 34x50,5x33



LO 921 39,5x67,5x85  
LO 931 39,5x67,5x85  
LO 922 39,5x20x45



LO 912 43x20x40



LO 902 43x20x39

un classico dal sapore  
moderno, definito  
da linee pulite.

A classic with a modern flavour, defined by clean lines.  
Un classique de la saveur moderne, défini par des lignes épurées.  
Klassisch mit einem Hauch Moderne, durch saubere und reine Linien bestimmt.  
Классика в современном прочтении, чистые линии.

< LO 902  
Cassetta alta  
High-level cistern

> LO 901  
Vaso con scarico pavimento  
Wc with floor outlet

< LO 923  
Bidet con brida  
Bidet with rim

< LO 924  
Lavabo 68  
Washbasin 68

< LO 905  
Colonna  
Column



**GB 001**

Gamba in ceramica per consolle LO 934  
 Ceramic leg for console LO 934  
 Pied en céramique pour consolle LO 934  
 Stützfuß in Keramik für Konsolle LO 934  
 Керамическая нога для консолей LO 934

**LO 934**

Consolle 105 monoforo. Installazione su gambe o mensole  
 Single hole console 105. To be mounted on legs or brackets  
 Consolle 105 mono trou. Installation sur pieds ou étagères  
 Konsolle 105, Einloch. Installation auf Stützfuß oder Halterung  
 Консоль 105 с одним отверстием и двумя намеченными  
 под смеситель на 3 отверстия

**ACCESSORI DI COMPLETAMENTO**  
**ACCESSORIES AVAILABLE**

GB 001 Gamba in ceramica  
 Ceramic leg  
 MNSLEN Mensola in ceramica  
 Ceramic bracket  
 MNSAR Coppia mensole in metallo  
 A set of metal brackets

**LO 924**

Lavabo 68 sospeso o su colonna  
 Washbasin 68 wall hung or on pedestal  
 Lavabo 68 suspendu ou sur colonne  
 Waschbecken 68 wandhängend oder auf Säule  
 Раковина 68 с одним отверстием подвесная либо на пьедестале

**LO 905**

Colonna  
 Pedestal

**ACCESSORI DI COMPLETAMENTO**  
**ACCESSORIES AVAILABLE**

LO 905 Colonna  
 Pedestal  
 MNSAR Coppia mensole in metallo laccato bianco  
 A set of white lacquered metal brackets

**LO 914**

Lavabo 58 su colonna  
 Washbasin 58 on pedestal  
 Lavabo 58 sur colonne  
 Waschtisch 58 auf Säule  
 Умывальник 58 на колонне

**LO 915**

Colonna  
 Pedestal  
 Colonne  
 Säule  
 Колонне

**LO 944**

Lavamani 38 monoforo sospeso (tre fori su richiesta)  
 Single hole wall hung wash-hand basin 38 (three holes on demand)  
 Lave mains 38 mono trou suspendu (trois trous sur demande)  
 Einloch Handwaschbecken 38 frei eingesetzt (Dreiloch auf Anfrage)  
 Рукомойник 38 с одним отверстием, подвесной (три отверстия по запросу).



ACCESSORI DI COMPLEMENTAMENTO  
 ACCESSORIES AVAILABLE

LO 915 Colonna  
 Pedestal

**LO 923**

Bidet monoforo con brida  
 Single hole bidet with rim supply  
 Bidet mono trou avec bride  
 Einloch-Bidet mit Klemmstück  
 Биде с одним отверстием с зажимом

**LO 901**

Vaso con scarico a pavimento  
 Wc with floor outlet  
 Cuvette avec décharge au sol  
 WC mit Bodenanschluss  
 Унитаз с вертикальным сливом

**LO 923**

Bidet monoforo con brida  
 Single hole bidet with rim supply  
 Bidet mono trou avec bride  
 Einloch-Bidet mit Klemmstück  
 Биде с одним отверстием с зажимом



**ACCESSORI DI COMPLETAMENTO**  
**ACCESSORIES AVAILABLE**

Coprivaso in poliestere con cerniere cromo **LO 002** o cerniere oro/bronzo **LO 003**  
 Polyester toilet seat with chrome finish hinges LO 002 or gold/bronze finish hinges LO 003  
 Coprivaso in legno color noce con cerniere cromo **LO 004** o cerniere oro/bronzo **LO 005**  
 Wooden toilet seat walnut-finish with chrome-finish hinges LO 004 or gold/bronze-finish hinges LO 005  
 Coprivaso in poliestere con cerniere rallentate cromo **LO 006** o cerniere oro/bronzo **LO 007**  
 Polyester toilet seat with chrome finish soft-closing hinges LO 006 or gold/bronze finish hinges LO 007  
 Coprivaso in legno color noce con cerniere rallentate cromo **LO 008** o cerniere oro/bronzo **LO 009**  
 Wooden toilet seat walnut-finish with chrome-finish soft-closing hinges LO 008 or gold/bronze finish hinges LO 009

**LO 901**

Vaso con scarico a pavimento  
 Wc with floor outlet  
 Cuvette avec décharge au sol  
 WC mit Bodenanschluss  
 Унитаз с вертикальным сливом

**LO 912**

Cassetta a zaino con coperchio  
 per vaso LO 901 e LO 911  
 Low-level cistern with lid for WC  
 LO 901 and LO 911  
 Réservoir mi-hauteur avec couvercle  
 pour cuvette LO 901 et LO 911  
 Niedrigstand-Spülkasten mit Deckel für  
 WC LO 901 und LO 911  
 Устанавливаемый сзади бачок с крышкой  
 для унитаза LO 901 и LO 911



**ACCESSORI DI COMPLETAMENTO**  
**ACCESSORIES AVAILABLE**

Coprivaso in poliestere con cerniere cromo **LO 002** o cerniere oro/bronzo **LO 003**  
 Polyester toilet seat with chrome finish hinges LO 002 or gold/bronze finish hinges LO 003  
 Coprivaso in legno color noce con cerniere cromo **LO 004** o cerniere oro/bronzo **LO 005**  
 Wooden toilet seat walnut-finish with chrome-finish hinges LO 004 or gold/bronze-finish hinges LO 005  
 Coprivaso in poliestere con cerniere rallentate cromo **LO 006** o cerniere oro/bronzo **LO 007**  
 Polyester toilet seat with chrome finish soft-closing hinges LO 006 or gold/bronze finish hinges LO 007  
 Coprivaso in legno color noce con cerniere rallentate cromo **LO 008** o cerniere oro/bronzo **LO 009**  
 Wooden toilet seat walnut-finish with chrome-finish soft-closing hinges LO 008 or gold/bronze finish hinges LO 009

**LO 902**

Cassetta con coperchio ad installazione alta per vaso LO 901 e LO 911  
 High-level cistern with lid for WC LO 901 and LO 911  
 Réservoir avec couvercle à installation haute pour cuvette LO 901 et LO 911  
 Spülkasten mit Deckel, für Hochinstallation für WC LO 901 und LO 911  
 Высокий бачок с крышкой для унитаза LO 901 и LO 911



**LO 919**

Bidet monoforo sospeso  
 Wall hung bidet with single tap hole  
 Bidet mono trou suspendu  
 Hänge-Bidet, Einloch  
 Биде подвесное с одним отверстием

**LO 918**

Vaso sospeso  
 Wall Hung WC  
 Cuvette suspendue  
 Hänge-WC  
 Унитаз подвесной

**ACCESSORI DI COMPLETAMENTO**  
**ACCESSORIES AVAILABLE**

**LO 002S** Coprivaso in poliestere con cerniere cromo  
 Polyester toilet seat with chrome-finish hinges  
**LO 003S** Coprivaso in poliestere con cerniere oro/bronzo  
 Polyester toilet seat with gold/bronze-finish hinges  
**LO 004S** Coprivaso in legno color noce con cerniere cromo  
 Wooden toilet seat walnut-finish with chrome-finish hinges  
**LO 005S** Coprivaso in legno color noce con cerniere oro/bronzo  
 Wooden toilet seat walnut-finish with gold/bronze-finish hinges

**LO 006S** Coprivaso in poliestere con cerniere rallentate cromo  
 Polyester toilet seat with chrome-finish soft-closing hinges  
**LO 007S** Coprivaso in poliestere con cerniere rallentate oro/bronzo  
 Polyester toilet seat with gold/bronze-finish soft-closing hinges  
**LO 008S** Coprivaso in legno color noce con cerniere rallentate cromo  
 Wooden toilet seat walnut finish with chrome-finish soft-closing hinges  
**LO 009S** Coprivaso in legno color noce con cerniere rallentate oro/bronzo  
 Wooden toilet seat walnut finish with gold/bronze-finish soft-closing hinges

**LO 921**

Vaso monoblocco con scarico a pavimento  
 Close coupled wc with floor outlet  
 Cuvette mono bloc avec décharge au sol  
 Monoblock WC mit Bodenabfluss  
 Моноблочный унитаз со сливом в полу

**LO 922**

Cassetta con coperchio per vaso monoblocco  
 Cistern with lid for close coupled wc  
 Réservoir avec couvercle pour cuvette monobloc  
 Spülkasten mit Deckel für Monoblock WC  
 Бачок сливной с крышкой для моноблочного унитаза

**LO 931**

Vaso monoblocco con scarico a parete  
 Close coupled wc with wall outlet

**ACCESSORI DI COMPLETAMENTO**  
**ACCESSORIES AVAILABLE**

Coprivaso in poliestere con cerniere cromo **LO 002** o cerniere oro/bronzo **LO 003**  
 Polyester toilet seat with chrome finish hinges LO 002 or gold/bronze finish hinges LO 003  
 Coprivaso in legno color noce con cerniere cromo **LO 004** o cerniere oro/bronzo **LO 005**  
 Wooden toilet seat walnut-finish with chrome-finish hinges LO 004 or gold/bronze-finish hinges LO 005  
 Coprivaso in poliestere con cerniere rallentate cromo **LO 006** o cerniere oro/bronzo **LO 007**  
 Polyester toilet seat with chrome finish soft-closing hinges LO 006 or gold/bronze finish hinges LO 007  
 Coprivaso in legno color noce con cerniere rallentate cromo **LO 008** o cerniere oro/bronzo **LO 009**  
 Wooden toilet seat walnut-finish with chrome-finish soft-closing hinges LO 008 or gold/bronze finish hinges LO 009  
**D13** Batteria di scarico ad aria per cassetta monoblocco  
 Push button flush mechanism for close coupled cistern  
**D21** Batteria di scarico ad aria doppio flusso per cassetta monoblocco  
 Push button double flush mechanism for close coupled cistern



**LO 914 / LO 915**

kg 15/10

Lavabo 58 monoforo predisposto per rubinetteria a tre fori. Installazione su colonna (LO 915)

*Washbasin 58 with single tap hole pre-punched for three tap holes. To be mounted on pedestal (LO 915)*

*Lavabo 58 mono trou prédisposé pour robinetterie à trois trous. Installation sur colonne (LO 915)*

*Wachbecken 58, Einloch, für Dreilocharmatur vorgesehen. Installation auf Säule (LO 915)*

*Раковина 58 с одним отверстием и двумя намеченными под смеситель на 3 отверстия. Установка на пьедестал (LO 915)*

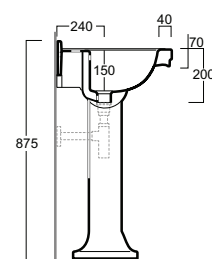
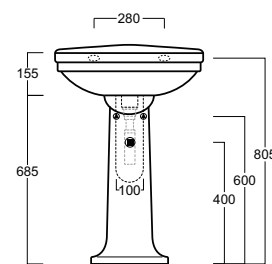
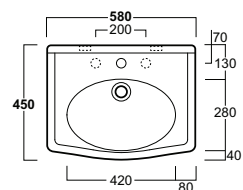
**LO 924 / LO 905**

kg 19/12

Lavabo 68 monoforo predisposto per rubinetteria a tre fori. Installazione su colonna (LO 905)

*Washbasin 68 with single tap hole pre-punched for three tap holes. To be mounted on pedestal (LO 905)*

*Lavabo 68 mono trou prédisposé pour robinetterie à trois trous. Installation sur colonne (LO 905)*

*Wachbecken, Einloch, für Dreilocharmatur vorgesehen. Installation auf Säule (LO 905)*

*Раковина с одним отверстием и двумя намеченными под смеситель на 3 отверстия. Установка на пьедестал (LO 905)*

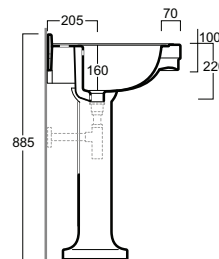
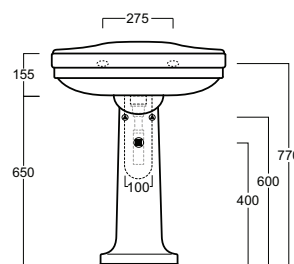
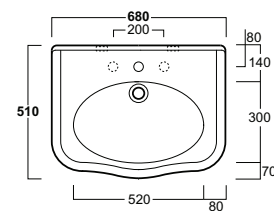
**LO 934**

kg 31

Consolle 105 monoforo predisposta per rubinetteria a tre fori. Installazione su gambe o mensole

*Single hole console 105 pre-punched for three tap holes. To be mounted on legs or brackets*

*Console 105 mono trou prédisposé pour robinetterie à trois trous. Installation sur pieds ou étagères*

*Konsole 105, Einloch, für Dreilocharmatur vorgesehen. Installation auf Stützfuß oder Halterung*

*Консоль 105 с одним отверстием и двумя намеченными под смеситель на 3 отверстия. Установка на керамические ноги или кронштейны*

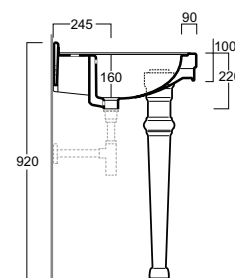
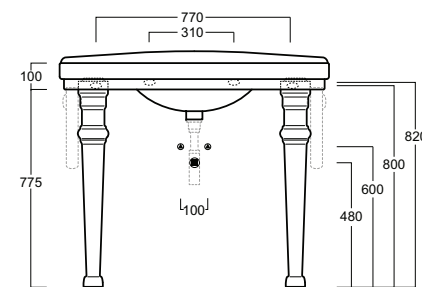
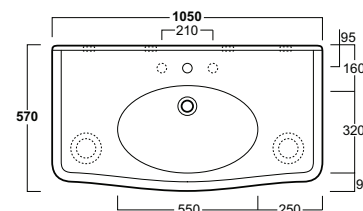
**GB 001**

kg 4

Gamba in ceramica per consolle LO 934. Necessarie due unità per installazione consolle

*Ceramic leg for console LO 934. Two pieces are needed for the installation*

*Pied en céramique pour console LO 934. Deux pièces sont nécessaires pour l'installation de la console*

*Stützfuß in Keramik für Konsole LO 934. Es werden für Installation Konsole zwei Einheiten benötigt*

*Керамическая нога для консоли LO 934. Нужно 2 шт. для установки консоли*

**MNSLEN**

kg 2

Mensola in ceramica per consolle LO 934. Necessarie due unità per installazione consolle

*Ceramic bracket for console LO 934. Two pieces are needed for the installation*

*Etagère en céramique pour console LO 934. Deux pièces sont nécessaires pour l'installation de la console*

*Halterung in Keramik für Konsole LO 934. Es werden für Installation Konsole zwei Einheiten benötigt*

*Керамический кронштейн для консоли LO 934. Нужно 2 шт. для установки консоли*

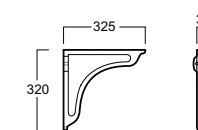
**MNSAR**

kg 3,2

Coppia mensole in metallo laccato bianco per consolle LO 934 e lavabo LO 924

*A set of white lacquered metal brackets for console LO 934 and washbasin LO 924*

*Etagère laqué blanc pour console LO 934 et lavabos LO 924*

*Halterung, weiß lackiert für Konsole LO 934 und Waschbecken LO 924*

*Кронштейн, материал – лакированная латунь белого цвета. Для консолей LO 934 - LO 924*

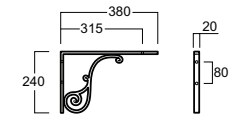
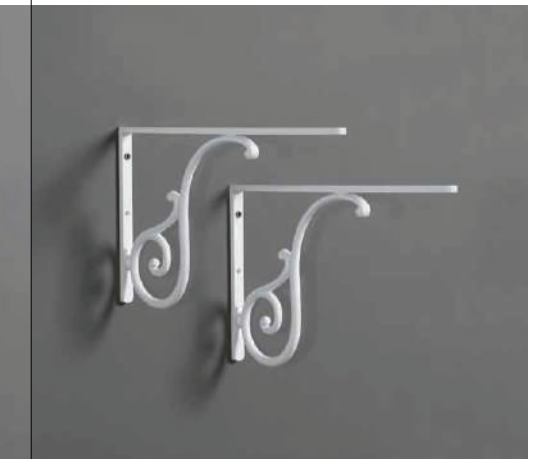



**LO 944**

kg 7

Lavamani 38 monoforo sospeso

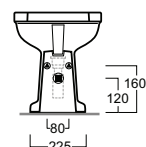
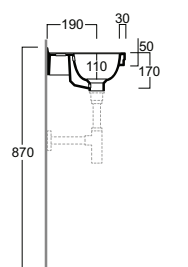
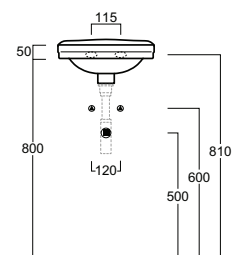
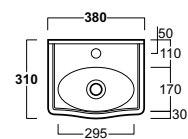
*Single hole wall hung wash-hand basin 38**Lave mains 38 mono trou suspendu**Einloch Handwaschbecken 38 frei eingesetzt**Рукомойник 38 с одним отверстием, подвесной***LO 923**

kg 14

Bidet monoforo con brida predisposto per rubinetteria a tre fori

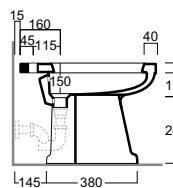
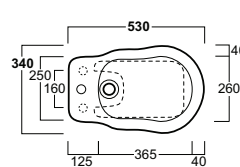
*Single hole bidet with rim supply pre-punched for three tap holes**Bidet mono trou avec bride prédisposé pour robinetterie à trois trou**Bidet, Einloch, mit Schelle für Dreilocharmatur**Биде с желобом с одним отверстием и двумя намеченными под смеситель на 3 отверстия***LO 901**

kg 16

Vaso con scarico a pavimento

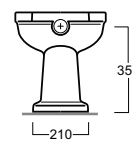
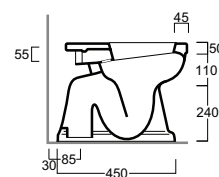
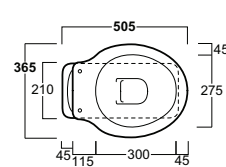
*WC with floor outlet**Cuvette avec décharge au sol**WC mit Bodenanschluss**Унитаз с вертикальным сливом***LO 911**

kg 16

Vaso con scarico a parete

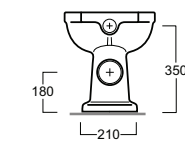
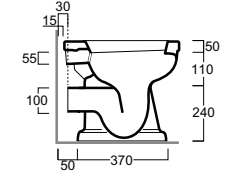
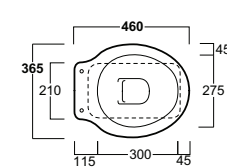
*WC with wall outlet**Cuvette avec décharge au mur**WC mit Wandanschluss**Унитаз с горизонтальным сливом***LO 921 / LO 922**

kg 18

Vaso monoblocco con scarico a pavimento e cassetta con coperchio (LO 922)

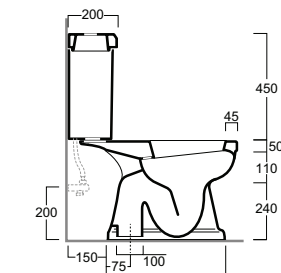
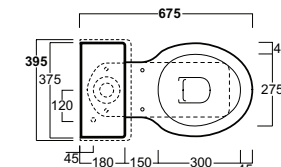
*Close coupled WC with floor outlet and cistern with lid (LO 922)**Cuvette mono bloc avec décharge au sol et réservoir avec couvercle (LO 922)**Monoblock-WC mit Bodenanschluss und Monoblock-Spülkasten (LO 922)**Унитаз моноблок с вертикальным сливом и бачок с крышкой (LO 922)***LO 931 / LO 922**

kg 18

Vaso monoblocco con scarico a parete e cassetta con coperchio (LO 922)

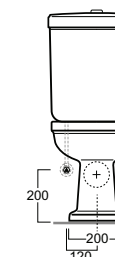
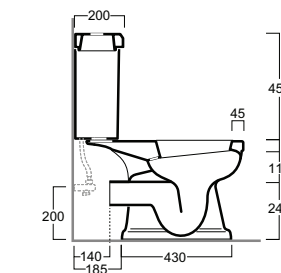
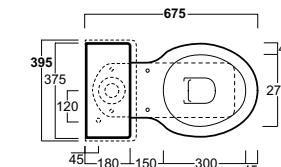
*Close coupled WC with wall outlet and cistern with lid (LO 922)**Cuvette mono bloc avec décharge à mur et réservoir avec couvercle (LO 922)**Monoblock-WC mit Wandanschluss und Monoblock-Spülkasten (LO 922)**Унитаз моноблок с горизонтальным сливом и бачок с крышкой (LO 922)*

**LO 902 / LO 901**

kg 14

Cassetta con coperchio ad installazione alta per vaso LO 901

*High-level cistern with lid for WC LO 901**Réservoir avec couvercle à installation haute pour cuvette LO 901**Spülkasten mit Deckel, für Hochinstallation für WC LO 901**Высокий бачок с крышкой для унитаза LO 901***LO 902 / LO 911**

kg 14

Cassetta con coperchio ad installazione alta per vaso LO 911

*High-level cistern with lid for WC LO 911**Réservoir avec couvercle à installation haute pour cuvette LO 911**Spülkasten mit Deckel, für Hochinstallation für WC LO 911**Высокий бачок с крышкой для унитаза LO 911***LO 912 / LO 901**

kg 16

Cassetta a zaino con coperchio per vaso LO 901

*Low-level cistern with lid for WC LO 901**Réservoir mi-hauteur avec couvercle pour cuvette LO 901**Niedrigstand-Spülkasten mit Deckel für WC LO 901**Устанавливаемый сзади бачок с крышкой для унитаза LO 901***LO 912 / LO 911**

kg 16

Cassetta a zaino con coperchio per vaso LO 911

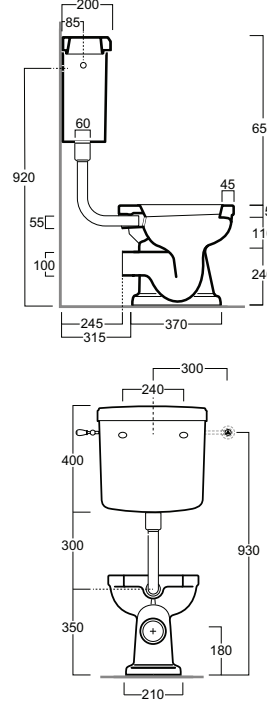
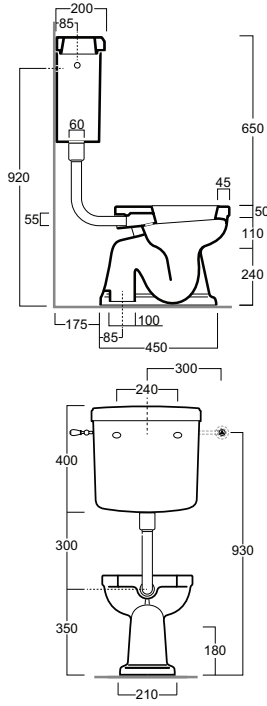
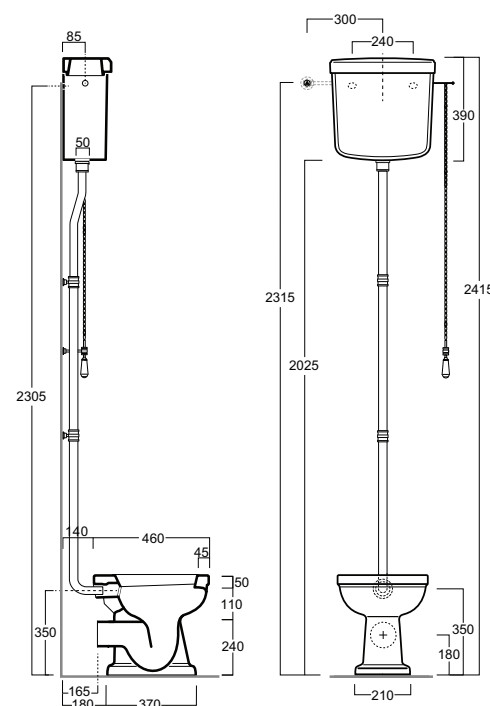
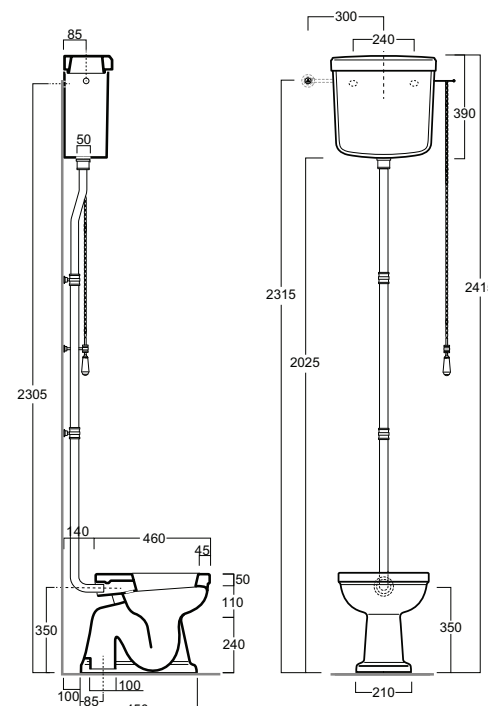
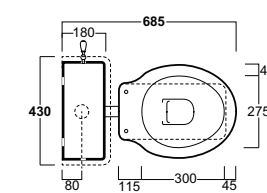
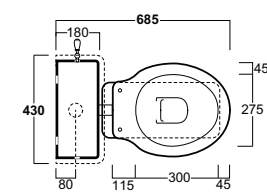
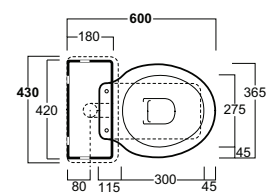
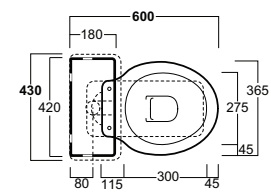
*Low-level cistern with lid for WC LO 911**Réservoir mi-hauteur avec couvercle pour cuvette LO 911**Niedrigstand-Spülkasten mit Deckel für WC LO 911**Устанавливаемый сзади бачок с крышкой для унитаза LO 911***F 89**

kg 0,18

Set viti di fissaggio per lavabo

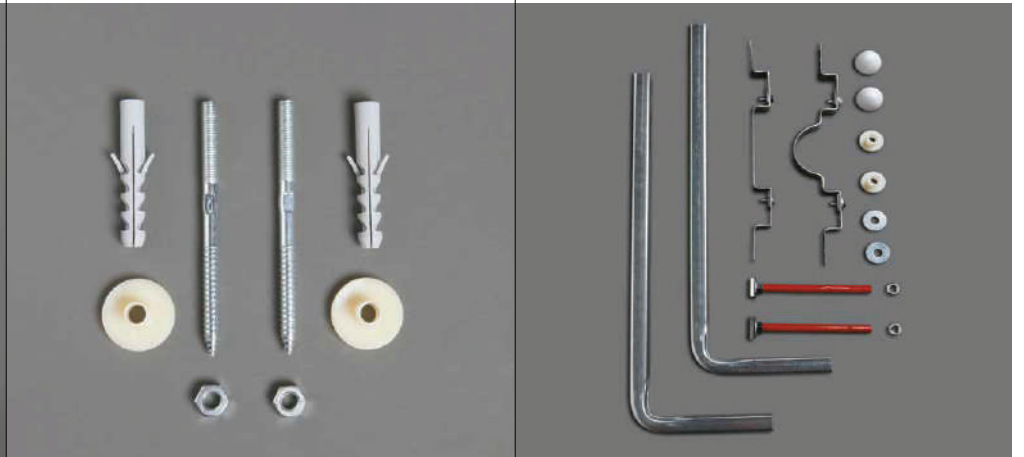
*Set fixing screws for washbasin**Set de vis de fixation pour lavabo**Montageset Waschbecken**Комплект крепежных винтов для раковины***F 84**

kg 3

Coppia staffe di fissaggio per vaso o bidet sospesi

*A pair of brackets for wall hung wc or bidet**Paire d'équerres de fixation pour cuvette ou bidet suspendus**Paar Befestigungshalterungen für Wandklosett oder Wandbidets**Пара крепёжных скоб для подвесных унитаза или биде***F 90**

kg 0,02

Set viti di fissaggio verticali cromo/bianco per vaso o bidet (oro/bronzo su richiesta)

*Set of chrome/white vertical fixing screws for wc or bidet (gold/bronze on demand)**Set de vis de fixation verticales chromé/blanc pour WC ou bidet (doré/bronze sur demande)**Montageset senkrecht weiss/chrom für WC oder Bidet (gold/bronze auf anfrage)**Комплект вертикальных крепежных винтов хром/белый для унитаза или биде (золото/бронза по заявке)*

**D 13**

kg 0,7

Batteria di scarico ad aria con pulsante cromo/oro/bronzo per cassetta monoblocco

*Push button flush mechanism in chrome/gold/bronze-finish for close coupled cistern*

*Batterie de vidage à air avec bouton chromé/doré/bronze pour réservoir mono bloc*

*Druckluft-Spülgarnitur mit Taste Chrom/Gold/Bronze für Komplett-Spülkasten*

*Пневматический механизм слива с хромированной кнопкой для моноблочного бачка. Хром/бронза/золото*

**D 21**

kg 1

Batteria di scarico doppio flusso cromo/oro/bronzo per cassetta monoblocco

*Push button double flush mechanism in chrome/gold/bronze-finish for close coupled cistern*

*Mécanisme de chasse, double chasse, avec bouton chromé/doré/bronze pour réservoir monobloc*

*Spuelung, 2-Mengen-Spuelung mit Taste Chrom/Gold/Bronze für Komplett-Spülkasten*

*Механизм слива с двойным потоком хромированный для моноблочного бачка. Хром/бронза/золото*

**D 11**

kg 1,5

Batteria di scarico per cassetta a zaino con tubo in ottone - cromo/oro/bronzo

*Flush mechanism for low-level cistern with plated brass pipe - chrome/gold/bronze-finish*

*Batterie de vidage pour réservoir mi-haut avec tuyau en laiton. Chromé/doré/bronze*

*Spülgarnitur für Halbhoch-Spülkasten mit Rohr in Messing Chrom/Gold/Bronze*

*Механизм слива для устанавливаемого сзади бачка с латунной трубой. Хром/бронза/золото*

**R 01**

kg 5

Batteria di scarico esterna per cassetta alta LA 06 (R 02 + R 03) cromo/oro/bronzo

*Flush mechanism for high-level cistern LA 06 (R 02 + R 03) chrome/gold/bronze finish*

*Batterie de vidage extérieure pour réservoir haut LA 06 (R 02 + R 03) en chrome/bronze/or*

*Aufputz-Spülgarnitur für hohen Spülkasten LA 06 (R 02 + R 03) in chrom/bronze/gold*

*Наружный механизм слива для высоко бачка LA06 (R 02 + R 03). Хром/бронза/золото*

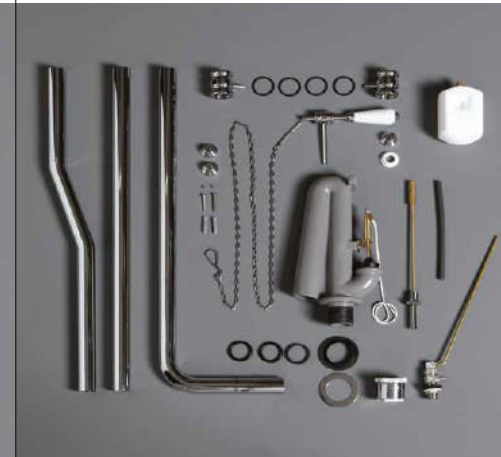
**R 02**

kg 3

Batteria di scarico ad aria con asta, pull in resina bianca, catenella cromo/oro/bronzo

*Flush mechanism with chain & pull in white resin chrome/gold/bronze finish*

*Batterie de vidage à air avec tige, tirette en résine blanche, chaînette en chrome/bronze/or*

*Druckluft-Spülgarnitur mit Stange, Zug in weißem Kunststoff, Kette in chrom/bronze/gold*

*Пневматический механизм слива со штоком, ручкой из синтетической смолы белого цвета, цепочкой. Хром/бронза/золото*

**R 03**

kg 1

Tubo di scarico per R 02 cromo/oro/bronzo

*Flush pipe for R 02 chrome/gold/bronze finish*

*Tuyau de vidage pour R 02 en chrome/bronze/or*

*Abflussrohr für R 02 in chrom/bronze/gold*

*Сливная труба для R 02. Хром/бронза/золото*

**LO 002**

kg 3

Coprivaso in poliestere con cerniere cromo  
*Polyester toilet seat with chrome-finish hinges*  
*Abattant en polyester avec des charnières chrome*  
*WC Deckel in Polyester mit Chromscharnieren*  
*Сиденье, полиэстер, шарниры - хром*

**LO 003**

kg 3

Coprivaso in poliestere con cerniere oro/bronzo  
*Polyester toilet seat with gold/bronze-finish hinges*  
*Abattant en polyester avec des charnières or/ bronze*  
*WC Deckel in Polyester mit Scharnieren in Gold/Bronze*  
*Сиденье, полиэстер, шарниры - золото/бронза*

**LO 006**

kg 3

Coprivaso in poliestere con cerniere rallentate cromo  
*Polyester toilet seat with chrome-finish soft-closing hinges*  
*Abattant en polyester avec charnières avec frein chrome*  
*WC-Sitz in Poliester mit Chromscharnieren mit Absenkautomatik*  
*Сиденье, полиэстер, петли хром, с микролифтом*

**LO 007**

kg 3

Coprivaso in poliestere con cerniere rallentate oro/bronzo  
*Polyester toilet seat with gold/bronze-finish soft-closing hinges*  
*Abattant en polyester avec charnières avec frein or/bronze*  
*WC-Sitz in Poliester mit verlangsamen Scharnieren in gold / bronze*  
*Сиденье, полиэстер, петли золото/бронза, с микролифтом*



**LO 004**

kg 3

Coprivaso in legno color noce con cerniere cromo  
 Wooden toilet seat walnut-finish with chrome-finish hinges  
 Abattant en bois couleur noyer avec des charnières chrome  
 WC- Sitz und Deckel in Holz, Farbe Nußbaum, mit Chromscharnieren  
 Сиденье, дерево – цвет- орех, шарниры – хром

**LO 005**

kg 3

Coprivaso in legno color noce con cerniere oro/bronzo  
 Wooden toilet seat walnut-finish with gold/bronze-finish hinges  
 Abattant en bois couleur noyer avec des charnières or/bronze  
 WC- Sitz und Deckel in Holz, Farbe Nußbaum, mit Scharnieren in Gold/Bronze  
 Сиденье, дерево – цвет- орех, шарниры – золото/бронза

**LO 919**

kg 17,5

Bidet monoforo sospeso  
 Wall hung bidet with single tap hole  
 Bidet mono trou suspendu  
 Hänge-Bidet, Einloch

Биде подвесное с одним отверстием

**LO 918**

kg 19

Vaso sospeso  
 Wall Hung WC  
 Cuvette suspendue  
 Hänge-WC

Унитаз подвесной

**LO 008**

kg 3

Coprivaso in legno color noce con cerniere rallentate cromo  
 Wooden toilet seat walnut-finish with chrome-finish soft-closing hinges  
 Abattant en bois avec charnières avec frein chrome  
 WC-Sitz I in Holz „Nuss“ mit verlangsamen Scharnieren in chrom  
 Сиденье, дерево, цвет - орех, петли хром, с микролифтом

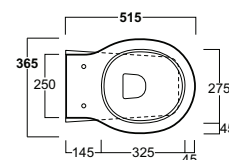
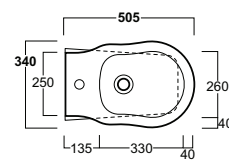
**LO 009**

kg 3

Coprivaso in legno color noce con cerniere rallentate oro/bronzo  
 Wooden toilet seat walnut-finish with gold/bronze-finish soft-closing hinges  
 Abattant en bois avec charnières avec frein or/bronze  
 WC-Sitz in Holz „Nuss“ mit verlangsamen Scharnieren in gold/bronze  
 Сиденье, дерево, цвет - орех, петли золото/бронза, с микролифтом

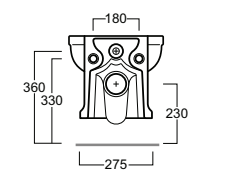
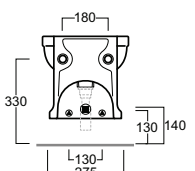
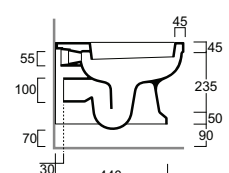
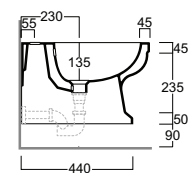
**LO 002S**

kg 3

Coprivaso in poliestere con cerniere cromo  
 Polyester toilet seat with chrome-finish hinges  
 Abattant en polyester avec des charnières chrome  
 WC Deckel in Polyester mit Chromscharnieren  
 Сиденье, полиэстер, шарниры - хром

**LO 003S**

kg 3

Coprivaso in poliestere con cerniere oro/bronzo  
 Polyester toilet seat with gold/bronze-finish hinges  
 Abattant en polyester avec des charnières or/ bronze  
 WC Deckel in Polyester mit Scharnieren in Gold/Bronze  
 Сиденье, полиэстер, шарниры – золото/бронза

Solo per LO 918  
 Only for LO 918  
 Uniquement pour le LO 918  
 Nur für das LO 918  
 только для LO 918

**LO 004S**

kg 3

Coprivaso in legno color noce con cerniere cromo  
 Wooden toilet seat walnut-finish with chrome-finish hinges  
 Abattant en bois couleur noyer avec des charnières chrome  
 WC- Sitz und Deckel in Holz, Farbe Nußbaum, mit Chromscharnieren  
 Сиденье, дерево – цвет- орех, шарниры – хром

**LO 005S**

kg 3

Coprivaso in legno color noce con cerniere oro/bronzo  
 Wooden toilet seat walnut-finish with gold/bronze-finish hinges  
 Abattant en bois couleur noyer avec des charnières or/bronze  
 WC- Sitz und Deckel in Holz, Farbe Nußbaum, mit Scharnieren in Gold/Bronze  
 Сиденье, дерево – цвет- орех, шарниры – золото/бронза

Solo per LO 918  
 Only for LO 918  
 Uniquement pour le LO 918  
 Nur für das LO 918  
 только для LO 918

**LO 006S**

kg 3

Coprivaso in poliestere con cerniere rallentate cromo  
 Polyester toilet seat with chrome-finish soft-closing hinges  
 Abattant en polyester avec charnières avec frein chrome  
 WC-Sitz in Polyester mit Chromscharnieren mit Absenkautomatik  
 Сиденье, полиэстер, петли хром, с микролифтом

**LO 007S**

kg 3

Coprivaso in poliestere con cerniere rallentate oro/bronzo  
 Polyester toilet seat with gold/bronze-finish soft-closing hinges  
 Abattant en polyester avec charnières avec frein or/bronze  
 WC-Sitz in Polyester mit verlangsamen Scharnieren in gold / bronze  
 Сиденье, полиэстер, петли золото/бронза, с микролифтом

**LO 008S**

kg 3

Coprivaso in legno color noce con cerniere rallentate cromo  
 Wooden toilet seat walnut-finish with chrome-finish soft-closing hinges  
 Abattant en bois avec charnières avec frein chrome  
 WC-Sitz I in Holz „Nuss“ mit verlangsamen Scharnieren in chrom  
 Сиденье, дерево, цвет - орех, петли хром, с микролифтом

**LO 009S**

kg 3

Coprivaso in legno color noce con cerniere rallentate oro/bronzo  
 Wooden toilet seat walnut-finish with gold/bronze-finish soft-closing hinges  
 Abattant en bois avec charnières avec frein or/bronze  
 WC-Sitz in Holz „Nuss“ mit verlangsamen Scharnieren in gold/bronze  
 Сиденье, дерево, цвет - орех, петли золото/бронза, с микролифтом

# evolution

DESIGN: TERRI PECORA

Le icone di specifici momenti storici di costume e di design sono i punti di partenza, reinterpretati e riprogettati in chiave neoclassico nella collezione EVOLUTION. Un salto a ritroso con uno styling contemporaneo, alla ricerca del giusto equilibrio fra ieri e oggi. L'idea di evoluzione è rappresentata dal "mutamento" graduale delle forme nel tempo. Un richiamo vintage per una nuova estetica in cui gioca il quadrato arrotondato, inconfondibile geometria dei giorni attuali.

Design icons which embody precise moments in art and history undergo a neoclassic reinterpretation, resulting in the EVOLUTION collection. A look at the past using contemporary lenses, seeking the perfect balance between yesterday and today. Forms gradually metamorphosing through time - this is evolution. Echoes of vintage in the rimmed borders and proportions but with rectangular forms and gently rounded corners - the new icon in contemporary design.

Les icônes de moments historiques spécifiques de coutume et de design sont les points de départ, réinterprétés et reconçus sous forme néoclassique dans la collection EVOLUTION. Un saut dans le passé mais un style contemporain, à la recherche du juste équilibre entre hier et aujourd'hui. L'idée d'évolution se retrouve dans la « mutation » graduelle des formes dans le temps. C'est un rappel vintage pour une nouvelle esthétique où s'amuse le carré arrondi, géométrie incomparable des jours actuels.

Die Ikonen historischer Momente für Brauchtum und Design sind die Ausgangspunkte, die auf neoklassizistisch Weise in der Kollektion EVOLUTION neu interpretiert und konzipiert werden. Ein Sprung in die Vergangenheit im zeitgenössischen Stil, auf der Suche nach dem perfekten Gleichgewicht zwischen gestern und heute. Das Konzept der Evolution steht für die allmähliche "Wandlung" der Formen mit der Zeit. Etwas Vintage für eine neue Optik, in der das abgerundete Quadrat, diese für unsere Zeit unverkennbare Form, eine Hauptrolle spielt.

Иконы особых исторических моментов традиций и дизайна являются исходными точками, по-новому рассматриваемыми и проектируемыми в неоклассический ключе в коллекции EVOLUTION. Обратный скачок в современном стиле в поиске соответствующего равновесия между вчерашним и сегодняшним днем. Идея эволюции представлена постепенным «изменением» форм с течением времени. Стремительный зов новой эстетики, в которой игра строится на закругленном квадрате, уникальной геометрии сегодняшних дней.



EVO 13 31x27x11

EVO 14 34x31x11

EVO 10 58x42x16



EVO 15 53x45x16

EVO 12 90x50x15

EVO 11 70x49x15



EVO 19 37x52x25

EVO 18 37x52x25

EVO 04 37x54x41,5

EVO 01 37x54x41,5

EVO 07 64x37x41,5  
EVO 09 25x13,5x44,5

# restyling neoclassica delle forme.

Neo-classic restyling of shapes.  
Réinterprétation néoclassique des formes.  
Neoklassizistisches Restyling der Formen.  
Неоклассический рестайлинг форм.

> **EVO 11**  
Consolle 70  
Console 70

> **EVO 03**  
Colonna  
Pedestal

**EVO 01** >  
Vaso carenato  
Back to wall WC

< **EVO 04**  
Single hole bidet  
Bidet monoforo

**EVO 11**

Lavabo 70 sospeso o su colonna  
 Washbasin 70 wall hung or on pedestal  
 Lavabo 70 suspendu ou sur colonne  
 Waschbecken 70 wandhängend oder auf Säule  
 Раковина 70 с одним отверстием подвесная либо на пьедестале



**ACCESSORI DI COMPLETAMENTO**  
**ACCESSORIES AVAILABLE**

**EVO 03** Colonna  
 Pedestal

**EVO 12**

Consolle 90 sospesa o su colonna  
 Console 90 wall hung or on pedestal  
 Console 90 suspendue ou sur colonne  
 Konsole 90 wandhängend oder auf Säule  
 Консоль 90 с одним отверстием подвесная  
 либо на пьедестале



**ACCESSORI DI COMPLETAMENTO**  
**ACCESSORIES AVAILABLE**

**EVO 03** Colonna  
 Pedestal

**EVO 10**

Lavabo 58 da appoggio  
 Counter top washbasin 58  
 Lavabo 58 d'appui  
 Aufsatzwaschbecken 58  
 Раковина 58 накладная.

**EVO 15**

Lavabo 53 sospeso  
 Wall hung washbasin 53  
 Lavabo 53 suspendu  
 Hängewaschbecken 53  
 Раковина 53 подвесная



**EVO 14**

Lavamani 34 sospeso  
 Wall hung wash-hand basin 34  
 Lave-mains 34 suspendu  
 Waschbecken hängend 34  
 Раукмойник подвесной 34

**EVO 18**

Vaso sospeso. Completo di set di fissaggio F 85  
 Wall hung WC. Complete with fixing set F 85  
 Cuvette suspendue. Complet de set de fixation F 85  
 Hänge-WC. Inklusive Befestigungsset F 85  
 Унитаз подвесной вместе с крепежным комплектом F 85

**EVO 19**

Bidet sospeso monoforo. Completo di set di fissaggio F 85  
 Wall hung bidet with single tap hole. Complete with fixing set F 85  
 Bidet suspendu mono trou. Complet de set de fixation F 85  
 Hänge-Bidet, Einloch. Inklusive Befestigungsset F 85  
 Биде подвесное с одним отверстием. Комплектуется набором крепежей F 85

**EVO 13**

Lavamani 31 sospeso  
 Wall hung wash-hand basin 31

**EVO 14**

Lavamani 34 sospeso  
 Wall hung wash-hand basin 34



**ACCESSORI DI COMPLETAMENTO**  
**ACCESSORIES AVAILABLE**

**EVO 003** Coprivaso avvolgente in termoindurente con cerniere cromo  
 Wrap-around thermoset toilet seat with chrome-finish hinges  
**EVO 004** Coprivaso avvolgente in termoindurente con cerniere rallentate cromo  
 Wrap-around thermoset toilet seat with chrome-finish soft-closing hinges

**EVO 04**

*Bidet monoforo carenato*  
*Back to wall bidet with single tap hole*  
*Bidet mono trou caréné*  
*Bidet, Einloch, verkleidet*  
*Биде приставное с одним отверстием*

**EVO 01**

*Vaso carenato con scarico parete o pavimento*  
*Back to wall WC with wall or floor outlet*  
*Cuvette carénée décharge au mur ou au sol*  
*WC, verkleidet, Wand- oder Bodenanschluss*  
*Унитаз приставной. Горизонтальный или вертикальный слив*

**EVO 07**

*Vaso monoblocco carenato con scarico a parete o pavimento*  
*Back to wall close coupled WC with wall or floor outlet*  
*Cuvette mono bloc carénée avec décharge au mur ou au sol*  
*Monoblock-WC, verkleidet, Wand- oder Bodenanschluss*  
*Унитаз моноблок. Горизонтальный или вертикальный слив*

**EVO 09**

*Cassetta con coperchio per vaso monoblocco*  
*Cistern with lid for close coupled WC*  
*Réservoir avec couvercle pour cuvette mono bloc*  
*Monoblock-Spülkasten*  
*Бачок с крышкой*



**ACCESSORI DI COMPLETAMENTO**  
**ACCESSORIES AVAILABLE**

**EVO 003** Coprivaso avvolgente in termoindurente con cerniere cromo  
*Wrap-around thermoset toilet seat with chrome-finish hinges*  
**EVO 004** Coprivaso avvolgente in termoindurente con cerniere rallentate cromo  
*Wrap-around thermoset toilet seat with chrome-finish soft-closing hinges*



**ACCESSORI DI COMPLETAMENTO**  
**ACCESSORIES AVAILABLE**

**EVO 003** Coprivaso avvolgente in termoindurente con cerniere cromo  
*Wrap-around thermoset toilet seat with chrome-finish hinges*  
**EVO 004** Coprivaso avvolgente in termoindurente con cerniere rallentate cromo  
*Wrap-around thermoset toilet seat with chrome-finish soft-closing hinges*  
**D 22** Batteria di scarico doppio flusso cromo per cassetta monoblocco  
*Push button double flush mechanism in chrome-finish for close coupled cistern*

**EVO 11 / EVO 03**

kg 20/10

Lavabo 70 monoforo predisposto per rubinetteria a tre fori. Installazione su colonna (EVO 03) o sospeso con F 86

Single hole washbasin 70 pre-punched for three tap holes. Wall hung with F 86 or to be mounted on pedestal (EVO 03)

Lavabo 70 mono trou prédisposé pour robinetterie a trois trous. Installation sur colonne (EVO 03) ou suspendu avec F 86

Einloch Waschtisch 70 für dreilocher Wasserhahne vorgesehen. Installation auf der Standsäulen (EVO 03) oder mit F 86 frei eingesetzt

Раковина 70 с одним открытым отверстием и с двумя намеченными отверстиями. Установка на пьедестал, либо подвесная с помощью крепежа F 86

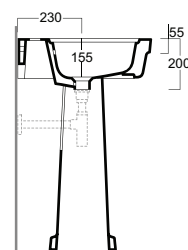
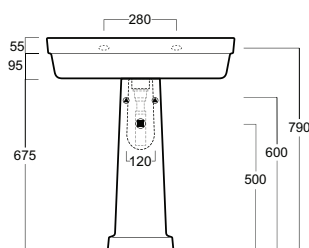
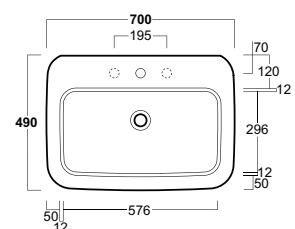
**EVO 12 / EVO 03**

kg 25/10

Console 90 monoforo predisposta per rubinetteria a tre fori. Installazione su colonna (EVO 03) o sospesa con F 86

Single hole console 90 pre-punched for three tap holes. Wall hung with F 86 or to be mounted on pedestal (EVO 03)

Console 90 mono trou prédisposée pour robinetterie a trois trous. Installation sur colonne (EVO 03) ou suspendu avec F 86

Einloch Konsole 90 für dreilocher Wasserhahne vorgesehen. Installation auf der Standsäulen (EVO 03) oder mit F 86 frei eingesetzt

Раковина 90 с одним открытым отверстием и с двумя намеченными отверстиями. Установка на пьедестал, либо подвесная с помощью крепежа F 86

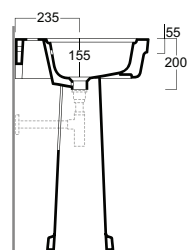
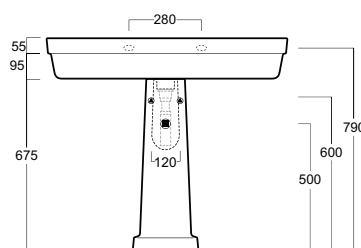
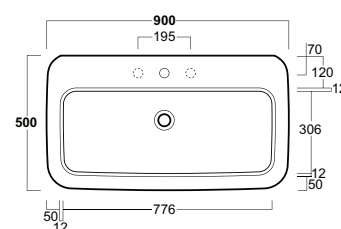
**EVO 15**

kg 14

Lavabo 53 monoforo predisposto per rubinetteria a tre fori. Installazione sospesa con F 86

Single hole washbasin 53 pre-punched for three tap holes. Wall hung installation with F 86

Lavabo 53 mono trou prédisposé pour robinetterie a trois trous. Installation suspendu avec F 86

Einloch Waschtisch 53 für dreilocher Wasserhahne. Installation mit F 86 frei eingesetzt

Раковина 53 с одним открытым отверстием и с двумя намеченными отверстиями. Подвесная с помощью крепежа F 86

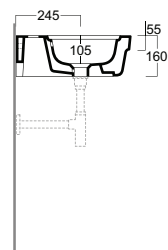
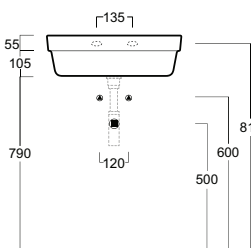
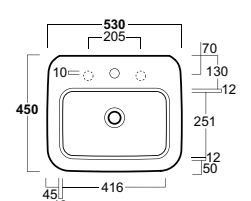
**EVO 14**

kg 7

Lavamani 34 monoforo sospeso

Single hole wall hung wash-hand basin 34

Lave mains 34 mono trou suspendu

Einloch Handwaschbecken 34 frei eingesetzt

Рукомойник 34 с одним отверстием, подвесной

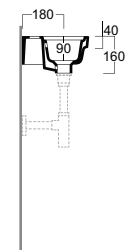
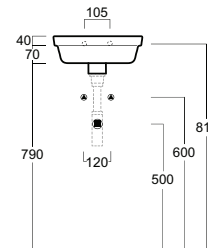
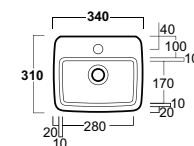
**EVO 13**

kg 6

Lavamani 31 monoforo sospeso

Single hole wall hung wash-hand basin 31

Lave mains 31 mono trou suspendu

Einloch Handwaschbecken 31 frei eingesetzt

Рукомойник 31 с одним отверстием, подвесной

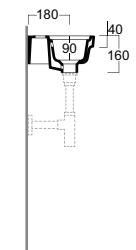
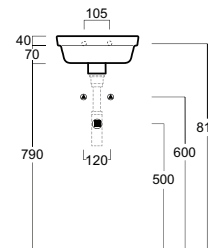
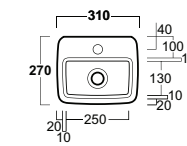
**EVO 10**

kg 13

Lavabo 58 da appoggio

Counter top washbasin 58

Lavabo 58 d'appui

Aufsatzwaschbecken 58

Раковина 58 накладная

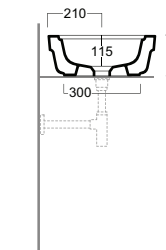
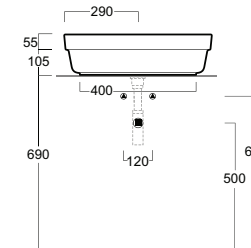
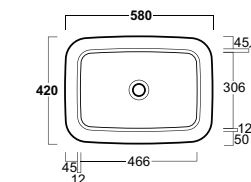

**EVO 04**

kg 20

Bidet monoforo carenato predisposto per rubinetteria a tre fori

*Single hole back to wall bidet pre-punched for three tap holes*

*Bidet mono trou caréné prédisposé pour robinetterie à trois trous*

*Vergekleid einloch bidet für dreilocher Wasserhahne*

*Биде с одним открытым отверстием и с двумя намеченными отверстиями*

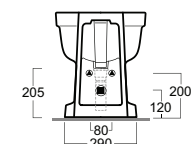
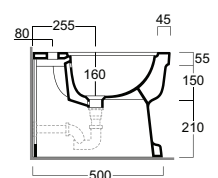
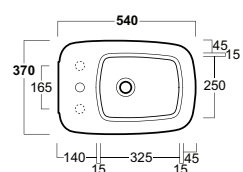
**EVO 01**

kg 24

Vaso carenato con scarico parete o pavimento (curva tecnica inclusa)

*Back to wall WC with wall or floor outlet (curved pipe included)*

*Cuvette carénée décharge au mur ou au sol (courbe technique incluse)*

*WC, verkleidet. Wand- oder Bodenanschluss (Inklusive Bogenrohr)*

*Унитаз приставной. Горизонтальный или вертикальный слив (техническое колено включено в комплектацию)*

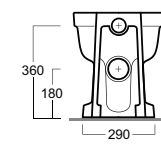
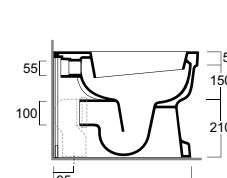
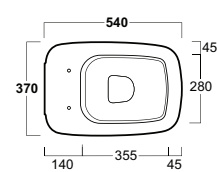
**EVO 19 / F 85**

kg 15

Bidet monoforo sospeso. Completo di set di fissaggio F 85

*Wall hung bidet with single tap hole. Complete with fixing set F 85*

*Bidet mono trou suspendu. Complet de set de fixation F 85*

*Hänge-Bidet, Einloch. Inklusive Befestigungsset F 85*

*Биде подвесное с одним отверстием. Комплектуется набором крепежей F 85*

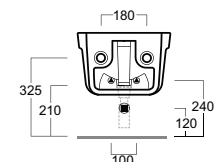
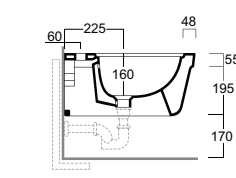
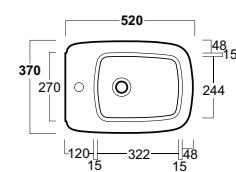
**EVO 18 / F 85**

kg 18

Vaso sospeso. Completo di set di fissaggio F 85

*Wall hung WC. Complete with fixing set F 85*

*Cuvette suspendue. Complet de set de fixation F 85*

*Hänge-WC. Inklusive Befestigungsset F 85*

*Унитаз подвесной. Комплектуется набором крепежей F 85*

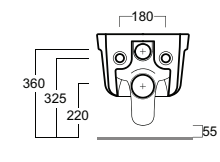
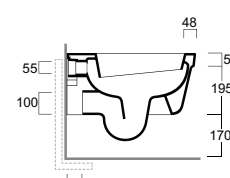
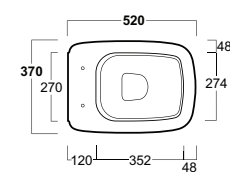
**EVO 07**

kg 29

Vaso monoblocco carenato con scarico parete o pavimento (curva tecnica inclusa)

*Back to wall close coupled WC with wall or floor outlet (curved pipe included)*

*Cuvette mono bloc carénée avec décharge au mur ou au sol (courbe technique incluse)*

*Monoblock-WC, verkleidet. Wand- oder Bodenanschluss (Inklusive Bogenrohr)*

*Унитаз моноблок. Горизонтальный или вертикальный слив (техническое колено включено в комплектацию)*

**EVO 09**

kg 12

Cassetta con coperchio per vaso monoblocco  
Cistern with lid for close coupled WC  
Réservoir avec couvercle pour cuvette monobloc  
Monoblock-Spülkasten  
Бачок с крышкой

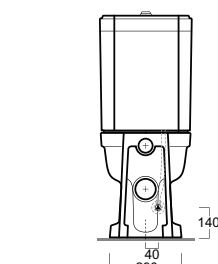
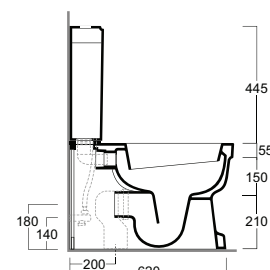
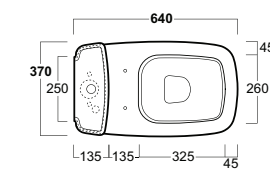
**EVO 003**

kg 2,6

Coprivaso avvolgente in termoindurente con cerniere cromo

*Wrap-around thermoset toilet seat with chrome-finish hinges*

*Abattant enveloppant en thermo durcisseur avec des charnières chrome*

*WC Deckel, thermoverformt, Chromscharniere*

*Сиденье из терморезины, шарниры хром*

**EVO 004**

kg 2,6

Coprivaso avvolgente in termoindurente con cerniere rallentate cromo

*Wrap-around thermoset toilet seat with chrome-finish soft-closing hinges*

*Abattant enveloppant en thermo durcisseur avec des charnières ralenties chrome*

*WC Deckel, thermoverformt, Chromscharniere mit Absenkautomatik*

*Сиденье из терморезины, хром, с микролифтом*

**D 22**

kg 1

Batteria di scarico doppio flusso cromo per cassetta monoblocco LFT 26/EVO 09/EL 09

*Push button double flush mechanism in chrome-finish for close coupled cistern LFT 26/EVO 09/EL 09*

*Mécanisme de chasse, double chasse, avec bouton chromé pour réservoir monobloc LFT 26/EVO 09/EL 09*

*Spuelung, 2-Mengen-Spuelung mit WC-Taste in Chrom für Komplett-Spülkasten LFT 26/EVO 09/EL 09*

*Механизм слива с двойным потоком хромированный для моноблочного бачка LFT 26/EVO 09/EL 09*

**F 84**

kg 3

Coppia staffe di fissaggio per vaso o bidet sospesi

*A pair of brackets for wall hung wc or bidet*

*Paire d'équerres de fixation pour cuvette ou bidet suspendus*

*Paar Befestigungshalterungen für Wandklosett oder Wandbidets*

*Пара крепёжных скоб для подвесных унитаза или биде*

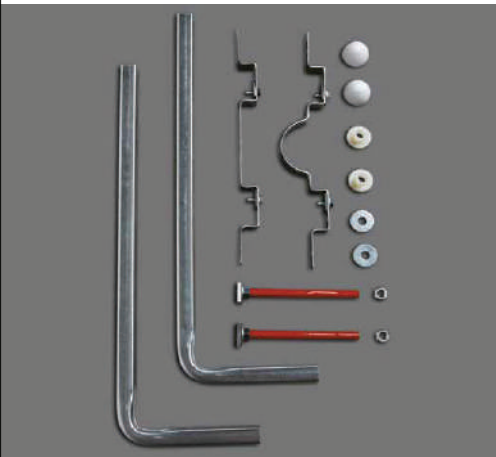
**F 86**

kg 2,2

Staffa di fissaggio per lavabi sospesi (EVO 11 / EVO 12 / EVO 15)

*Fitting system kit for wall-hung washbasins. (EVO 11 / EVO 12 / EVO 15)*

*Élément de fixation pour lavabos suspendus (EVO 11 / EVO 12 / EVO 15)*

*Befestigung Tragbügel für frei eingesetzt Waschtische (EVO 11 / EVO 12 / EVO 15)*

*Крепежная стойка для подвесных раковина (EVO 11, EVO 12, EVO 15)*

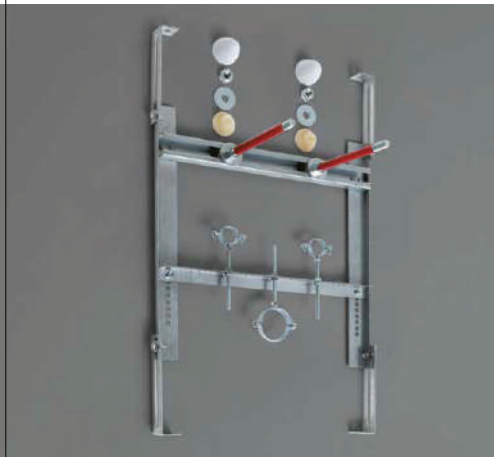
**F 85**

kg 0,3

Set viti fissaggio a completamento staffe F 84 per vaso o bidet sospeso

*Fixing Kit for F 84 brackets for wall hung WC or bidet*

*Jeu de vis de fixation pour équerre F 84 pour cuvette ou bidet suspendu*

*Satz Befestigungsschrauben zur Ergänzung der Halterungen F 84 Wandklosett oder Wandbidet*

*Комплект крепежных винтов для комплектования скоб F 84 для подвесного унитаза или биде*

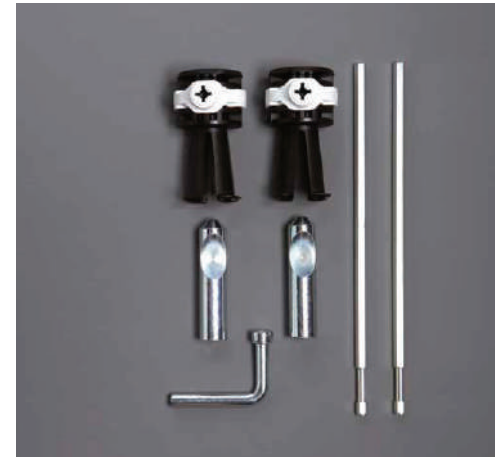
**F 89**

kg 0,18

Set viti di fissaggio per lavabo

*Set fixing screws for washbasin*

*Set de vis de fixation pour lavabo*

*Montageset Waschbecken*

*Комплект крепежных винтов для раковины*

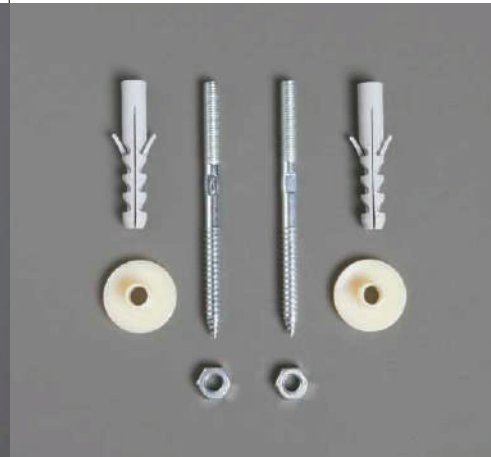
**SIF 165**

kg 1,1

Sifone cilindrico lavabo da 1 1/4"

*Cylindrical trap for washbasin 1 1/4"*

*Siphon cylindrique pour lavabo de 1 1/4"*

*Siphon, zylindrisch für Waschbecken 1 1/4"*

*Сифон цилиндрической формы для раковин*

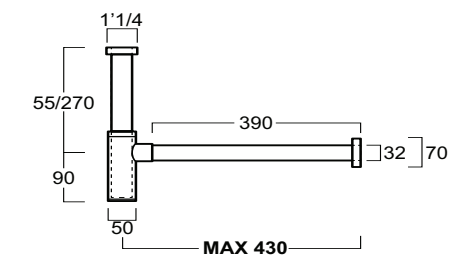

**SIF 270**

kg 1,4

Sifone cilindrico lavabo da 1<sup>1/4</sup>"*Cylindrical trap for washbasin 1<sup>1/4</sup>"**Siphon cylindrique pour lavabo de 1<sup>1/4</sup>"**Siphon, zylindrisch für Waschbecken 1<sup>1/4</sup>"**Сифон цилиндрической формы для раковин***SIF 125**

kg 1

Sifone cilindrico per bidet da 1<sup>1/4</sup>"*Cylindrical trap for bidet 1<sup>1/4</sup>"**Siphon cylindrique pour bidet de 1<sup>1/4</sup>"**Siphon, zylindrisch für Bidet 1<sup>1/4</sup>"**Цилиндрический сифон для биде 1<sup>1/4</sup>"***PLCR**

kg 0,4

Piletta "shut rapid" o "free flow" cromo

*Pop-up waste "shut rapid" or "free flow" chrome**Bonde "shut rapid" ou "free flow" chromée**Abflusstöpsel "Shut rapid" oder "free flow" chrom**Донный клапан типа "быстрый затвор" или "свободный поток" хром***PLCE**

kg 0,5

Piletta "shut rapid" o "free flow" in ceramica

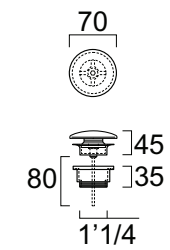
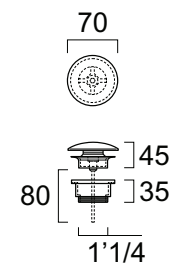
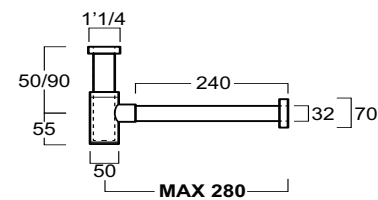
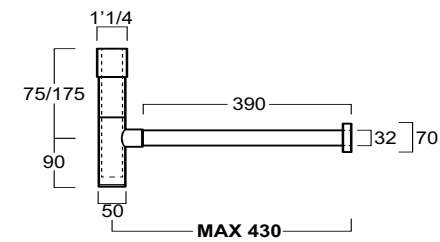
*Pop-up waste "shut rapid" or "free flow" ceramic**Bonde "shut rapid" ou "free flow" céramique**Abflusstöpsel "Shut rapid" oder "free flow" keramik**Донный клапан типа "быстрый затвор" или "свободный поток" керамика*

\* Disponibile in tutti i colori  
 Available in all colors  
 Disponible dans tous les coloris  
 Verfüegbar in alle die Farben  
 В наличии все цвета

# vasche

DESIGN: UFFICIO TECNICO + STUDIO LENCI + TERRI PECORA

Da sempre prodotte come corredo, le vasche continuano a essere un evergreen di successo, rigorosamente made in Italy. Rettangolari, ovali, in Crystal Tech, vetroresina o ghisa. Sempre in ghisa, con smalto interno ed esterno, la vasca con piedi d'appoggio decorati a rilievo che si ispira al Liberty. Per ambientazioni dal sapore classico.

Always in fashion, Simas bath tubs continue to "evergreen" success stories. Rectangular and oval forms, in Crystal Tech, resin or cast iron, all "made in Italy". For all interiors with a classic twist.

Depuis toujours produit comme trousseau, les baignoires continuent à être un evergreen de succès, rigoureusement made in Italy. Rectangulaires, ovales, en résine de verre, en Crystal Tech ou en fonte. Pour des milieux à la saveur classique.

Sie waren schon immer Teil der Produktpalette und sind seitdem ein Evergreen. Sei es rechteckig oder oval in Kunststoff, Crystal Tech oder Gusseisen., immer 100% made in Italy. Für ein Ambiente in klassischem Flair.

Издавна производившиеся как необходимое оснащение, ванны остаются актуальным предметом и по сей день, настоящим продуктом made in Italy. Прямоугольные, угловые, акриловые или чугунные. Чугунная ванна, эмалированная снаружи и внутри, с рельефными ножками в стиле Liberty. Для интерьеров в классике.



BO V1 190x88x66



30100 / 30101 153x77x76,5



VAT 17 / VAS 17 170x70x76

**BO V1**

Vasca in Crystal Tech completa di piletta sifonata  
*Crystal Tech bath tub pop-up waste drainer included*  
 Baignoire en Crystal Tech avec bocard à décharge  
 Badewanne in Crystal Tech mit abfluss  
 Ванна из Crystal Tech, укомплектованная стоком с сифоном





**BO V1**

Vasca in Crystal Tech completa di piletta sifonata  
*Crystal Tech bath tub pop-up waste drainer included*  
 Baignoire en Crystal Tech avec bocard à décharge  
*Badewanne in Crystal Tech mit abfluss*  
 Ванна из Crystal Tech, укомплектованная стоком с сифоном

**BO V1**

Vasca in Crystal Tech completa di piletta sifonata  
*Crystal Tech bath tub pop-up waste drainer included*  
 Baignoire en Crystal Tech avec bocard à décharge  
*Badewanne in Crystal Tech mit abfluss*  
 Ванна из Crystal Tech, укомплектованная стоком с сифоном



## Vasca in Crystal Tech®



### BO V1 kg 170

Vasca in Crystal Tech completa di piletta sifonata

*Crystal Tech bath tub pop-up waste drainer included*

*Baignoire en Crystal Tech avec bocard à décharge*

*Badewanne in Crystal Tech mit abfluss*

*Ванна из Crystal Tech, укомплектованная стоком с сифоном*

Crystal Tech® bath tub  
Baignoire en Crystal Tech®  
Badewanne in Crystal Tech®  
Ванна из Crystal Tech®

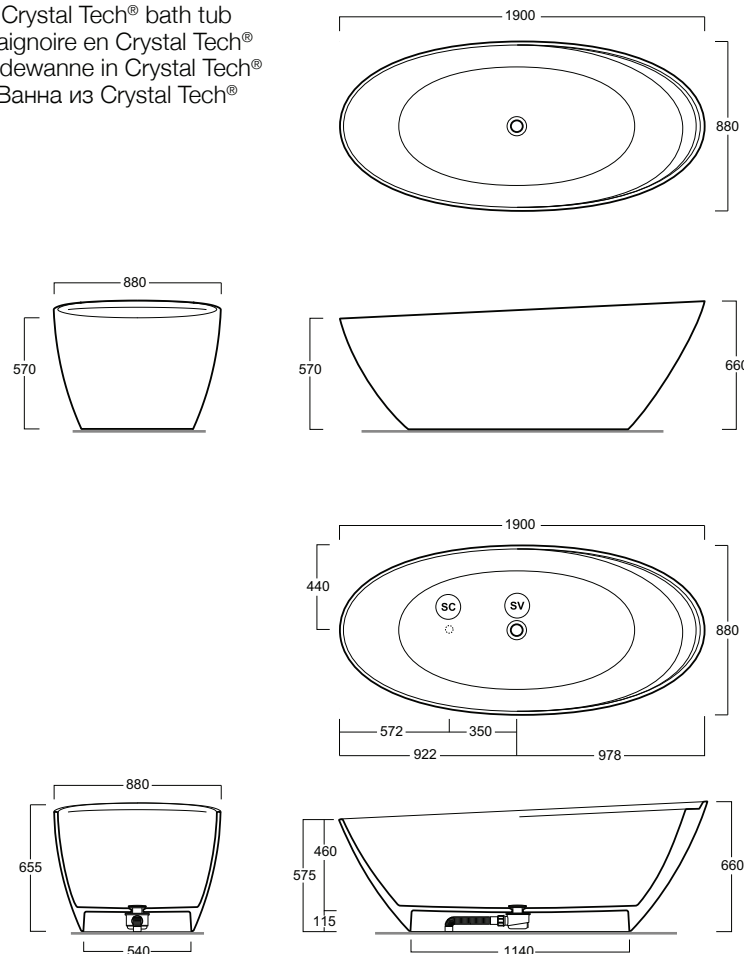

#### CrystalTech®

Materiale composto da due parti. Spesso strato esterno di resina ISO-NPG per conferire brillantezza, impermeabilità, resistenza e qualità estetiche. Interno in miscela di resina poliestere addizionata a cariche inerti per definire le caratteristiche meccaniche. CrystalTech® è resistente a solventi, acidi e alle normali sostanze liquide per la pulizia. Leggeri graffi possono essere rimossi con pasta lucidante. In caso di scheggiature o incisioni profonde, l'apposito kit di riparazione ripristina la superficie originale.

#### CrystalTech®

Material composed of two parts. A thick outer layer of ISO-NPG resin to give shine, impermeability, resistance and aesthetic quality, and an interior of polyester resin mixture with inert fillers to define the mechanical characteristics. CrystalTech® is resistant to solvents, acids and normal liquid cleaning substances. Light scratches can be removed with the polishing paste. In case of chipping or deep scratches, the special repair kit can restore the surface to its original condition.

#### CrystalTech®

*Matériau composé de deux parties. Une couche épaisse externe de résine ISO-NPG qui apporte brillance, imperméabilité, résistance et qualités esthétiques. Une couche interne en mélange de résine polyester additionnée de charges inertes pour définir les caractéristiques mécaniques. CrystalTech® résiste aux solvants, aux acides et aux substances liquides classiques pour le nettoyage. Les rayures légères peuvent être éliminées à l'aide d'une pâte à polir. En cas d'ébréchantures ou de rayures profondes, le kit de réparation prévu à cet effet permet de rétablir la surface originale.*

#### CrystalTech®

Material bestehend aus zwei Teilen. Eine dicker äußere Schicht aus ISO-NPG Kunstharz, um Brillanz, Wasserundurchlässigkeit, Resistenz und ästhetische Qualität zu verleihen. Innen eine Mischung aus Polyesterharzen mit Zusatzstoffen, um die mechanischen Eigenschaften zu gewährleisten. CrystalTech® ist gegenüber Lösungsmitteln, Säuren, und den normalen Reinigungsmitteln resistent. Leichte Kratzer

*können mit der Polierpaste beseitigt werden. Bei Absplittern oder tiefen Kratzern stellt das entsprechende Reparaturkit die Originaloberfläche wieder her.*

#### CrystalTech®

Материал состоит из двух частей. Толстый внешний слой смолы ISO-NPG для придания блеска, непроницаемости, прочности и эстетических характеристик. Внутренняя поверхность из полиэфирной смолы с добавлением инертного потенциала для определения механических характеристик. CrystalTech® является устойчивым к растворителям, кислотам и нормальным жидким чистящим средствам. Небольшие царапины могут удаляться посредством полировальной пасты. В случае глубоких трещин или царапин специальный ремонтный комплект восстанавливает первоначальный внешний вид поверхности.

### Imballaggio speciale per BO V1

#### Kg.220 totali BO V1 + imballaggio

SPECIAL PACKAGING FOR BO V1  
EMBALLAGE SPÉCIAL POUR BO V1  
SPEZIALVERPACKUNG FÜR BO V1  
СПЕЦИАЛЬНАЯ УПАКОВКА ДЛЯ BO V1

La vasca Bohémien è dotata di un imballaggio speciale che garantisce il mantenimento della qualità nel trasporto grazie a un involucro protettivo in polistirolo e permette un'estrema praticità di installazione. Grazie a un sistema a rotelle è possibile trasportare senza fatica il pezzo nel luogo desiderato. Una volta posizionato l'imballo in prossimità del posto in cui viene installata la vasca, bastano alcuni semplici passaggi per consentire di estrarla e posizionarla in maniera comoda e precisa. Per maggiori informazioni consultare il manuale di montaggio presente nella confezione.

*The packaging of the Bohémien bathtub comes with a special protective polystyrene wrapping that guarantees its quality during transportation and makes installation extremely practical. Special wheels allow effortlessly transporting the item to the desired location. Once the package has been positioned near the spot where the tub will be installed, only a few simple steps are needed to remove and position it safely and accurately. For more information, refer to the assembly instructions contained in the packaging.*

*La baignoire Bohémien est équipée d'un emballage spécial qui garantit le maintien de la qualité lors du transport grâce à une enveloppe de protection en polystyrène et qui permet de l'installer très facilement dans votre maison. Grâce au système de roulettes, vous pourrez la transporter sans effort dans le lieu désiré. Après avoir placé l'emballage près du lieu où la baignoire sera installée, il suffira de quelques étapes simples pour vous permettre de l'extraire et de la positionner de façon pratique et précise. Consultez la notice de montage présente dans l'emballage pour de plus amples informations.*

Das Becken Bohémien bekommt eine spezielle Verpackung, um sicher zu stellen, dass die Qualität während des Transport gleichbleibend hoch ist. Dafür wird ein spezieller Schutzmantel aus Polystyrol verwendet, der ein schnelles Aufbauen in Ihrem Haus gestattet. Dank eines speziellen Rollensystems kann das Becken ohne Schwierigkeiten an den gewünschten Ort transportiert werden. Nachdem die Verpackung in der Nähe des Ortes, an dem das Becken installiert werden soll, gebracht wurde, reichen nur wenige Handgriffe, um es aus der Schutzhülle zu befreien und einfach und präzise aufzustellen. Für weitere Informationen sehen Sie ins Handbuch, das Ihnen bei der Lieferung mitgegeben wurde.

Ванна Bohémien оснащена специальной упаковкой, гарантирующей сохранение характеристик продукта в ходе транспортировки благодаря защитной оболочке из полистирола и обеспечивающей максимальную практичность установки в вашем доме. Благодаря системе на колесиках, можно легко перемещать продукцию в желаемое положение; После позиционирования упаковки рядом с местом монтажа ванны, необходимо выполнить некоторые простые действия для возможности ее извлечения и позиционирования удобным и точным образом. Для получения дополнительных сведений смотрите руководство по монтажу, вложенное в упаковку.

#### Passaggi

Steps  
Étapes  
Schritte  
Порядок действий

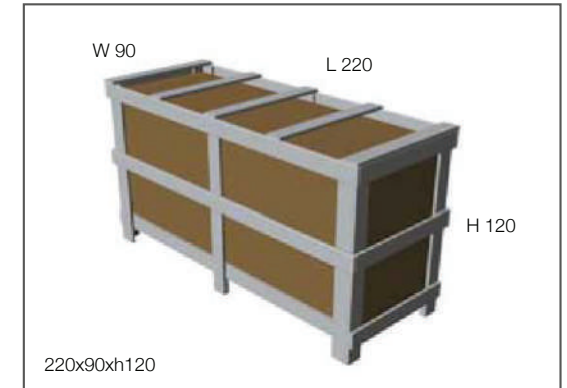

**30100**

Vasca in ghisa smalto interno ed esterno  
*Cast iron bath tub glazed internally and externally*  
*Baignoire en fonte vernis intérieur et extérieur*  
*Badewanne in Gusseisen, Maße, innen und außen beschichtet*  
 Чугунная ванна покрытая эмалью  
 внутри и снаружи

**ACCESSORI DI COMPLETAMENTO**  
**ACCESSORIES AVAILABLE**

**120017** Colonna di scarico esterna  
*Exposed bath tub waste-pipe*  
**120018** Sifone ribassato esterno  
*Low siphon*

**30101**

Vasca in ghisa smalto interno (lato esterno da trattare)  
*Cast iron bath tub glazed internally only (outer surface to be treated)*  
*Baignoire en fonte vernis intérieur (partie extérieur à traiter)*  
*Badewanne in Gusseisen, Maße, innenbeschichtet (zu behandelnde Aussenseite)*  
 Чугунная ванна см 153x76 покрытая эмалью внутри



**ACCESSORI DI COMPLETAMENTO**  
**ACCESSORIES AVAILABLE**

**120017** Colonna di scarico esterna  
*Exposed bath tub waste-pipe*  
**120018** Sifone ribassato esterno  
*Low siphon*

**VAT 17**

Vasca 170x70 rettangolare con telaio  
 Rectangular bath tub 170x70 with frame  
 Baignoire 170x70 rectangulaire avec châssis  
 Badewanne, rechteckig, Maße 170x70 cm, mit Gestell  
 Ванна прямоугольная с рамой 170x70

**ACCESSORI DI COMPLETAMENTO**  
**ACCESSORIES AVAILABLE**

**PLRB 17** Pannello laterale reversibile bianco  
*Reversible white side panel*

**PLRN 17** Pannello laterale reversibile noce  
*Reversible walnut side panel*

**PFB 17** Pannello frontale bianco  
*White anterior panel*

**PFN 17** Pannello frontale noce  
*Walnut anterior panel*

**CSV** Colonna di scarico vasca  
*Bath tub waste*



**VAT 17**

kg 31

Vasca 170x70 rettangolare con telaio  
(pannelli esclusi)

Rectangular bath tub 170x70 with frame  
(panels not included)

Baignoire rectangulaire cm. 170x70 massage  
avec châssis (exclus Panneaux)

Badewanne, rechteckig, Maße 170x70 cm,  
mit Gestell (ohne Frontpaneel)

Ванна 170x70 прямоугольная с рамой  
(без панелей)

**VAS 17**

kg 26

Vasca 170x70 rettangolare solo guscio

Rectangular bath tub 170x70

Baignoire rectangulaire cm 170x70

Badewanne, rechteckig, Maße 170x70 cm

Ванна 170x70 прямоугольная только с  
оболочкой

**PFB 17**

kg 5

Pannello frontale bianco

White anterior panel

Panneau frontal blanc

Frontpaneel, weiß

Фронтальная панель белая

**PFN 17**

kg 5

Pannello frontale noce

Walnut anterior panel

Panneau frontal noyer

Frontpaneel, nußfarben

Фронтальная панель орех

**PLRB 17**

kg 2

Pannello laterale reversibile bianco

Reversible white side panel

Panneau latérale réversible blanc

Seitenpaneel reversibel, weiß

Боковая реверсивная панель белая

**PLRN 17**

kg 2

Pannello laterale reversibile noce

Reversible walnut side panel

Panneau latérale réversible noyer

Seitenpaneel reversibel, nußfarben

Боковая реверсивная панель орех

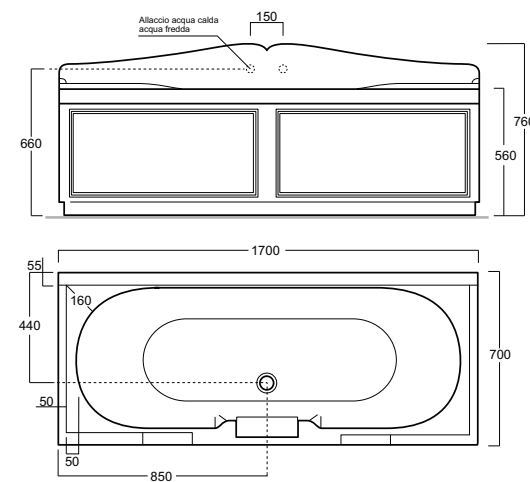

**CSV**

kg 0,7

Colonna di scarico vasca per VAS e VAT

*Bath tub waste for VAS and VAT**Colonne de vidage baignoire pour VAS et VAT**Säule Wannenabfluss für VAS und VAT**Сливной стояк слива ванны для VAS и VAT***30100**

kg 140

Vasca in ghisa smalto interno ed esterno

*Cast iron bath tub glazed internally and externally**Baignoire en fonte vernis intérieur et extérieur**Badewanne in Gusseisen, Maße, innen und außen beschichtet**Чугунная ванна покрытая эмалью внутри и снаружи***30101**

kg 140

Vasca in ghisa smalto interno (lato esterno da trattare)

*Cast iron bath tub glazed internally only (outer surface to be treated)**Baignoire en fonte vernis intérieur (partie extérieur à traiter)**Badewanne in Gusseisen, Maße, innenbeschichtet (zu behandelnde Aussenseite)**Чугунная ванна покрытая эмалью внутри***120017**

kg 2

Colonna di scarico esterna per vasca 30100 / 30101 cromo/oro/bronzo

*Exposed bath tub waste-pipe for bath 30100 / 30101 chrome/gold/bronze-finish**Colonne décharge extérieur pour Baignoire 30100 / 30101 en chrome/bronze/or**Säule Wannenabfluss, außen für Badewanne 30100 / 30101 in chrom/bronze/gold**Наружный сливной стояк для ванны 30100 / 30101. Хром/бронза/золото***120018**

kg 2

Sifone ribassato esterno per vasca 30100 / 30101 cromo/oro/bronzo

*Low siphon for bath 30100 / 30101 chrome/gold/bronze-finish**Siphon abaissé extérieur pour Baignoire 30100 / 30101 en chrome/bronze/or**Außensiphon, gesenkt für Badewanne 30100 / 30101 in chrom/bronze/gold**Наружный низкий сифон для ванны 30100 / 30101. Хром/бронза/золото***BO V1**

kg 170

Vasca in Crystal Tech completa di piletta sifonata

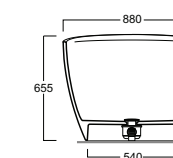
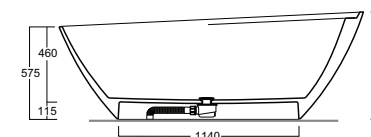
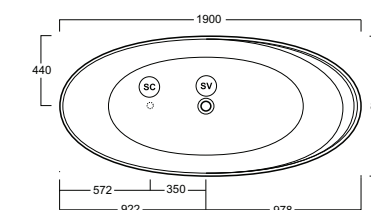
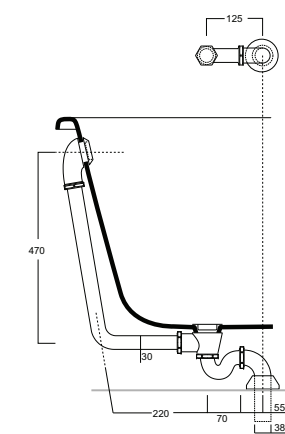
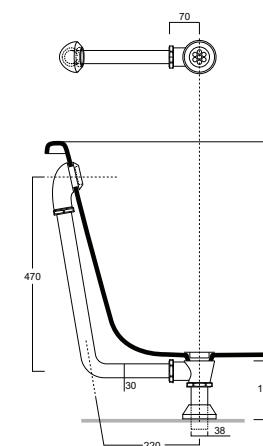
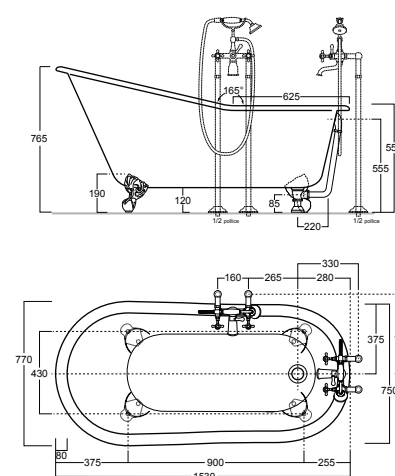
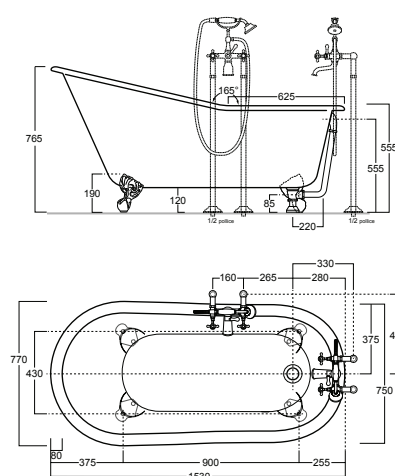
*Crystal Tech bath tub pop-up waste drainer included**Baignoire en Crystal Tech avec bocard à décharge**Badewanne in Crystal Tech mit abfluss**Ванна из Crystal Tech, укомплектованная стоком с сифоном*

# accessori

DESIGN: UFFICIO TECNICO

Victoria. Porta sapone, porta carta, porta asciugamani, porta scopino, applique, dove vince il cromo. Per corrispondere ampiamente alle aspettative di chi predilige lo stile classico.

Victoria. Soap dishes, toilet paper holders, appliqué elements-wherever Chrome is king. Made to fully satisfy the expectations of whomever lives with classic style.

Victoria. Porte savon, porte papier, porte serviette, porte brosse, des appliques, ou gagne le chrome. Pour répondre amplement aux expectatives de ceux qui préfèrent le style classique.

Victoria. Seifenhalter, Papierhalter, Handtuchhalter, Bürstenhalter. Applique Lampenschirm - wo auch immer Chrom eingesetzt werden soll. Um die Erwartungen aller zu erfüllen, die den klassischen Stil bevorzugen.

Victoria. Мыльницы, держатели туалетной бумаги, вешалки для полотенец, ершик, напольный и настенный радиаторы, бра... Чтобы соответствовать ожиданиям предпочитающих классический стиль.



260207



260210



260201



260203

45 MOB19  
45 MOB20  
45 MOB21

260208



260202



260205

260215  
260206

260204

**260207**

Portasapone con bicchiere da appoggio  
 Multipurpose dish  
 Porte savon avec verre d'appui  
 Seifenhalter mit Becherhalter  
 Мыльница с подстаканником накладная.

**260210**

Portasapone doppio con griglia  
 Multipurpose dish  
 Porte savon double avec grille  
 Seifenhalter, doppelt mit Gitterschale  
 Двойная мыльница с решеткой

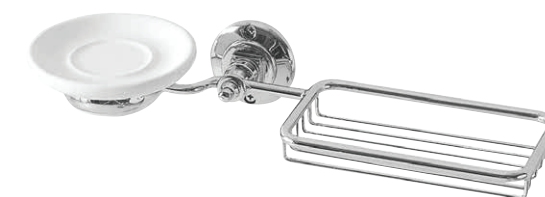
**260201**

Portasapone  
 Soap dish  
 Porte savon  
 Seifenhalter  
 Мыльница

**260203**

Portabicchiere  
 Glass holder  
 Porte verre  
 Becherhalter  
 Подстаканник





**45 MOB19 / 45 MOB21**

Applique con paralume  
 Applique with lamp shade  
 Applique avec abat jour  
 Wandleuchte mit Lampenschirm  
 Бра с абажуром

**260208**

Porta scopino  
 Toilet brush  
 Porte balayette  
 Bürstenhalter  
 Ершик



**260202**

Porta carta  
Toilet paper holder  
Porte papier  
Papierrolenhalter  
Держатель туалетной бумаги

**260205**

Porta asciugamani con anello  
Towel ring  
Porte serviette avec anneau  
Handtuchhalter mit Ring  
Вешалка-кольцо для полотенец

**260206**

Portasciugamani 60  
Towel rail 60  
Porte serviette 60  
Handtuchhalter 60  
Вешалка для полотенец 60

**260215**

Portasciugamani 40  
Towel rail 40  
Porte serviette 40  
Handtuchhalter 40  
Вешалка для полотенец 40

**260204**

Porta abito  
Robe-hook  
Porte manteau  
Kleiderhaken  
Крючок



**260201**

kg 0,7

Portasapone cromo/bronzo/oro

*Soap dish chrome/bronze/gold-finish**Porte savon en chrome/bronze/or**Seifenhalter in chrom/bronze/gold**Мыльница. Хром/бронза/золото***260203**

kg 0,7

Porta bicchiere cromo/bronzo/oro

*Glass holder chrome/bronze/gold-finish**Porte verre en chrome/bronze/or**Becherhalter in chrom/bronze/gold**Подстаканник. Хром/бронза/золото***260210**

kg 1

Portasapone doppio con griglia cromo/bronzo/oro

*Multipurpose dish chrome/bronze/gold-finish**Porte savon double avec grille en chrome/bronze/or**Seifenhalter, doppelt mit Gitterschale in chrom/bronze/gold**Двойная мыльница с решеткой. Хром/бронза/золото***260207**

kg 1

Portasapone con bicchiere da appoggio cromo/bronzo/oro

*Multipurpose dish chrome/bronze/gold-finish**Porte savon avec verre d'appui en chrome/bronze/or**Seifenhalter mit Becherhalter in chrom/bronze/gold**Мыльница с подстаканником накладная. Хром/бронза/золото***260204**

kg 0,6

Porta abito cromo/bronzo/oro

*Robe hook chrome/bronze/gold-finish**Porte manteau en chrome/bronze/or**Kleiderhaken n in chrom/bronze/gold**Крючок. Хром/бронза/золото***260205**

kg 0,7

Porta asciugamani con anello cromo/bronzo/oro

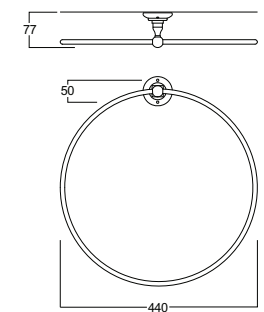
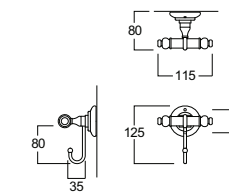
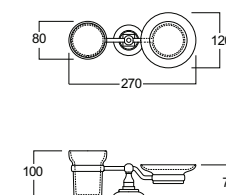
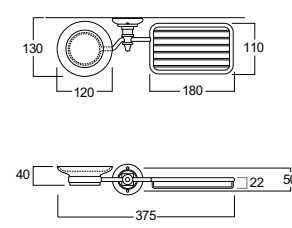
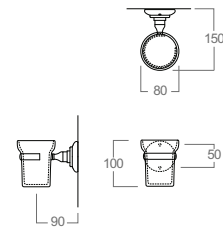
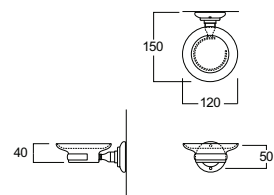
*Towel ring chrome/bronze/gold-finish**Porte serviette avec anneau en chrome, bronze et or**Handtuchhalter mit Ring in chrom, bronze, gold**Вешалка-кольцо для полотенец. Хром, бронза, золото*

**260215 / 260206**

kg 1,3

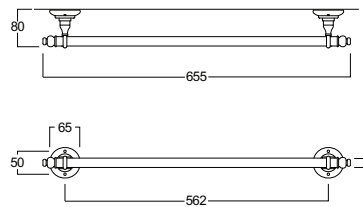
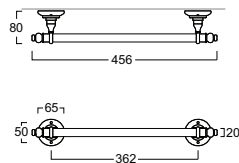
Portasciugamani da 40 cm e 60 cm in cromo/  
bronzo/oro*Towel rail 40 and 60 chrome/bronze/gold-finish**Porte serviette de 40 cm et 60 cm en chrome/  
bronze/or**Handtuchhalter 40 cm und 60 cm in chrom/  
bronze/gold**Вешалка для полотенец 40 см и 60 см. Хром/  
бронза/золото***260202**

kg 0,7

Porta carta cromo/bronzo/oro

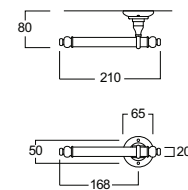
*Toilet paper holder chrome/bronze/gold-finish**Porte papier en chrome/bronze/or**Papierrolenhalter in chrom/bronze/gold**Держатель туалетной бумаги. Хром/бронза/  
золото***260208**

kg 1,5

Porta scopino cromo/bronzo/oro

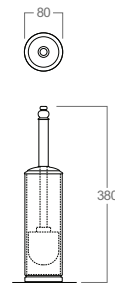
*Toilet brush chrome/bronze/gold-finish**Porte balayette en chrome/bronze/or**Bürstenhalter in chrom/bronze/gold**Ершик. Хром/бронза/золото***45 MOB19 / 45 MOB20 /  
45 MOB21**

kg 0,5

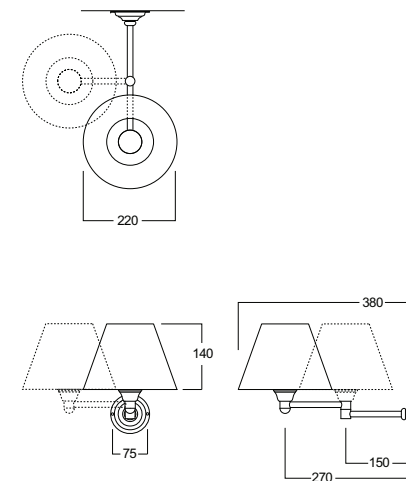
Applique in cromo (45 MOB19), bronzo e oro  
(45 MOB20) con paralume (45 MOB21)*Chrome (45 MOB19), bronze or gold (45 MOB20)  
applique with lamp shade (45 MOB21)**Applique en chrome (45 MOB19), bronze ou or  
(45 MOB20) avec abat jour (45 MOB21)**Wandleuchte in chrom (45 MOB19), bronze, gold  
(45 MOB20) mit lampenschirm (45 MOB21)**Бра с абажуром (45 MOB21). Хром (45 MOB19),  
бронза, золото (45 MOB20)*

# lavabi d'arredo

DESIGN: UFFICIO TECNICO - SIMONE MICHELI

Soluzioni intelligenti per il più antico degli elementi. Il lavabo assume forme e misure in sintonia con tutti gli spazi dell'abitare, pubblici o privati che siano. Strutture portanti o bacini sospesi, funzionali, flessibili, particolare. Denominatore comune, la qualità della manifattura made in Italy e lo stile del design.

Intelligent solutions for an object which Man has used since ancient times. The wash basin echoes the forms and dimensions of the other elements of its environment, whether public spaces or private homes. Built into their own piece of furniture or wall-mounted, functional, flexible, unique. The common denominator, high-quality Italian manufacture and design.

Solutions intelligentes pour le plus ancien des éléments. Le lavabo prend formes et dimensions en phase avec tous les espaces de l'habitat publics et privés soient ils. Structures en Olot ou vasques suspendues fonctionnelles souples uniques. Le point en commun la qualité de la manufacture made in Italy et le style du design.

Intelligente Lösungen für das älteste der Elemente. Das Waschbecken nimmt Formen und Größen an, die mit allen anderen Wohnräumen, sowohl öffentlichen als auch privaten, im harmonischen Einklang sind. Tragende Strukturen oder Wandelemente, funktionell, flexibel, einzigartig. Die gemeinsamen Nenner sind die Qualität der Made in Italy-Erzeugnisse und der Designstil.

Умные решения для одного из самых старинных элементов. Раковина гармонично вбирает в себя формы и размеры всех жилых пространств, вне зависимости от того, частные они или общественные. Несущие структуры или подвесные раковины, функциональные, мягкие, запоминающиеся формы. Качество производства made in Italy и стильный дизайн.

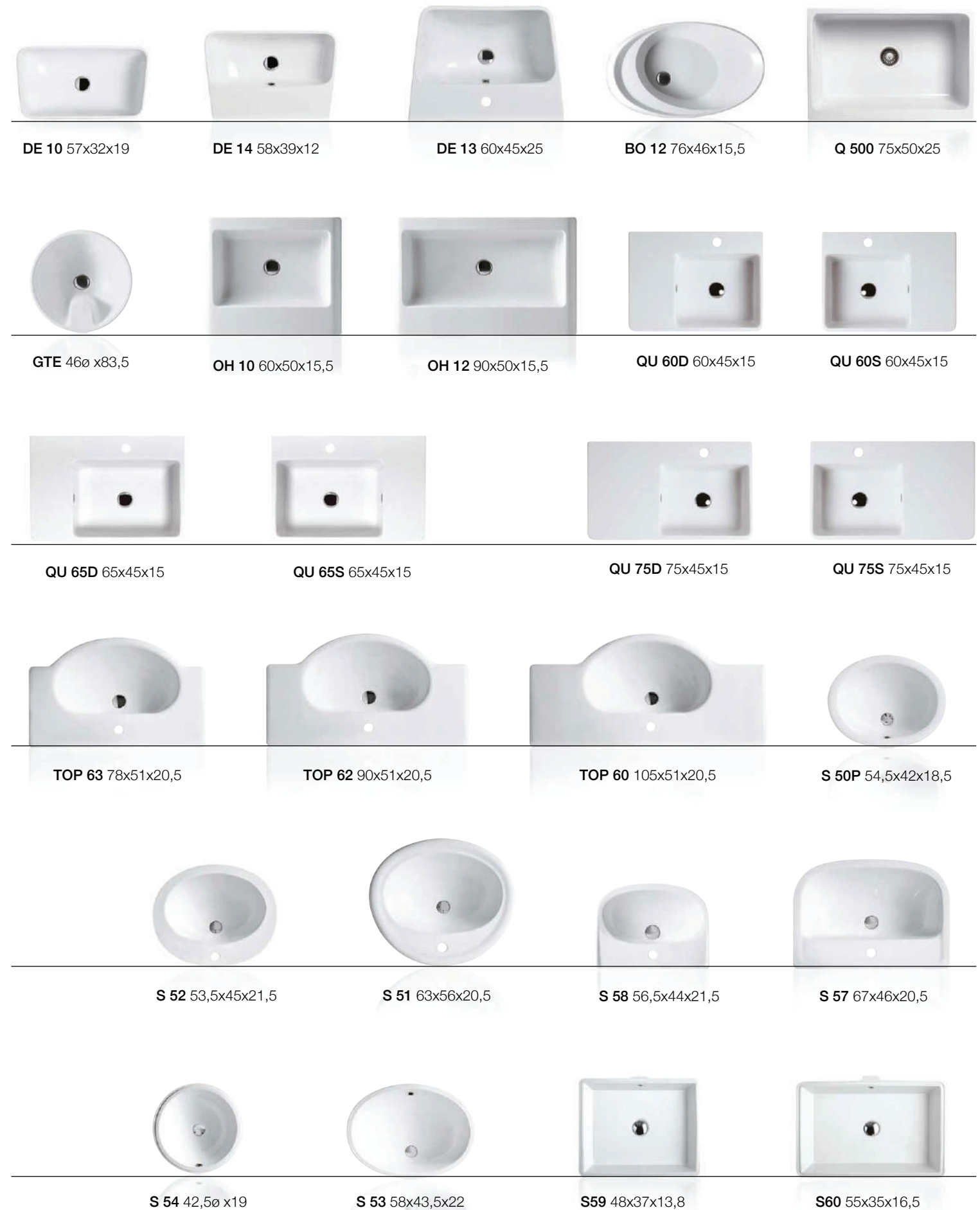

**DE 14**

Lavabo 58 sospeso monoforo  
 Wall hung washbasin 58 with single tap hole  
 Lavabo 58 suspendue mono trou  
 Hängendes 58-er Einloch – Waschbecken  
 Раковина 58 подвесная с одним отверстием

**DE 13**

Lavabo 60 sospeso monoforo  
 Wall hung washbasin 60 with single tap hole  
 Lavabo 60 suspendue mono trou  
 Hängendes 60-er Einloch – Waschbecken  
 Раковина 60 подвесная с одним отверстием



**DE 10**

Lavabo 57 da appoggio  
 Counter top washbasin 57  
 Lavabo 57 d'appui  
 Aufsatzwaschbecken 57  
 Раковина 57 накладная

**BO 12**

Lavabo 76 da appoggio predisposto monoforo  
 Counter top washbasin 76 pre-punched for single tap hole  
 Lavabo 76 d'appui prédisposé mono trou  
 Aufsatzwaschbecken 76, für Einlocharmatur  
 Раковина 76 накладная с одним намеченным отверстием



**GTE**

Lavabo cilindrico  
 Cylindrical washbasin  
 Lavabo cylindrique  
 Zylindrischer Waschtisch  
 Умывальник цилиндрической формы

**OH 10**

Lavabo 60 da appoggio o sospeso  
 Counter top or wall hung washbasin 60  
 Lavabo 60 d'appui ou suspendu  
 Waschbecken 60, Aufsatz oder wandhängend  
 Раковина 60 накладная или подвесная

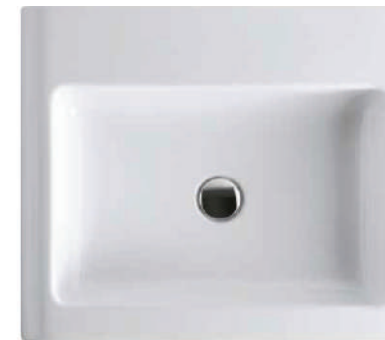
**OH 10**

Lavabo 60 da appoggio o sospeso  
 Counter top or wall hung washbasin 60

**OH 12**

Lavabo 90 da appoggio o sospeso  
 Counter top or wall hung washbasin 90



**QU 60S**

Lavabo Quasar 60 monoforo vasca sinistra. Installazione sospesa  
 Quasar 60cm basin with left side bowl 1 tap hole. Wall mounted  
 Lavabo 60 mono-trou vasque a' gauche. Installation suspendu  
 Waschbecken 60 cm mit Hahnloch und Ablagefläche Links  
 Раковина 60 с одним отверстием левая

**QU 60D**

Lavabo Quasar 60 monoforo vasca destra  
 Quasar 60cm basin with right side bowl 1 tap hole

**QU 60S**

Lavabo Quasar 60 monoforo vasca sinistra  
 Quasar 60cm basin with left side bowl 1 tap hole

**QU 65S**

Lavabo Quasar 65 monoforo vasca sinistra  
 Installazione sospesa  
 Quasar 65cm basin with left side bowl  
 1 tap hole. Wall mounted  
 Lavabo mono-trou vasque a' gauche  
 Installation suspendu  
 Waschbecken 65 cm mit Hahnloch  
 und Ablagefläche Links  
 Раковина 65 с одним отверстием левая

**QU 65S**

Lavabo Quasar 65 monoforo vasca sinistra  
 Quasar 65cm basin with left side bowl  
 1 tap hole

**QU 65D**

Lavabo Quasar 65 monoforo vasca destra  
 Quasar 65cm basin with right side bowl  
 1 tap hole



**QU 75S**

Lavabo Quasar 75 monoforo vasca sinistra. Installazione sospesa  
 Quasar 75 cm basin with left side bowl 1 tap hole. Wall mounted  
 Lavabo mono-trou vasque a' gauche. Installation suspendu  
 Waschbecken 75 cm mit Hanhloch und Ablagefläche Links  
 Раковина 75 с одним отверстием левая

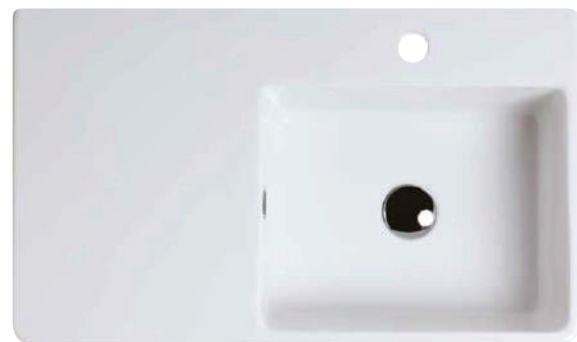
**QU 75D**

Lavabo Quasar 75 monoforo vasca destra  
 Quasar 75cm basin with right side bowl 1 tap hole

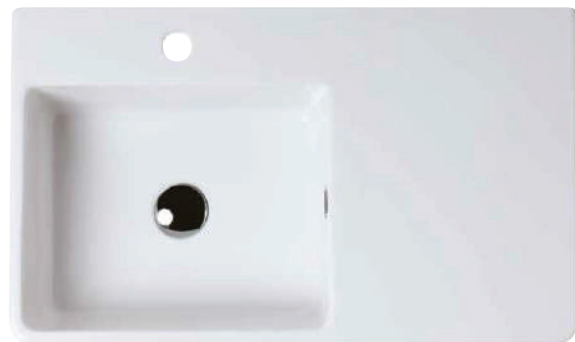
**QU 75S**

Lavabo Quasar 75 monoforo vasca sinistra  
 Quasar 75cm basin with left side bowl 1 tap hole

**TOP 60**

Consolle 105 "MONTECARLO"  
 Console 105 "MONTECARLO"  
 Console 105 "MONTECARLO"  
 Konsole 105 "MONTECARLO"  
 Консоль 105 "MONTECARLO"

**PAT 01**

Porta asciugamani frontale cromato  
 Chrome-finish anterior towel rail  
 Porte-serviettes frontal  
 Front-Handtuchhalter, verchromt  
 Фронтальная полка для полотенец, хром

**TOP 63**

Consolle 78 "SANREMO"  
 Console 78 "SANREMO"

**TOP 62**

Consolle 90 "NIZZA"  
 Console 90 "NIZZA"



**ACCESSORI DI COMPLETAMENTO**  
**ACCESSORIES AVAILABLE**

**PAT 01** Portasciugamani frontale  
 Anterior towel

**LU A11B** Coppia staffe di fissaggio per TOP 63/62/60  
 A pair of brackets for TOP 63/62/60

**S 52**

Lavabo ad incasso DESMO  
Fully inset washbasin DESMO  
Lavabo à encastrer DESMO  
Einbau-Waschtisch mit Einloch, DESMO  
Встроенный умывальник с одним отверстием,  
предусмотренный для трех отверстий DESMO

**S 51**

Lavabo ad incasso MONIA  
Fully inset washbasin MONIA

**S 50P**

Lavabo ad incasso MARINE  
Fully inset washbasin MARINE

**S 57**

Lavabo 67 semincasso PAOLA  
Semi inset washbasin 67 PAOLA  
Lavabo 67 à semi-encastrer PAOLA  
Halbeinbau-Waschtisch 67 PAOLA  
Полувстроенный умывальник PAOLA

**S 58**

Lavabo 56 semincasso UNI  
Semi inset washbasin 56 UNI

**S 59**

Lavabo 48 sottopiano  
Under-counter washbasin 48  
Lavabo sous étage 48  
Unterbauwaschbecken 48  
Умывальник, устанавливаемый ниже  
опорной поверхности 48

**S 60**

Lavabo 55 sottopiano  
Under-counter washbasin 55  
Lavabo sous étage 55  
Unterbauwaschbecken 55  
Умывальник, устанавливаемый ниже  
опорной поверхности 55

**S 53**

Lavabo sottopiano NEVADA  
 Under-counter washbasin NEVADA  
 Lavabo sous étage NEVADA  
 Unterbauwaschbecken NEVADA  
 Умывальник, устанавливаемый ниже опорной  
 поверхности NEVADA

**S 53**

Lavabo sottopiano NEVADA  
 Under-counter washbasin NEVADA

**S 54**

Lavabo sottopiano BLANCO  
 Under-counter washbasin BLANCO

**Q 500**

Lavello da cucina 75 da appoggio  
 Counter top kitchen sink 75  
 Evier 75 d'appui  
 Waschbecken 75, Aufsatz  
 Раковина 75 накладная



**ACCESSORI DI COMPLETAMENTO**  
**ACCESSORIES AVAILABLE**

**PLQ** Piletta di scarico inox con chiusura a pressione senza troppo pieno (1 ½ - 40 mm)  
 Inox pop-up waste drainer with 'shut-rapid' push system without overflow (1 ½ - 40 mm)

**DE 14**

kg 15

Lavabo 58 sospeso monoforo

*Wall hung washbasin 58 with single tap hole**Lavabo 58 suspendu mono trou**Hängendes 58-er Einloch – Waschbecken**Раковина 58 подвесная с одним отверстием***DE 13**

kg 22

Lavabo 60 sospeso monoforo

*Wall hung washbasin 60 with single tap hole**Lavabo 60 suspendu mono trou**Hängendes 60-er Einloch – Waschbecken**Раковина 60 подвесная с одним отверстием***DE 10**

kg 13

Lavabo 57 da appoggio

*Counter top washbasin 57**Lavabo 57 d'appui**Aufsatzwaschbecken 57**Раковина 57 накладная***BO 12**

kg 15

Lavabo 76 da appoggio predisposto monoforo

*Counter top washbasin 76 pre-punched for single tap hole**Lavabo 76 d'appui prédisposé mono trou**Aufsatzwaschbecken 76, für Einlocharmatur**Раковина 76 накладная с одним намеченным отверстием***GTE**

kg 37

Lavabo cilindrico predisposto monoforo

*Cylindrical washbasin pre-punched for single tap hole**Lavabo cylindrique mono trou**Waschtisch in Zylinderform mit Einloch**Умывальник цилиндрический, предусмотренный для одного отверстия***OH 10**

kg 17

Lavabo 60 da appoggio o sospeso predisposto monoforo

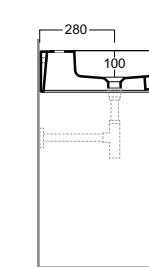
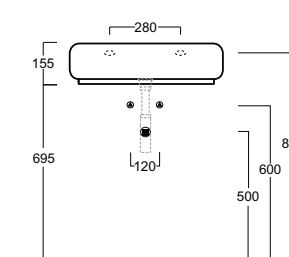
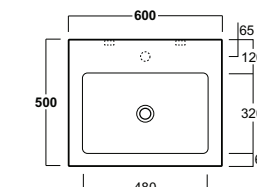
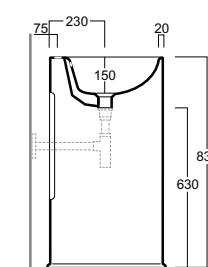
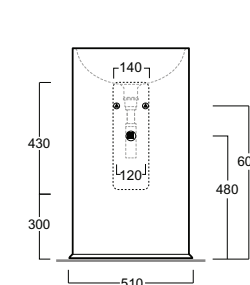
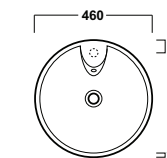
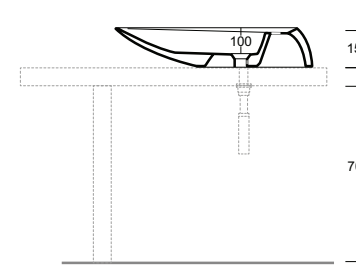
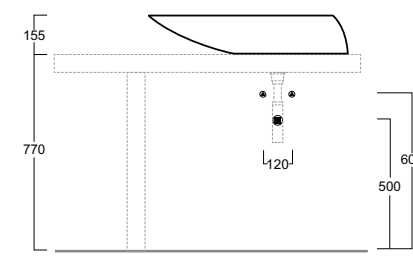
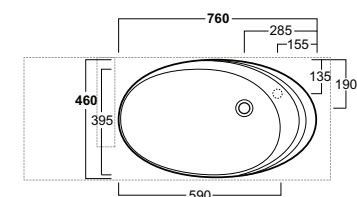
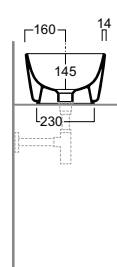
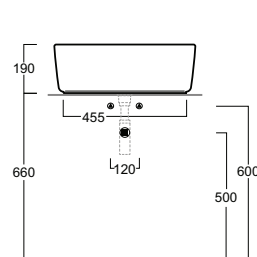
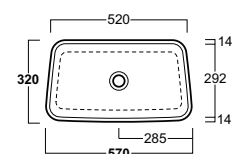
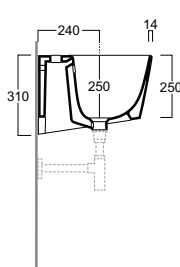
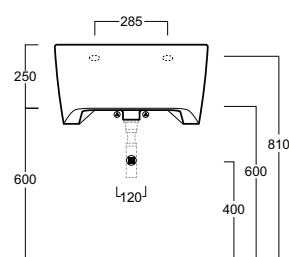
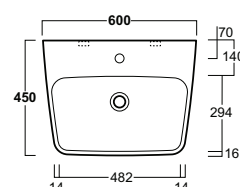
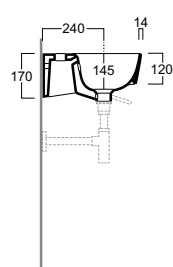
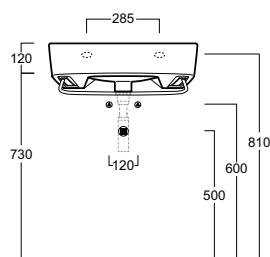
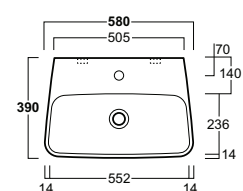
*Counter top or wall hung washbasin 60 pre-punched for single tap hole**Lavabo 60 d'appui ou suspendu prédisposé mono trou**Waschbecken 60, Aufsatz oder wandhängend, für Einlocharmatur**Раковина 60 накладная или подвесная с одним намеченным отверстием*

**OH 12**

kg 26

Consolle 90 da appoggio o sospesa  
predisposta monoforo

*Counter top or wall hung console 90 pre-punched  
for single tap hole*

*Console 90 d'appui ou suspendu prédisposée  
mono trou*

*Konsole 90, Aufsatz oder wandhängend,  
für Einlocharmatur*

*Консоль 90 накладная или подвесная с одним  
намеченным отверстием*

**QU 60D**

kg 19,5

Lavabo Quasar 60 monoforo vasca destra.  
Installazione sospesa

*Quasar 60cm basin with right side bowl  
1 tap hole. Wall mounted*

*Lavabo 60 mono-trou vasque a' droite.  
Installation suspendu*

*Waschbecken 60 cm mit Hahnloch und  
Ablagefläche Links. Wandhängend*

*Раковина 60 с одним отверстием правая*

**QU 60S**

kg 19,5

Lavabo Quasar 60 monoforo vasca sinistra.  
Installazione sospesa

*Quasar 60cm basin with left side bowl 1 tap hole.  
Wall mounted*

*Lavabo 60 mono-trou vasque a' gauche.  
Installation suspendu*

*Waschbecken 60 cm mit Hahnloch und  
Ablagefläche Rechts. Wandhängend*

*Раковина 60 с одним отверстием левая*

**QU 65D**

kg 20,3

Lavabo Quasar 65 monoforo vasca destra.  
Installazione sospesa

*Quasar 65cm basin with right side bowl  
1 tap hole. Wall mounted*

*Lavabo 65 mono-trou vasque a' droite.  
Installation suspendu*

*Waschbecken 65 cm mit Hahnloch und  
Ablagefläche Links. Wandhängend*

*Раковина 65 с одним отверстием правая*

**QU 65S**

kg 20,3

Lavabo Quasar 65 monoforo vasca sinistra.  
Installazione sospesa

*Quasar 65cm basin with left side bowl 1 tap hole.  
Wall mounted*

*Lavabo 65 mono-trou vasque a' gauche.  
Installation suspendu*

*Waschbecken 65 cm mit Hahnloch und  
Ablagefläche Rechts. Wandhängend*

*Раковина 65 с одним отверстием левая*

**QU 75D**

kg 22

Lavabo Quasar 75 monoforo vasca destra.  
Installazione sospesa

*Quasar 75cm basin with right side bowl  
1 tap hole. Wall mounted*

*Lavabo 75 mono-trou vasque a' droite.  
Installation suspendu*

*Waschbecken 75 cm mit Hahnloch und  
Ablagefläche Links. Wandhängend*

*Раковина 75 с одним отверстием правая*

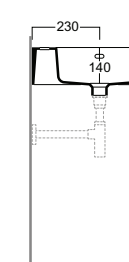
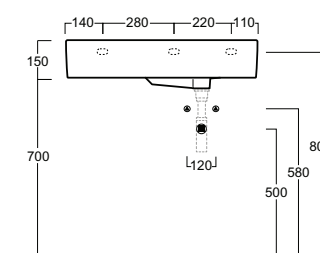
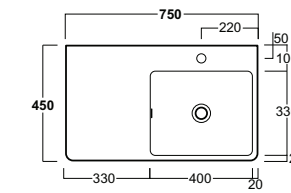
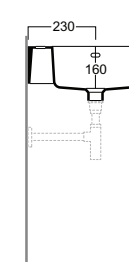
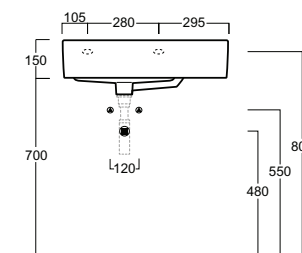
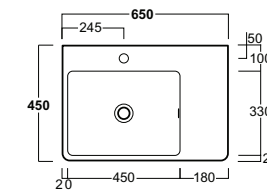
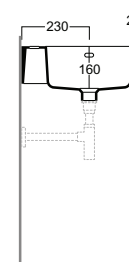
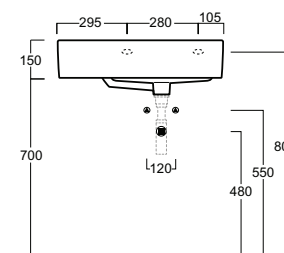
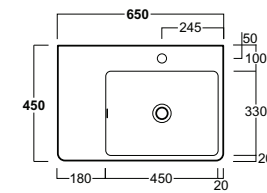
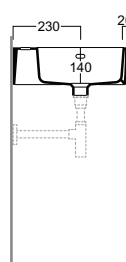
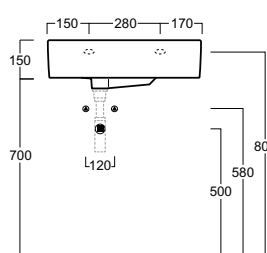
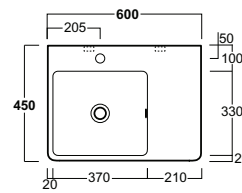
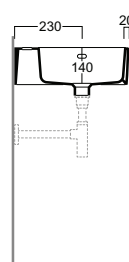
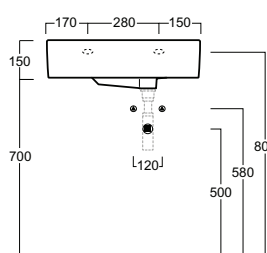
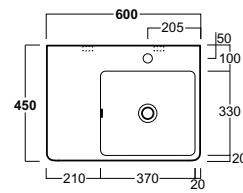
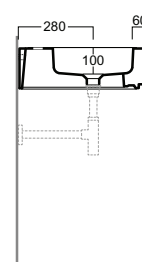
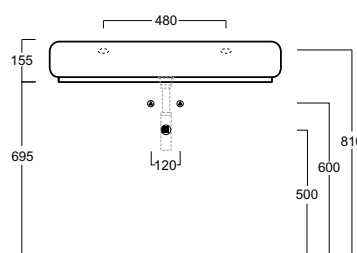
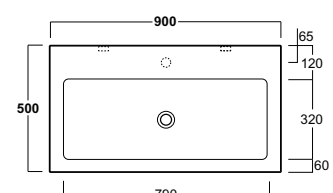

**QU 75S**

kg 22

Lavabo Quasar 75 monoforo vasca sinistra.  
Installazione sospesa

Quasar 75cm basin with left side bowl 1 tap hole.  
Wall mounted

Lavabo 75 mono-trou vasque a' gauche.  
Installation suspendu

Waschbecken 75 cm mit Hahnloch und  
Ablagefläche Rechts. Wandhängend

Раковина 75 с одним отверстием левая

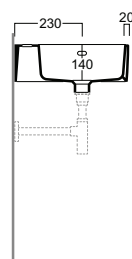
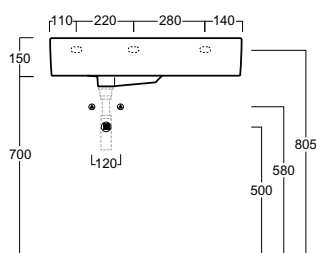
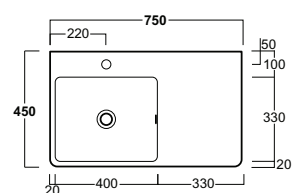
**TOP 63**

kg 19

Consolle 78 "SANREMO" monoforo predisposta  
per tre fori

Console 78 "SANREMO" with single tap hole pre-  
punched for three holes

Consolle 78 "SANREMO" mono trou prédisposée  
trois trous

Konsole 78 "SANREMO" mit Einloch, vorgebohrt  
für 3 Hahnlöcher

Консоль 78 "SANREMO" с одним отверстием,  
предусмотренная для трех отверстий

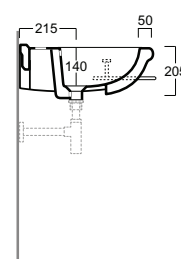
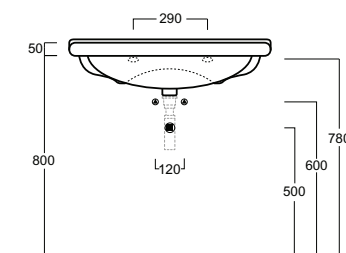
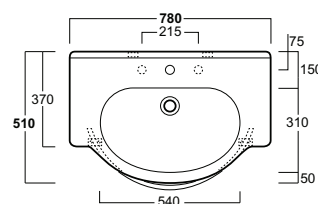
**TOP 62**

kg 22

Consolle 90 "NIZZA" monoforo predisposta  
per tre fori

Console 90 "NIZZA" with single tap hole pre-  
punched for three holes

Consolle 90 "NIZZA" mono trou prédisposée trois  
trous

Konsole 90 "NIZZA" mit Einloch, vorgebohrt für 3  
Hahnlöcher

Консоль 90 "NIZZA" с одним отверстием,  
предусмотренная для трех отверстий

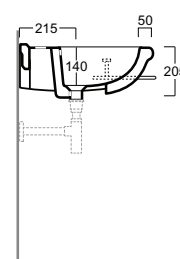
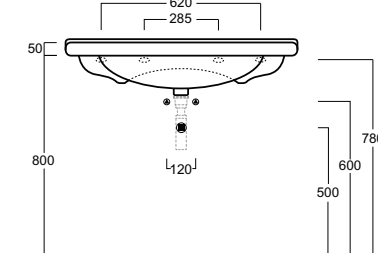
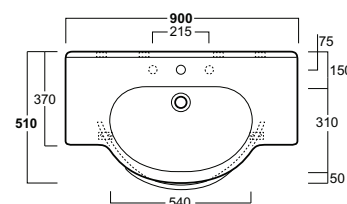
**TOP 60**

kg 24

Consolle 105 "montercarlo" monoforo  
predisposta per tre fori

Console 105 "MONTECARLO" with single tap  
hole pre-punched for three holes

Consolle 105 "Montercarlo" mono trou  
prédisposée trois trous

Konsole 105 "Montercarlo" mit Einloch,  
vorgebohrt für 3 Hahnlöcher

Консоль 105 "Montercarlo" с одним  
отверстием, предусмотренная для трех  
отверстий

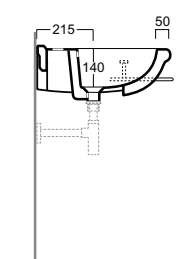
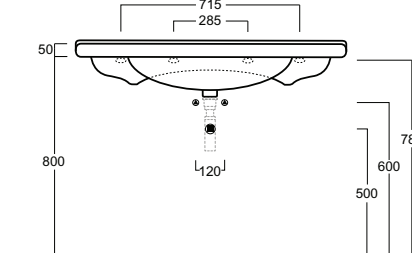
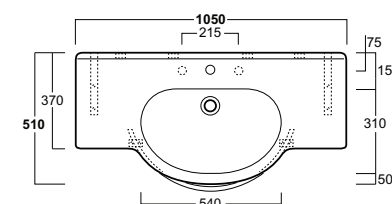
**PAT 01**

kg 1

Porta asciugamani frontale cromato  
per TOP 63/62/60

Chrome-finish anterior towel rail for TOP 63/62/60

Porte-serviettes frontal pour TOP 63/62/60

Front-Handtuchhalter, verchromt  
für TOP 63/62/60

Фронтальная полка для полотенец,  
хром, для соответственно TOP 63/62/60

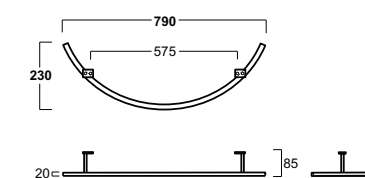
**LU A11B**

kg 2,8

Coppia staffe di fissaggio per TOP 63/62/60

A pair of brackets for TOP 63/62/60

Paire d'équerres de fixation pour TOP 63/62/60

Ein Paar Konsolen für Befestigung TOP 63/62/60

Пара крепежных скоб для TOP 63/62/60

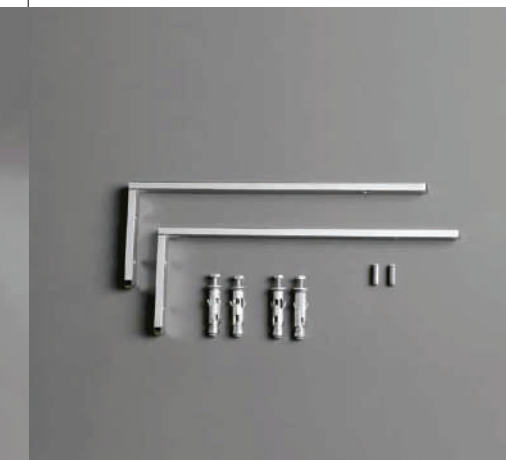

**S 50P**

kg 7

Lavabo ad incasso bordo piatto MARINE

*Fully inset washbasin with flat edge MARINE*

Lavabo à encastrer bord plat MARINE

Einbau-Waschtisch, flacher Rand MARINE

Встроенный умывальник с плоским бортиком MARINE

**S 51**

kg 13

Lavabo ad incasso monoforo predisposto per tre fori MONIA

*Fully inset washbasin with single tap hole pre-punched for three holes MONIA*

Lavabo à encastrer mono trou prédisposé trois trous MONIA

Einbau-Waschtisch mit Einloch, vorgebohrt für 3 Hahnlöcher MONIA

Встроенный умывальник с одним отверстием, предусмотренный для трех отверстий MONIA

**S 52**

kg 9

Lavabo ad incasso monoforo predisposto per tre fori DESMO

*Fully inset washbasin with single tap hole pre-punched for three holes DESMO*

Lavabo à encastrer mono trou prédisposé trois trous DESMO

Einbau-Waschtisch mit Einloch, vorgebohrt für 3 Hahnlöcher DESMO

Встроенный умывальник с одним отверстием, предусмотренный для трех отверстий DESMO

**S 53**

kg 8

Lavabo sottopiano NEVADA

*Under-counter washbasin NEVADA*

Lavabo sous étage NEVADA

Unterbauwaschbecken NEVADA

Умывальник, устанавливаемый ниже опорной поверхности NEVADA

**S 54**

kg 6

Lavabo sottopiano BLANCO

*Under-counter washbasin BLANCO*

Lavabo sous étage BLANCO

Unterbauwaschbecken BLANCO

Умывальник, устанавливаемый ниже опорной поверхности BLANCO

**S 57**

kg 17

Lavabo 67 semincasso monoforo predisposto per tre fori PAOLA

*Semi inset washbasin 67 with single tap hole pre-punched for three holes PAOLA*

Lavabo à semi-encastrer 67 mono trou prédisposé trois trous PAOLA

Halbeinbau-Waschtisch 67 mit Einloch, vorgebohrt für 3 Hahnlöcher PAOLA

Полувстроенный умывальник 67 с одним отверстием, предусмотренный для трех отверстий PAOLA

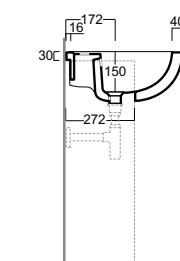
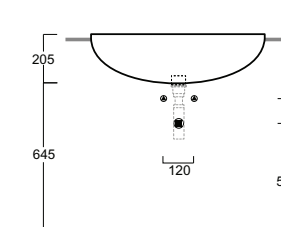
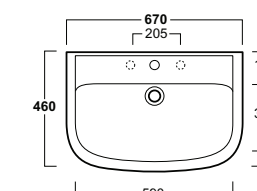
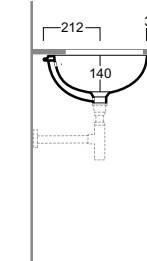
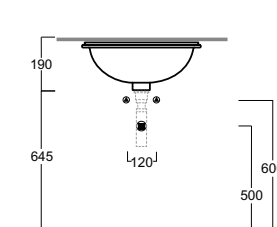
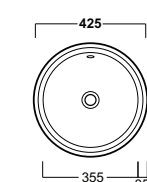
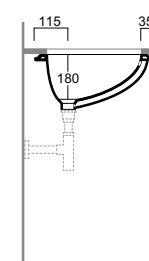
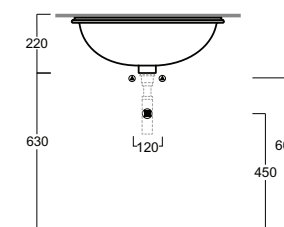
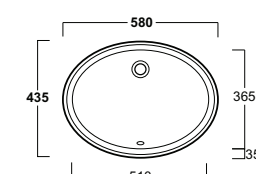
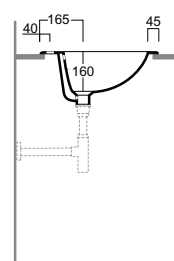
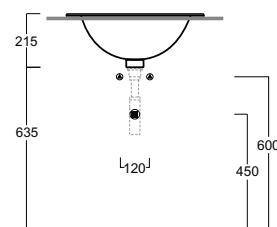
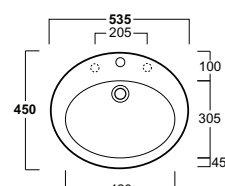
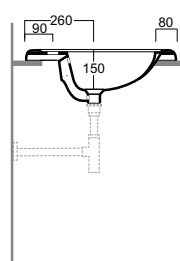
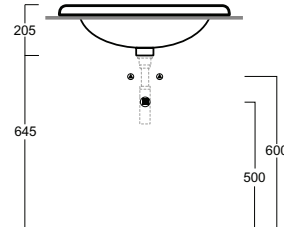
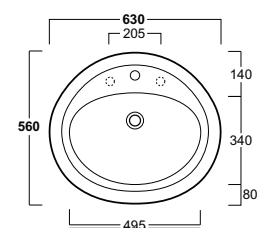
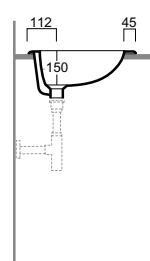
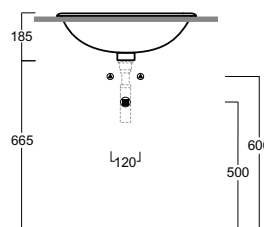
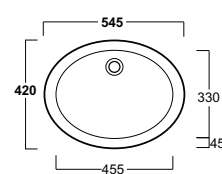



**S 58**

kg 12

Lavabo 56 semincasso monoforo predisposto per tre fori UNI

*Semi inset washbasin 56 with single tap hole pre-punched for three holes UNI*

*Lavabo 56 à semi-encastrer mono trou prédisposé trois trous UNI*

*Halbeinbau-Waschtisch 56 mit Einloch, vorgebohrt für 3 Hahnlöcher UNI*

*Полувстроенный умывальник 56 с одним отверстием, предусмотренный для трех отверстий UNI*

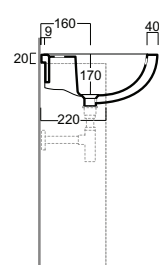
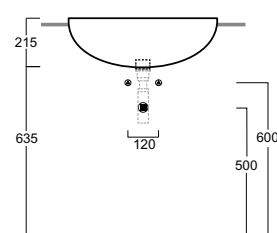
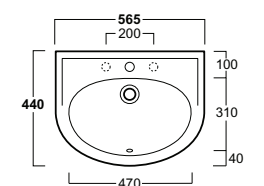
**S59**

kg 29

Lavabo 48 sottopiano

*Under-counter washbasin 48*

*Lavabo sous étage 48*

*Unterbauwaschbecken 48*

*Умывальник, устанавливаемый ниже опорной поверхности 48*

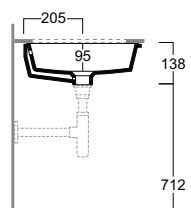
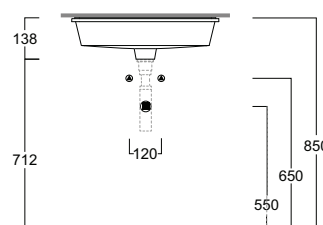
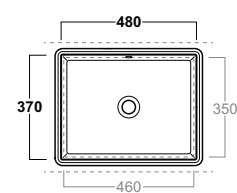
**S60**

kg 0,3

Lavabo 55 sottopiano

*Under-counter washbasin 55*

*Lavabo sous étage 55*

*Unterbauwaschbecken 55*

*Умывальник, устанавливаемый ниже опорной поверхности 55*

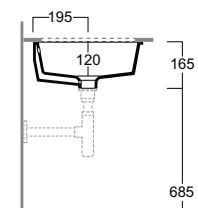
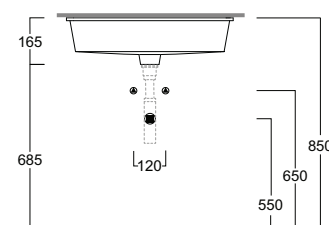
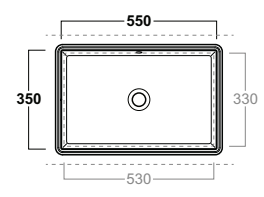
**Q 500**

kg 29

Lavello da cucina 75 da appoggio

*Counter kitchen sink 75*

*Evier 75 d'appui*

*Waschbecken 75, Aufsatz*

*Раковина 75 накладная*

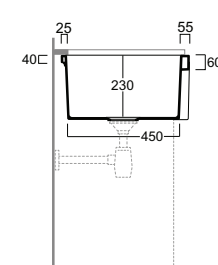
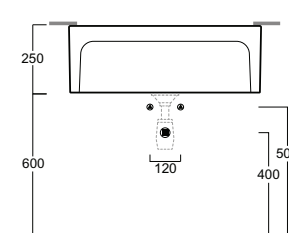
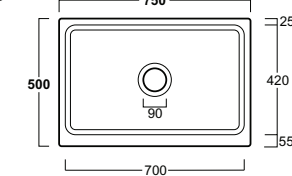
**PLQ**

kg 0,3

Piletta di scarico inox con chiusura a pressione senza troppo pieno (1 ½ - 40 mm)

*Inox pop-up waste drainer with 'shut-rapid' push system without overflow (1 ½ - 40 mm)*

*Bonde en inox avec fermeture à pression 'shut-rapid' sans trop plein (1 ½ - 40 mm)*

*Inoxabflusstoepsel mit 'shut-rapid' Verschluss ohne Ueberlauf (1 ½ - 40 mm)*

*Донный клапан из нержавеющей стали с закрытием под давлением без перелива (1 ½ - 40 мм)*

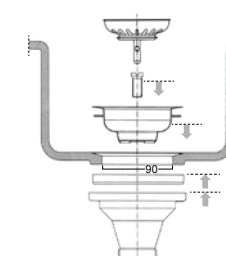

# piatti doccia H65

DESIGN: UFFICIO TECNICO

Soddisfano tutte le esigenze di spazio i piatti doccia in ceramica Simas. Di alta qualità, consentono di creare un ambiente bagno dove la parola benessere la fa da padrone. Dalle forme tradizionali (rettangolari e quadrati) e con un'altezza di 6,5 cm hanno l'antiscivolo integrato pur mantenendo un look elegante.

Simas's ceramic shower trays fulfil all needs of space. These high quality products make it possible to create bathrooms where well-being plays the main role. With traditional shapes – rectangular and square – and 6.5 cm high, they come with built-in non-slip surface and an elegant look.

Les bacs de douche en céramique Simas répondent à toutes les exigences de l'espace. De haute qualité, ils permettent de créer un espace salle de bains où le mot bien-être est de mise. Avec des formes traditionnelles (rectangulaires et carrées) et une hauteur de 6,5 cm, ils disposent d'une surface anti-dérapante intégrée tout en conservant une allure élégante.

Die Keramikduschwannen von Simas werden allen Raumanforderungen gerecht. Die hochwertigen Duschwannen tragen zur Gestaltung eines Badezimmers bei, in dem das Konzept der Wellness großgeschrieben wird. Sie überzeugen durch traditionelle (rechteckige und quadratische) Formen und bestechen bei 6,5 cm Höhe und integrierter Rutschfestigkeit durch ihren eleganten Look.

Высококачественные фаянсовые душевые поддоны Simas вписываются в любое пространство. Их высокое качество подчеркивает заботу о теле. Имеют традиционные формы (прямоугольные и квадратные), высота 6,5 см, функциональный антискользящий рельеф не нарушает изящества общего вида.



S 81 80x80x6,5



S 82 90x70x6,5



S 83 90x90x6,5



S 84 100x70x6,5



S 85 120x70x6,5



S 86 140x70x6,5



S 87 100x80x6,5



S 88 120x80x6,5

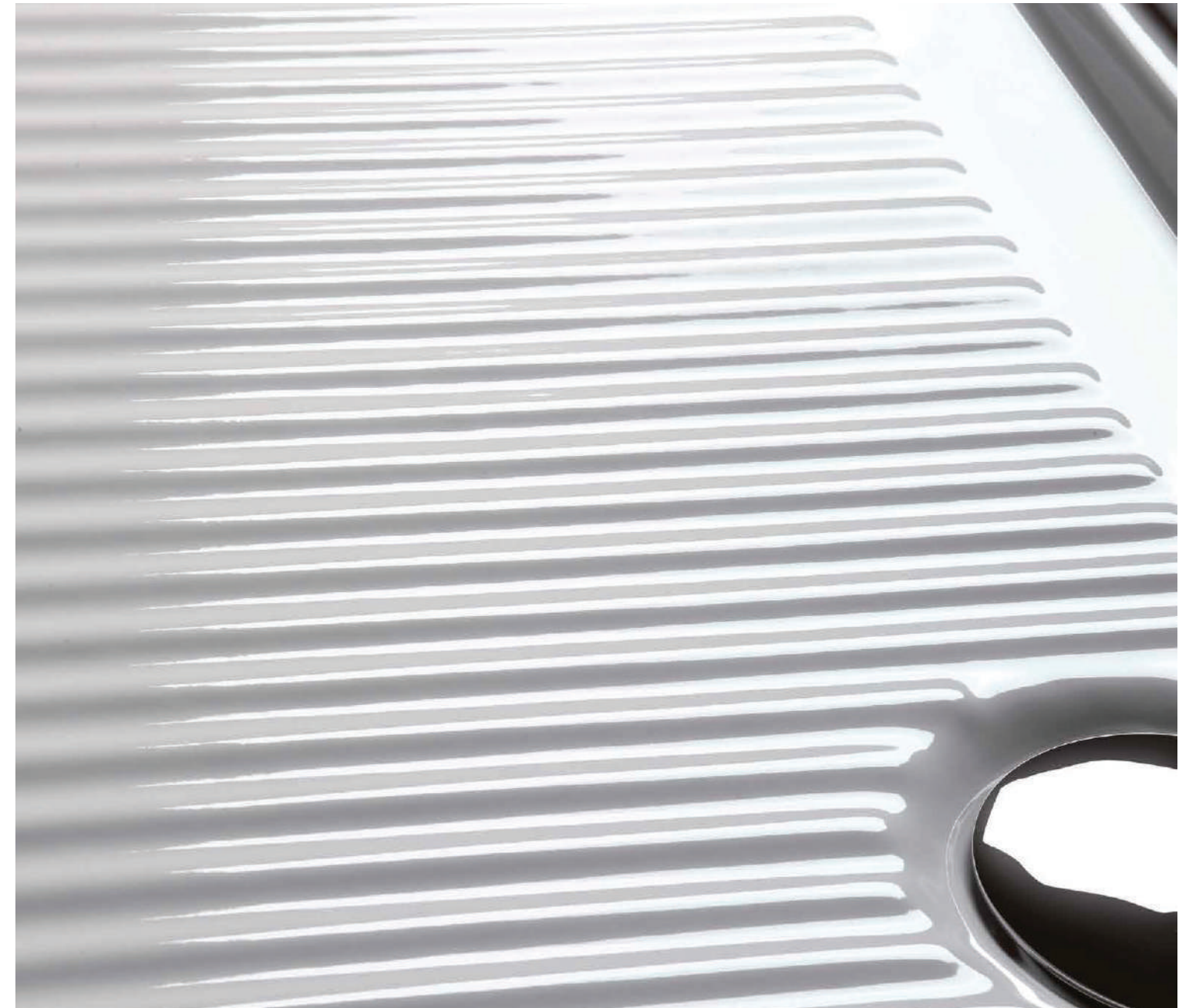

S 89 140x80x6,5

**S 88**

Piatto doccia 120x80 cm smaltato su tre lati  
 Shower tray 120x80 cm glazed on three sides  
 Bac à douche 120x80 cm sur les trois coté  
 Duschwanne 120x80 cm, dreiseitig beschichtet  
 Душевой поддон эмалированный с трех сторон 120x80 см



**ACCESSORI DI COMPLEMENTO**  
**ACCESSORIES AVAILABLE**

**PH6** Piletta per piatto doccia con tappo in plastica cromata  
 Shower waste with chromed plastic plug

**S 81** kg 30,5

Piatto doccia 80x80 cm smaltato su tre lati  
*Shower tray 80x80 cm glazed on three sides*  
*Bac à douche 80x80 cm sur les trois coté*  
*Duschwanne 80x80 cm, dreiseitig beschichtet*  
*Душевой поддон эмалированный с трех сторон 80x80 см*

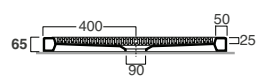
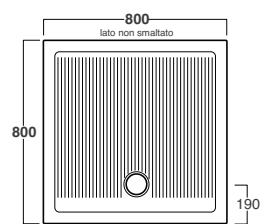
**S 82** kg 32

Piatto doccia 90x70 cm smaltato su tre lati  
*Shower tray 90x70 cm glazed on three sides*  
*Bac à douche 90x70 cm sur les trois coté*  
*Duschwanne 90x70 cm, dreiseitig beschichtet*  
*Душевой поддон эмалированный с трех сторон 90x70 см*

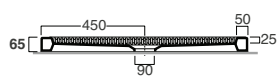
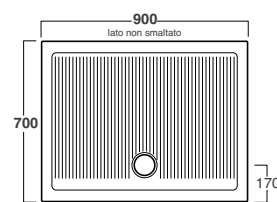
**S 83** kg 36,5

Piatto doccia 90x90 cm smaltato su tre lati  
*Shower tray 90x90 cm glazed on three sides*  
*Bac à douche 90x90 cm sur les trois coté*  
*Duschwanne 90x90 cm, dreiseitig beschichtet*  
*Душевой поддон эмалированный с трех сторон 90x90 см*

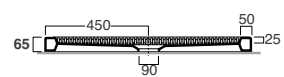
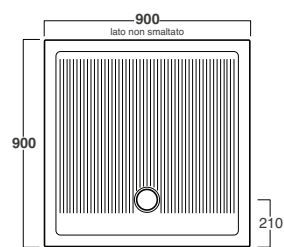
**S 84** kg 33

Piatto doccia 100x70 cm smaltato su tre lati  
*Shower tray 100x70 cm glazed on three sides*  
*Bac à douche 100x70 cm sur les trois coté*  
*Duschwanne 100x70 cm, dreiseitig beschichtet*  
*Душевой поддон эмалированный с трех сторон 100x70 см*

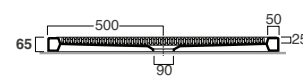
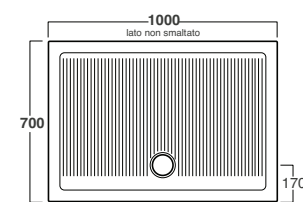
**S 85** kg 38

Piatto doccia 120x70 cm smaltato su tre lati  
*Shower tray 120x70 cm glazed on three sides*  
*Bac à douche 120x70 cm sur les trois coté*  
*Duschwanne 120x70 cm, dreiseitig beschichtet*  
*Душевой поддон эмалированный с трех сторон 120x70 см*

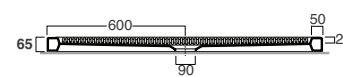
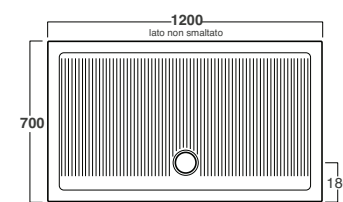
**S 86** kg 50

Piatto doccia 140x70 cm smaltato su tre lati  
*Shower tray 140x70 cm glazed on three sides*  
*Bac à douche 140x70 cm sur les trois coté*  
*Duschwanne 140x70 cm, dreiseitig beschichtet*  
*Душевой поддон эмалированный с трех сторон 140x70 см*

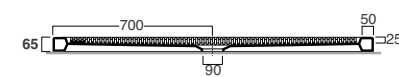
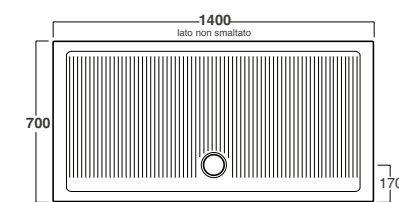

**S 87**

kg 36,5

Piatto doccia 100x80 cm smaltato su tre lati

*Shower tray 100x80 cm glazed on three sides**Bac à douche 100x80 cm sur les trois coté**Duschwanne 100x80 cm, dreiseitig beschichtet**Душевой поддон эмалированный с трех сторон 100x80 см***S 88**

kg 42,5

Piatto doccia 120x80 cm smaltato su tre lati

*Shower tray 120x80 cm glazed on three sides**Bac à douche 120x80 cm sur les trois coté**Duschwanne 120x80 cm, dreiseitig beschichtet**Душевой поддон эмалированный с трех сторон 120x80 см***S 89**

kg 50

Piatto doccia 140x80 cm smaltato su tre lati

*Shower tray 140x80 cm glazed on three sides**Bac à douche 140x80 cm sur les trois coté**Duschwanne 140x80 cm, dreiseitig beschichtet**Душевой поддон эмалированный с трех сторон 140x80 см***PH6**

kg 0,4

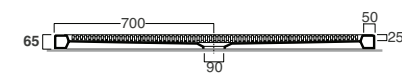
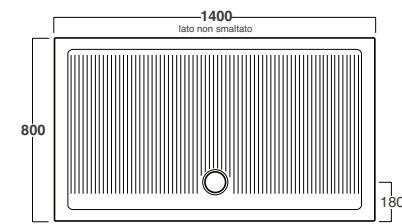
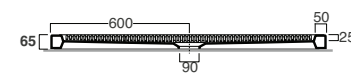
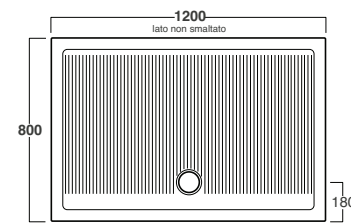
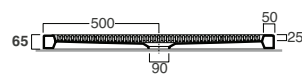
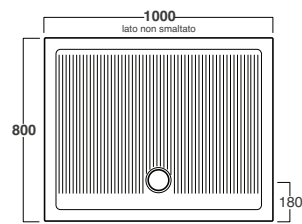
*Piletta per piatto doccia con tappo in plastica cromata**Shower waste with chromed plastic plug**Bonde pour receveur de douche avec bouchon en plastique chromé**Ablauf für Duschtasse mit Stöpsel in verchromtem Kunststoff**Сток для душевого поддона с пробкой из хромированного пластика*

# Colori disponibili

Available Colours / Couleurs disponibles / Erhältliche Farben / Возможные цвета

	BIANCO	NERO	CHAMPAGNE	BIANCO matt	NERO matt	ANTRACITE matt	CEMENTO matt	TELA matt	PERVINCA matt	NAVY matt	MIRTO matt	PRUGNA matt	MOKA matt	SABBIA matt
E-LINE	○													
LFT SPAZIO	○	●		○		●								
VIGNONI	○	●		○	●	●	●	●						
BADEN BADEN	○	●		○	●	●	●	●						
FLOW	○	●		○		●								
FROZEN	○	●												
SHARP	○	●	●	○	●	●	●	●	●	●	●	●	●	●
ARCADE	○	●	●											
LANTE	○	●	●											
LONDRA	○	●	●											
EVOLUTION	○	●												
LAV. D'ARREDO	○	●		○		●								
PIATTI DOCCIA	○													

## Colorati - ceramiche

Per i sanitari in ceramica colorati (colori brillanti e matt) deve essere considerata una maggiorazione del 35% dal prezzo del bianco

A price increase of 35% on the price of white to be added for the colored ceramics sanitary ware (brilliant and matt colors)

Une majoration du prix du blanc de 35% est à considérer pour les sanitaires en céramiques en couleurs brillantes e mates

Ein Aufpreis von 35% im Vergleich zur weissen gilt für alle die Keramischen Sanitaranlagen aus glanzten und matten Farben

## Цветная керамика

Для цветной керамики (глянцевые и матовые цвета) необходимо учитывать увеличение на 35% относительно цены белого изделия

## Colorati - sedili

Per i sedili colorati deve essere considerata una maggiorazione del 35% per i colori brillanti e una maggiorazione del 50% per i colori matt rispetto al prezzo del bianco

A price increase of 35% for brilliant color seat covers and of 50% for matt color seat covers is to be added with respect to the price of white

Une majoration du prix du blanc de 35% pour les abattants en couleur brillant et de 50% pour les abattants en couleur mat est à considérer

Ein Aufpreis von 35% im Vergleich zur weissen gilt für alle die WC-Deckeln aus glanzten Farben und von 50% im Vergleich zur weissen für alle die WC-Deckeln aus matten Farben

## Цветные сиденья

Для цветных сидений необходимо учитывать увеличение на 35% для глянцевого цвета и 50% для матового цвета относительно цены белого изделия

Le tonalità dei colori sono da ritenersi indicative, in quanto possono variare in relazione alle modalità di stampa.

The colour tones are indicative, as they may change in relation to the printing method.

Les tonalités des couleurs sont indicatives et peuvent varier en fonction des modes d'impression

Die Tonart der Farben sind Richtfarben und können unterschiedlich sein nach die verschiedenen Drucksysteme.

Приведенные цвета являются ориентировочными, что связано с полиграфическими параметрами печати.

# Essenze e finiture mobili

Wood and furniture finishing / Bois et finitions / Essenzen und Oberflächenbeschichtungen der Möbel Holz

## Legno

Wood / Bois / Hochglanz / Дерево

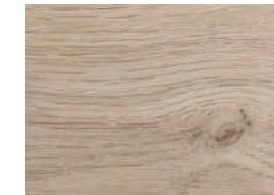

Vignoni  
Rovere Chiaro  
Light Oak  
Chêne Clair  
Klar Eiche  
светлый дуб



Frame  
Rovere Scuro  
Dark Oak  
Chêne Foncé  
Dunkle Eiche  
Темный дуб



Frame  
Frassino Grigio  
Grey Ashwood  
Frêne Gris  
Graue Esche  
серый ясень

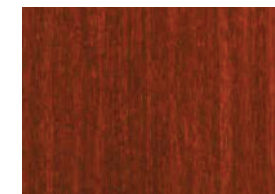

Arcade  
Massello di betulla - finitura noce  
Birch solid wood - walnut finish  
Bouleau massif - finition noyer  
Massive Birke - Nussbaum beschichtet  
Массив березы - цвет орех

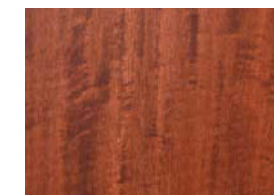

Vasche  
Touliplier - finitura bianco laccato - finitura noce  
Touliplier - white lac finish - walnut finish  
Tulipier - finition laque blanche - finition noyer  
Touliplier - weiß lackiert - Nussbaum  
Тулипьер - цвет - белый лак - орех

## Laccati

Lacquered / Fini laqué / Lackierung / Лакокрасочные покрытия



Vignoni  
Bianco Opaco  
Matte White  
Blanc Mat  
Matt weiß  
белый матовый



Vignoni  
Antracite Opaco  
Matte Anthracite  
Anthracite mat  
Anthrazit matt  
матовый антрацит



Frame  
Bianco Opaco  
Matte White  
Blanc Mat  
Matt weiß  
белый матовый



Arcade  
Massello di betulla - finitura bianco  
Birch solid wood - white finish  
Bouleau massif - finition blanc  
Massive Birke - Weiß beschichtet  
Массив березы - цвет белый лак



Lante  
Massello di betulla - finitura bianco  
Birch solid wood - white finish  
Bouleau massif - finition blanc  
Massive Birke - Weiß beschichtet  
Массив березы - цвет белый лак

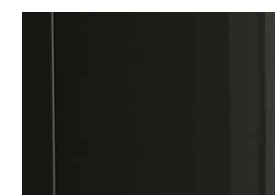

Lante  
Massello di betulla - finitura nero  
Birch solid wood - black finish  
Bouleau massif - finition noir  
Massive Birke - Schwarz beschichtet  
Массив березы - цвет черный лак

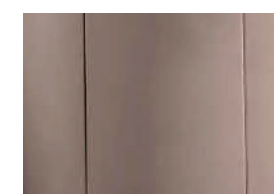

Lante  
Massello di betulla - finitura tortora  
Birch solid wood - dove grey finish  
Bouleau massif - finition tourterelle  
Massive Birke - Grau / Taupe beschichtet  
Массив березы - цвет tortora

# Finiture Accessori Victoria

Available finishing / Finitions disponibles / Feinbearbeitungen auf Anfrage / Имеющиеся в наличии цвета

1. CROMO  
Chrome  
Chrome  
Chrom  
Хром

2. ORO  
Gold  
Doré  
Gold  
Золото

3. BRONZO  
Bronze  
Bronze  
Bronze  
Бронза

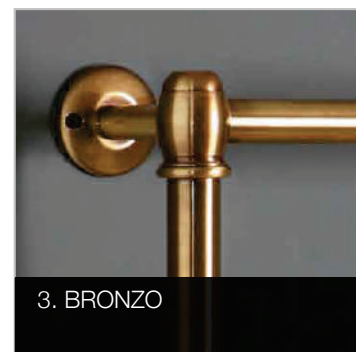
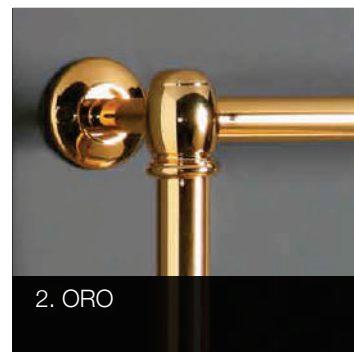

# Note

Notes / Notes / Anmerkungen / Примечания

## INFORMAZIONI PER INSTALLAZIONE DI SANITARI SOSPESI

Tutti i prodotti indicati per installazione sospesa hanno superato i test di riferimento. Si garantisce quindi l'installazione sospesa se montati su pareti sufficientemente strutturate e comunque idonee al carico.

## INFORMATION FOR INSTALLING SUSPENDED PRODUCTS

All of our products are suitable for suspension and have passed all the relevant tests. Safe installation of suspended products is guaranteed when they are mounted on walls with an appropriate structure that are strong enough to support the weight of the installation.

## INFORMATION POUR L'INSTALLATION DE SANITAIRES SUSPENDUS

Tous les produits indiqués pour l'installation suspendue ont passé les tests de référence avec succès. On garantit par conséquent l'installation suspendue sur cloisons suffisamment structurées et de toute façon aptes à la charge.

## INFORMATIONEN ZUR INSTALLATION FÜR HÄNGENDE PRODUKTE

Alle aufgeführten Produkte für hängende / Wandmontage haben die Referenztests bestanden. Dadurch wird gewährleistet, dass die Wandmontage wenn an den zu montierenden Wänden eine gute Struktur gegeben ist, diese die Last trägt.

## “ИНФОРМАЦИЯ ПО УСТАНОВКЕ ПОДВЕСНЫХ ИЗДЕЛИЙ”

Все артикулы, предназначенные для подвесной установки, прошли соответствующие испытания. Таким образом, гарантируется подвесная установка при условии монтажа на стены, специально для этого обработанные и подготовленные для нагрузки.

# Condizioni Generali di Vendita

- 1) Consegna:** La merce è venduta franco ns. stabilimento. La SIMAS S.p.A. si riserva la facoltà di evadere un ordine in piu consegne a secondo delle effettive disponibilità dei prodotti presso il proprio magazzino.
- 2) Imballaggi:** Le caratteristiche dell'imballaggio saranno esclusivamente a scelta della SIMAS S.p.A. che ne farà oggetto di addebito in fattura al Cliente,
- 3) Dimensioni e pesi:** Le dimensioni ed i pesi riportati nel presente listino sono da intendersi a titolo puramente indicativo.
- 4) Termini di consegna:** I termini di consegna e spedizione hanno valore indicativo in quanto, anche se il programma di consegne sarà improntato tenendo conto delle richieste del Cliente, la SIMAS S.p.A. si riserva di apportare modifiche alle sequenze delle consegne stesse rispetto ai programmi concordati.
- 5) Pagamenti:** I termini di pagamento si intendono tassativi e decorrono dalla data di fatturazione. La SIMAS S.p.A. si riserva la facoltà di sospendere od annullare forniture qualora i pagamenti non siano effettuati nei termini pattuiti. Ogni eventuale contestazione non dà diritto al Cliente di sospendere i pagamenti in corso.
- 6) Interessi di mora:** L'inosservanza dei termini di pagamento stabiliti determinerà l'addebito al Cliente degli interessi di mora al tasso ufficiale di sconto aumentato di 5 punti.
- 7) Caratteristiche tecniche:** La SIMAS S.p.A. si riserva la facoltà, in qualsiasi momento, di modificare le caratteristiche tecniche dei propri prodotti nonché di modificare o sopprimere modelli.
- 8) Reclami:** Tutte le forniture effettuate si intendono accettate trascorsi, senza alcun reclamo, 8 giorni dal ricevimento della merce. Eventuali reclami dovranno essere inoltrati, entro il suddetto termine, a mezzo raccomandata direttamente alla Sede della SIMAS S.p.A.
- 9) Foro competente:** Qualsiasi controversia sarà di esclusiva competenza del foro di Viterbo.

# General Sales Terms

- 1) Delivery:** Goods are sold ex factory. SIMAS S.p.A. reserves the right to carry out orders in more than one shipment depending on stock availability.
- 2) Packing:** Packing will be chosen by SIMAS S.p.A. and will be invoiced to clients.
- 3) Dimensions and weights:** Dimensions and weights as indicated in the present price-list are to be considered as approximate ones.
- 4) Delivery terms:** Delivery and shipment terms are approximate since, even though shipping schedules are organised to meet clients' needs, SIMAS S.p.A. reserves the right to modify delivery sequences regardless of agreed terms.
- 5) Payments:** Payment terms must be strictly respected starting from invoice date. SIMAS S.p.A. reserves the right to stop or cancel shipments in case of clients' failure to pay within agreed terms. Any controversy does not give clients the right to stop pending payments.
- 6) Arrears interest:** In case the client fails to settle payments within agreed terms, the client will be charged arrears interest at the current discount rate increased by 5 points.
- 7) Technical features:** At any time, SIMAS S.p.A. reserves the right to modify technical features of its products as well as modify or cancel any model.
- 8) Complaints:** Any consignment will be considered as accepted after 8 days upon receipt of goods. After that, complaints will not be taken into consideration. Complaints must be forwarded within the a.m. term by registered mail directly to SIMAS S.p.A.
- 9) Relevant Court:** Any controversy falls within the competence of the Viterbo Court.

# Conditions Générales de Vente

- 1) Livraison:** Les marchandises sont vendues franco notre usine. SIMAS S.p.A. se réserve la faculté d'exécuter une commande en plusieurs tranches en fonction des disponibilités effectives des produits en stock.
- 2) Emballage:** Les caractéristiques de l'emballage seront exclusivement déterminées par SIMAS S.p.A. et les frais correspondants seront reportés sur la facture remise au client.
- 3) Dimensions et poids:** Les dimensions et les poids indiqués sur ce catalogue sont fournies à titre purement indicatif.
- 4) Délais de livraison:** Les délais de livraison et d'expédition sont fournis à titre indicatif car, même si le programme de livraison sera établi en tenant compte des exigences du Client, SIMAS S.p.A. se réserve cependant d'apporter des modifications aux programmes de livraisons par rapport aux planifications concordées.
- 5) Paiements:** Les délais de paiement sont impératifs et calculés à partir de la date de facturation. SIMAS S.p.A. se réserve la faculté de suspendre ou d'annuler des fournitures si les paiements ne sont pas effectués dans les délais impartis. Toute contestation éventuelle ne donne pas droit au Client de suspendre les paiements en cours.
- 6) Intérêts moratoires:** Le non-respect des délais de paiement fixés entraînera le débit au Client des intérêts moratoires au taux d'escompte officiel plus 5 points.
- 7) Caractéristiques techniques:** SIMAS S.p.A. se réserve la faculté, à tout moment, de modifier les caractéristiques techniques de ses produits de même que de modifier ou supprimer ses modèles.
- 8) Réclamations:** Toutes les fournitures effectuées seront considérées comme acceptées dès lors qu'aucune réclamation n'aura été avancée dans un délai de 8 jours à compter de la date de réception des marchandises. Toute réclamation éventuelle devra être adressée, d'ici l'expiration de ce délai, par lettre recommandée directement au siège de SIMAS S.p.A.
- 9) Tribunal compétent:** Tout différend éventuel relèvera de la compétence exclusive du Tribunal de Viterbo.

# Allgemeine Verkaufsbedingungen

- 1) Lieferung:** Die Ware wird frei ab Werk verkauft. SIMAS S.p.A. behält sich das Recht vor, je nach Produktverfügbarkeit im Lager eine Bestellung auf mehrere Lieferungen aufzuteilen.
- 2) Verpackung:** Die Wahl der Eigenschaften der Verpackung obliegt ausschließlich SIMAS S.p.A. Die Verpackung geht zu Lasten des Kunden und ist in der Rechnung angeführt.
- 3) Abmessungen und Gewicht:** Die in dieser Liste angeführten Gewichtsangaben und Abmessungen gelten lediglich als Richtwerte.
- 4) Lieferfristen:** Die Liefer- und Versandfristen stellen ungefähre Werte dar. Auch wenn die Lieferung den Wunsch des Kunden berücksichtigt, behält sich SIMAS S.p.A. das Recht vor, Änderungen der Lieferzeiten vorzunehmen.
- 5) Zahlung:** Die Zahlungsfristen sind strikt einzuhalten und gelten ab Rechnungsdatum. SIMAS S.p.A. behält sich das Recht vor, Lieferungen einzustellen oder zu streichen, sollte die Zahlung nicht innerhalb der vereinbarten Frist erfolgt sein. Beanstandungen seitens des Kunden geben diesem nicht das Recht, die Zahlungen einzustellen.
- 6) Verzugszinsen:** Die Nichteinhaltung der Zahlungsfristen führt zur Zahlung der Verzugszinsen durch den Kunden, die in diesem Fall um 5 Prozent gegenüber dem offiziellen Satz erhöht werden.
- 7) Technische Eigenschaften:** SIMAS S.p.A. behält sich das Recht vor, jederzeit die technischen Eigenschaften der Produkte und Modelle zu ändern sowie die Produktion von bestimmten Modellen einzustellen.
- 8) Beanstandungen:** Alle Lieferungen sind nach 8 Tagen ab Lieferung ohne Beanstandung als angenommen anzusehen. Etwaige Beanstandungen sind innerhalb der oben genannten Frist per Einschreiben an den Sitz der SIMAS S.p.A. zu richten.
- 9) Gerichtsstand:** Jeglicher gerichtliche Streitfall obliegt der Zuständigkeit des Gerichtstands von Viterbo.



# Общие условия продажи

**1) Поставка:** Товар продается на условиях франко склад. SIMAS S.p.A. оставляет за собой право поставки заказа в несколько этапов в зависимости от наличия товаров на складе фабрики.

**2) Упаковка:** вид упаковки будет полностью определяться выбором фабрики, стоимость услуг по упаковке товара будет выставлена Клиенту отдельно в инвойсе.

**3) Веса и размеры:** Веса и размеры, приведенные в данном прайс-листе являются ориентровочными.

**4) Сроки поставки:** Сроки поставки и отправки товара являются также ориентировочными, SIMAS S.p.A. оставляет за собой право вносить изменения в порядок поставок.

**5) Оплата:** Условия оплаты являются четко определенными и вступают в силу с момента выставления счета. SIMAS S.p.A. имеет право приостановить или аннулировать поставку в случае несвоевременной оплаты. Любой спор, возникающий по этому вопросу, не дает Клиенту права приостанавливать текущие платежи.

**6) Неустойка:** Несоблюдение установленных сроков оплаты влечет за собой начисление на счет Клиента неустойки в виде уменьшения скидки на 5 %.

**7) Технические характеристики:** SIMAS S.p.A. имеет право в любой момент изменить технические характеристики собственных изделий, а также изменить или снять с производства артикулы.

**8) Рекламации:** Все поставки считаются принятыми по прошествии 8 дней с момента получения груза Клиентом, если в течение этого срока не было предъявлено рекламаций. Рекламации должны быть предъявлены в течение данного срока в виде заказного письма на адрес Simas S.p.A.

**9) Арбитраж:** Любые споры будут рассматриваться Арбитражным судом г. Витербо.

## Garanzia / Warranty

SIMAS garantisce da eventuali difetti di fabbricazione tutti i prodotti a catalogo per un periodo di due anni dalla consegna. La garanzia consiste nella sola sostituzione del pezzo difettoso, posto che lo stesso sia stato installato ed utilizzato correttamente, in conformità allo standard applicabile e alle istruzioni di montaggio, uso e manutenzione fornite. Sono escluse dalla presente garanzia le parti usurabili (componenti in plastica o gomma, guarnizioni etc.) e gli eventuali costi aggiuntivi derivanti dalla messa in opera del pezzo sostituito e dal trasporto.

*SIMAS grants a guarantee period of two years since the date of delivery of all the products in the catalogue. SIMAS assumes no obligation other than the replacement of defective part upon presentation along with proof of purchase, providing that the product has been in accordance with the SIMAS operating instructions and with the current plumbing practice properly installed, used and serviced. Consumable articles (rubber elements, gaskets etc.) are not covered by this warranty, as well as labor, shipping and duty charges.*

GENERAL CATALOGUE  
2018

**ART DIRECTION**

FEDERICA ASCHI, STUDIO21

**PHOTOGRAPHY**

FABRIZIO FAEDDA, STUDIO21

**ALLESTIMENTI SCENOGRAFICI**

EMILIANO ORLANDINI, STUDIO21

**RENDER:**

37LAB

**PR OFFICE + TEXTS**

STUDIO PENISOLA, MILANO

T. +39 02 55187724

MAIL: INFO@STUDIOPENISOLA.IT

**SPAZIO SIMAS**

VIA MELZO 9, MILANO

T. +39 02 20229822

CONTACT: CRISTINA SCHIAVON

**SPECIAL THANKS TO:**

BROKIS LAMPADE, DIESEL

WITH FOSCARINI, FLOS,

GORLAN CARPET, IB RUBINETTERIE,

KARTELL, MUUTO, POLIFORM,

TOM DIXON, ZETTEL.

**PRINT**

TELLIGRAF SRL

PRINTED IN ITALY

SEPTEMBER 2018

**SIMAS SPA**

VIA FALERINA KM 3

01033 CIVITA CASTELLANA

(VITERBO) ITALY

T +39 0761 518161

F +39 0761 517897

SIMAS@SIMAS.IT

I dati e le caratteristiche indicate nel catalogo. Simas spa si riserva il diritto di apportare le eventuali modifiche ritenute opportune senza obbligo di preavviso o di sostituzione.

The information and characteristics indicated in the catalogue. Simas S.p.A. is entitled to carry out modifications deemed necessary without the obligation of previous notice or replacement.

Caractéristiques disponibles sur catalogue. Simas spa se réserve le droit d'apporter d'éventuelles modifications sans préavis ni remplacement.

Daten und Merkmale sind im Katalog aufgeführt. Simas spa behält sich nach eigenem Ermessen etwaige Änderungen vor, ohne zur Vorankündigung oder zum Austausch verpflichtet zu sein.

Технические характеристики указаны в каталоге. Simas spa оставляет за собой право изменять ассортимент продукции без предварительного извещения покупателей и не обязуется заменять изделие в случае расхождения с каталогом.

