

Beautifully Traditional Bathrooms

Burlington[®]



contents

CERAMICS

There are four eras of history reflected in our designs; Classic, Edwardian, Victorian and Contemporary. Within each of these designs there are sizes to suit your bathroom, shower room or cloakroom. A selection of WCs and bidets are available to match your washbasin selection.

Introduction	4
Classic	10
Edwardian	20
Victorian	24
Contemporary	28
Stone	32
Cloakroom	36
WC's	40

FURNITURE

A range of beautifully traditional furniture solutions to add classic style and sophisticated British elegance to your bathroom. Choose from free-standing, either a square or round design, wall-hung or fully-fitted options.

Introduction	74
Cloakroom	76
650 Units	80
1300 Units	86
1340 Units	90
1000 Units	96
Fitted	102
Baths	108
Worktops	114

BATHS

Our range of baths includes grand free-standing baths, roll top baths and standard baths. Roll top baths have a range of matching feet and the Hampton roll top is even designed to fit into a corner, fitting a modest size bathroom.

Introduction	116
Double Ended	118
Single Ended	130
Showering	142

BRASSWARE

Burlington taps and mixers bring classic design packed with innovative technology. There are separate taps, one and three piece basin mixers, an Arch fitting and bath fittings with telephone handsets, each with a choice of handles.

Introduction	148
Black Indice Introduction	154
Basin Taps	156
Bath Taps	158
Thermostatic	160
Stafford	162
Chelsea	164
Sundry & Wastes	166

SHOWERING

Shower mixers with modern safe thermostatic control are the way forward for controllable showering, and a period enclosure can complete your bathroom.

Introduction	168
Showers & Valves	170
Enclosures	178
Digital	186

ACCESSORIES

The look is complete with stunning chrome plated solid brass accessories. From corner baskets for your shower, to soap dispensers, they provide the perfect finishing touch to your bathroom.

Introduction	196
Accessories	198
Radiators	202
Mirrors	204
Lights	206

ARCADE

Introducing Arcade's range of exquisitely crafted bathroom pieces, lovingly designed to create a decor that is truly unique.

Introduction	208
Iconic	212
Ceramics	218
WCs	224
Baths	226
Brassware	238
Showering	248
Accessories	252

Introducing

burlington bathrooms

From the late 1800's into the 1900's Britain led the way in bathroom design and performance. Burlington Bathrooms brings a complete collection of traditional bathroom products for you to create a classical British bathroom from these eras of great design.

By offering genuine past designs with modern functionality, the designs within the product portfolio reflect the traditional eras ranging from Edwardian, Victorian, Classic and Contemporary. The Burlington product portfolio is designed and made to suit the requirement of any bathroom design; residential or projects.

The latest technology can also be found throughout the Burlington products including but not limited to Digital showering, thermostatic showering and Nano Glaze.

Our range is extensive and allows you to create your own look and feel to suit your personal choice, safe in the knowledge that these are designed to co-ordinate together perfectly.





Ceramics

There are a great variety of options within the Burlington collection. Choose from the simply styled Classic collection in either a round or square design, the Edwardian basin with its subtle angular appearance, again in a round or square design, Victorian with a refined look or Contemporary for a minimal and pared back form.

Basins are available in one, two or three tap hole options and can be used on a variety of styled pedestals; either standard, regal, semi pedestal, washstand or countertop options.

WC's are available as close coupled, low, medium or high level and both wall hung and back to wall options. There are also Regal WC's offering a higher seating position throughout the range and a new addition of a Rimless WC.



Basins



Standard

Regal

Our Burlington basins can be paired with a standard or Regal pedestal option. The Regal options are 60mm taller than the standard and are available throughout the range of full pedestals in Classic, Victorian, Edwardian and Contemporary.

Within the washstand collection, we also offer the taller option, meaning that all basins can be used at a more comfortable height for those who wish.



PEDESTAL OPTIONS

Available with the Classic & Classic Round basins

Burlington Regal pedestals are 60mm higher than the standard pedestals.

	Standard Height	Regal Height
Classic	840mm	920mm
Victorian	840mm	900mm
Edwardian	840mm	900mm
Contemporary	840mm	900mm



Standard



Regal

WASHSTAND OPTIONS

Available with the Classic, Edwardian, Victorian and Cloakroom basins

Burlington Regal washstands are 60mm higher than the standard washstand to ensure a more ergonomic use for taller individuals.



Standard



Regal

Basins

Burlington Bathroom design is governed largely by the washbasin style. Every design is crafted to reflect the specific era in which British sanitaryware rose in fame and was heralded as the best in aesthetic and performance. Burlington's key design themes are represented through Classic, Edwardian, Victorian and Contemporary eras. Every basin is crafted to the highest quality and is full of character and style with various choices in style, size and other options to suit your own individual tastes and requirements.



CLASSIC

The Classic collection from Burlington is beautifully formed, either as a curvaceous round design or a grand square model. This collection also features the invisible overflow, and innovative waste technology.

PAGES 10-19



CLOAKROOM

A selection of cloakroom options have been crafted so you can match your chosen style throughout the home. You'll find Edwardian, Victorian and more Classic styled cloakroom basins to achieve a consistent and beautiful look throughout every washroom.

PAGES 36-39



EDWARDIAN

The Edwardian collection is the ultimate in traditional bathrooms with structured corners and angular designs, the feel is unapologetic and proud.

PAGES 20-23



CONTEMPORARY

As the name suggests, the Contemporary collection is styled on the elegance of past times but with a modern day twist. Simplistic, structured lines form the basis for this striking ceramic collection. Available as full pedestal, semi-pedestal or with a chrome washstand.

PAGES 28-35



VICTORIAN

A delicate and refined range, the simplicity of this ceramic basin is stunning. Available in a medium (560mm) or large (610mm) and a range of pedestal and tap hole options, the versatility of this style allows you to continue the style throughout your home and brings an air of luxury to every room.

PAGES 24-27



The Classic basin collection from Burlington is beautifully formed, either as a grand square or round design. This collection also features an innovative waste technology. Choose a Classic basin with invisible overflow allowing you to have seamless ceramic without a plug. All Classic basins are available as one, two or three tap holes on standard or regal pedestals or a range of washstands and furniture.



· LEFT · Classic basin one tap hole with chrome basin stand, Claremont one tap hole basin mixer with pop-up waste and traditional basin bottle trap · TOP · Bloomsbury radiator with angled radiator valves, Classic basin with classic pedestal and Anglesey three tap hole basin mixer with pop-up waste · RIGHT · Classic round basin with Classic round pedestal, Claremont basin 5" pillar taps and plug and chain basin waste



Classic basin two tap hole with aluminium washstand, Claremont basin 5" taps

Classic Basins

Basin Shapes	Basins			Pedestals		Chrome Washstands		Aluminium Washstands
				Standard	Round Regal	Standard	Regal	
	Width	Depth	Code	Code	Code	Code	Code	Code
Rectangular	650	580	B15 *	P6	P9R	T49A CHR	T49ACHR +T62	T38 ALU** T43 WHI** T48 BLA**
	500	580	B20 *			T52 CHR		
Round	650	580	B17 *	P6	P9R			

* Classic basins are available with one, two or three tap holes. To order the correct basin configuration simply replace '**' with 1TH, 2TH or 3TH.

** To order the correct wash stand colour specify 'T38 ALU' for aluminium, 'T43 BLA' for black, or 'T48 WHI' for white

Select your basin shape

Choose from a rectangular or round basin.

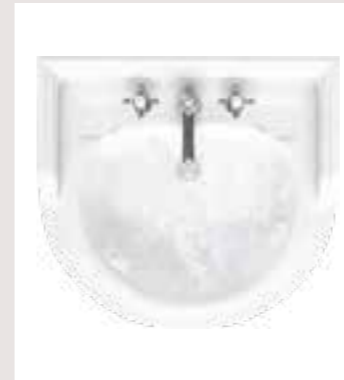

650mm Classic round basin



650mm Classic rectangular basin



500mm Classic rectangular basin

Select your pedestal style

Choose from a standard or regal pedestal, or add a touch of chrome or aluminium with a washstand.



650 Classic rectangular basin shown with regal round pedestal



650 Classic rectangular basin shown with standard pedestal



650 Classic rectangular basin shown with standard chrome washstand



650 Classic rectangular basin shown with aluminium washstand

invisible overflow



The benefit of invisible overflow means no requirement for a plug or external waste. Simply pull the lever up to drain water. Pair with the elegant and beautiful Arch basin mixer allowing you to mix hot and cold water.



Classic basin with invisible overflow, invisible overflow waste and two tap hole arch mixer with curved spout (200mm centres)

Classic Invisible Overflow Basins

Basin Shapes	Basins			Pedestals*		Chrome Washstands		Aluminium Washstands
				Standard	Round Regal	Standard	Regal	
	Width	Depth	Code	Code	Code	Code	Code	
Rectangular	650	580	B14*	P6	P9R	T49A CHR	T49ACHR +T62	T38 ALU** T43 WHI** T48 BLA**

Classic basins with invisible overflows are only available in two tap hole and must use basin waste W9

* Overall heights to the top of the front basin surface:

Classic basin with Standard pedestal: 860mm

Classic basin with Regal pedestal: 920mm

Classic basin with washstand: 880mm

Classic basin with Regal basin stand: 920mm

Classic basin with aluminium washstand: 890mm

** To order the correct wash stand colour specify 'T38 ALU' for aluminium, 'T48 BLA' for black, or 'T43 WHI' for white.

english garden



The English Garden range sees the Classic style basins brought to life with delicate floral flowers. The new round pedestal is softened with finite moulded detail. Select the English Garden collection to brighten your traditional bathroom.

· LEFT · English Garden close-coupled WC with cistern with soft-close seat in white and ceramic trap. English Garden round basin and English Garden round pedestal with Claremont one tap hole basin mixer with click-clack waste
· TOP · English Garden basin and English Garden pedestal with Claremont one tap hole basin mixer with central indice and click-clack waste



English Garden basin and English Garden pedestal with Claremont one tap hole basin mixer with central indice and click-clack waste

English Garden Classic Basins

Basin Shapes	Basins			Pedestals*		Chrome Washstands		Aluminium Washstands
				Standard	Round Regal	Standard	Regal	
	Width	Depth	Code	Code	Code	Code	Code	
Rectangular	650	580	B15D*		P9RD	T49A CHR	T49ACHR +T62	T38 ALU** T43 WHI** T48 BLA**
Round	650	580	B17D*					
Corner Wall Mounted basin	590	450	B10D***					

* Classic basins are available with one, two or three tap holes. To order the correct basin configuration simply replace '**' with 1TH, 2TH or 3TH.

** To order the correct wash stand colour specify 'T38 ALU' for aluminium, 'T43 BLA' for black, or 'T48 WHI' for white.

***B10D is compatible with T8 CHR towel rail

Select your basin shape

Choose from a rectangular or round basin.

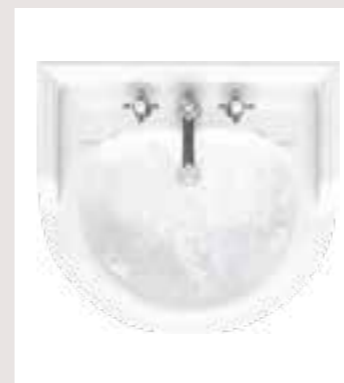

650mm Classic round basin



650mm Classic rectangular basin



500mm Classic rectangular basin

Select your pedestal style

Choose from a standard or regal pedestal, or add a touch of chrome or aluminium with a washstand.



650 Classic rectangular basin shown with regal round pedestal



650 Classic rectangular basin shown with standard pedestal



650 Classic rectangular basin shown with standard chrome washstand



650 Classic rectangular basin shown with aluminium washstand

edwardian



The Edwardian collection is the ultimate in traditional bathrooms with structured upstands and angular designs. Edwardian rectangular basins come in a range of sizes including 560mm, 610mm, 800mm and 1200mm, suitable for all pedestal and washstands and available in one, two or three tap hole options. The 560mm is also available as a round basin option with one or two tap holes, also suitable for pedestal and washstands.



· LEFT · Edwardian 1200mm basin with washstand shown with Claremont three tap hole basin mixer with pop-up waste · TOP · Edwardian 800mm basin with washstand, Claremont three tap hole basin mixer with pop-up waste, flat bottomed basin bottle trap and curved mirror · RIGHT · Edwardian round 56mm basin with pedestal, Claremont 5" basin pillar taps and plug and chain waste





Edwardian 800mm basin with Washstand and Claremont three tap hole basin with pop up waste

Select your basin shape

Choose from a rectangular or round basin.



560/610/800/1200mm Edwardian rectangular basin



560mm Edwardian round basin

Edwardian Basins

Basin Shapes	Basins			Pedestals			Chrome Washstands		Towel Rails
				Standard	Regal	Semi	Standard	Regal	
	Width	Depth	Code	Code	Code	Code	Code	Code	Code
Rectangular	560	470	B4 *	P1	P9	P8	T22A CHR	T22A CHR +T62	T1 CHR
	610	510	B5 *	P1	P9	P8	T23A CHR	T23A CHR +T62	T3 CHR
	800	510	B18 *	P6	P9R		T50 CHR	T50 CHR +T62	
	1200	510	B19 *	P6	P9R		T51 CHR	T51 CHR +T62	
Round	560	470	B6 *	P1	P9	P8	T24A CHR	T24A CHR +T62	T4 CHR

Edwardian Rectangular basins are available with one, two or three tap holes. To order the correct basin configuration simply replace '' with 1TH, 2TH or 3TH. 3 tap hole basins and the 1200mm basin cannot be used with the semi pedestal.

Select your pedestal style

Choose from a standard, regal or semi pedestal, or add a touch of chrome with a washstand or towel rail.



610mm Edwardian rectangular basin shown with standard pedestal



610mm Edwardian rectangular basin shown with chrome washstand



610mm Edwardian rectangular basin shown with semi pedestal and towel rail



A delicate and refined range, the simplicity of the Victorian range is stunning. Available in a large (610mm) and medium (560mm) with a range of pedestals, and in one, two or three tap hole options.



· LEFT · Victorian 610mm two tap hole basin and standard pedestal · TOP · Victorian 610mm basin with semi pedestal & towel rail, Claremont 5" pillar taps, plug and chain waste, tumbler and holder · RIGHT · Victorian 560mm basin with chrome basin stand and Claremont one tap hole basin mixer with high central indice, click clack waste and tumbler and holder



Victorian 560mm basin with regal pedestal Claremont three tap hole basin mixer with pop-up waste, rectangular mirror, round light with Chiffon silver shade each, soap dish and towel ring

Victorian Basins

Basins			Pedestals			Chrome Washstands		Towel Rails
			Standard	Regal	Semi	Standard	Regal	
Width	Depth	Code	Code	Code	Code	Code	Code	
560	470	B2 *	P1	P9	P8**	T22A CHR	T22A CHR +T62	T1 CHR
610	510	B3 *	P1	P9	P8**	T23A CHR	T23A CHR +T62	T3 CHR

* Victorian basins are available with one, two or three tap holes. To order the correct basin configuration simply replace '**' with 1TH, 2TH or 3TH.
 ** 3TH basins cannot be used with semi pedestals

Select your basin shape

Select the Victorian basin in either of the two sizes available.



560/610mm Victorian basin

Select your pedestal style

Choose from a standard, regal or semi pedestal, or add a touch of chrome with a washstand or towel rail.



610mm Victorian basin shown with standard pedestal



610mm Victorian basin shown with chrome washstand



610mm Victorian basin shown with semi pedestal and towel rail

contemporary



The Contemporary collection is styled on the elegance of past times but with a modern day twist. Simplistic, structured lines form the basis of this striking ceramic collection. Available as full pedestal, semi pedestal or with a chrome washstand, in one, two or three tap hole options.

ALSO AVAILABLE

Semi-recessed basin 580mm



Countertop basin 540mm



· LEFT · Rectangular mirror, Contemporary basin and semi pedestal with Claremont one tap hole basin mixer with high central indice and pop-up waste · TOP · Contemporary basin with semi pedestal, with Claremont one tap hole basin mixer with high central indice click clack waste, rectangular mirror · RIGHT · Semi Recessed basin 580mm with one tap hole and countertop basin 540mm with one tap hole



Contemporary basin and semi pedestal with Stafford mono basin mixer and pop-up waste

Contemporary Basin

Basins			Pedestals			Chrome Washstands		Towel Rails
Width	Depth	Code	Standard	Regal	Semi	Standard	Regal	Code
580	470	B1 *	P1	P9	P8	T22A CHR	T22A CHR +T62	T2 CHR

* Contemporary basins are available with one, two or three tap holes. To order the correct basin configuration simply replace "*" with 1TH, 2TH or 3TH.

Select your basin shape

Select our 580mm Contemporary basin below.



580mm Contemporary basin

Select your pedestal style

Choose from a standard, regal or semi pedestal, or add a touch of chrome with a washstand or towel rail.



580mm Contemporary basin shown with standard pedestal



580mm Contemporary basin shown with chrome washstand



580mm Contemporary basin shown with semi pedestal and towel rail

stone



Burlington stone covers both velvety soft natural stone basins and the divine marble and granite ranges. Pair exquisite pebble grey marble basin tops to either chrome or aluminium washstands. Marble and granite are natural materials, difference in colour, shading and veining are natural characteristics and this is part of their charm.

· LEFT · Carrara® marble top and basin with chrome washstand with Claremont three tap hole basin mixer with pop-up waste · RIGHT · Medium natural stone basin with stainless steel basin stand Claremont one tap hole basin mixer with click clack waste, and basin bottle trap





Carrara® marble top and basin with chrome washstand with Claremont three tap hole basin mixer with pop-up waste and basin bottle trap

Select your basin shape

Choose from our Marble or Natural Stone basins.



650mm Georgian Marble basin



550/650/750mm Natural Stone roll top basin

Natural Stone Basins

Natural Stone Roll Top Basins*				Stainless Steel Basin Stands
Model	Width	Depth	Code	Code
Small	550	470	B7E	B7ES
Medium	650	470	B8E	B8ES
Large	750	470	B9E	B9ES

Select your washstand

Match the stone basin with the corresponding basin stands and washstands below.



550/650/750mm Natural Stone basin shown with stainless steel basin stands



650mm Georgian Marble basin shown with standard chrome basin



650mm Georgian Marble basin shown with aluminium washstand

Georgian Marble Washstand

Basins			Chrome Washstands		Aluminium Washstands	Aluminium Washstands with Shelf
			Standard	Regal		
Width	Depth	Code	Code	Code	Code	Code
650	580	G1 *	T49A CHR	T49A CHR +T62	T38 ALU** T43 WHI** T48 BLA**	T38 ALU** + G11 T43 WHI** + G11 T48 BLA** + G11

* Natural Stone and Marble basins are available with no tap hole, 1 tap hole, 2 tap hole or 3 tap hole (drilled on site)
 **To order the correct wash stand colour specify 'T38 ALU' for aluminium, 'T48 BLA' for black, or 'T43 WHI' for white.
 Marble basins can be installed with rear & side upstands, rear upstand only or no upstand

cloakroom



*S*election of cloakroom options have been crafted so you can match your chosen style throughout the home. The cloakroom basins are available as wall-mounted, with or without a towel rail or alternatively a chrome washstand, except the Curved basin.



- LEFT · Corner cloakroom basin with Chelsea straight basin tap and click clack waste.
- TOP · Curved cloakroom basin with Claremont 3" basin taps, basin plug and chain and traditional basin bottle trap
- RIGHT · Edwardian cloakroom basin with standard chrome stand with Claremont 3" basin taps, basin plug and chain and traditional basin bottle trap.



Edwardian cloakroom basin with Claremont 3" basin taps, basin plug and chain and traditional basin bottle trap.

Cloakroom Basins

Basin Shape	Basins			Chrome Washstands		Towel Rails
				Standard	Regal	
	Width	Depth	Code	Code	Code	Code
Edwardian Rectangular	510	320	B8*	T21A CHR	T21A CHR +T62	T8 CHR
Curved	510	260	P13*			
Corner	600	450	B10			T8 CHR

* Edwardian & Curved Cloakroom basins are available with one tap hole on the right. To order this simply add 'R' to the product code.

Select your pedestal style

Select from the Edwardian, Curved or Corner basin with the four pedestals available.



510 Edwardian basin with towel rail or chrome washstand



510 Curved basin



600 Corner basin with towel rail

WC's



Regal

Standard



At Burlington we've created a range that's taller than average sanitaryware. Regal WC pans are 60mm higher than the standard option. At 480mm high the taller WC pan ensures the knee angle remains at approximately 90 degrees whilst in use, which is the correct seating position. At 480mm high the Regal WC's enable this. The taller WC provides a more comfortable use for taller people and the elderly whilst ensuring your WC is functional as well as beautiful too.



All Burlington WC fittings are factory set at 3L and 6L flush. They can be adjusted on site to flush at 2½L and 4½L.



All Burlington close coupled WC's are supplied with dual flush WRAS fittings.

CLOSE COUPLED & LOW LEVEL WCS

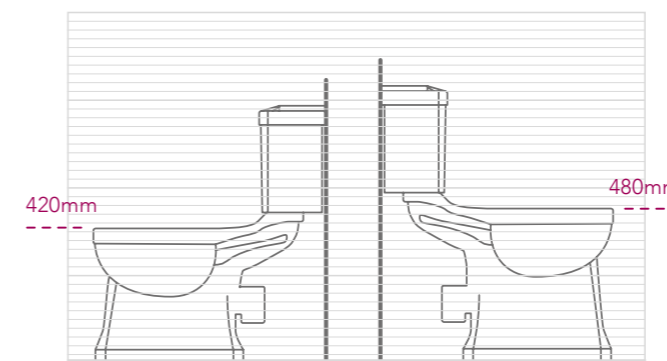

Standard close coupled WC

Regal close coupled WC

BACK TO WALL WCS

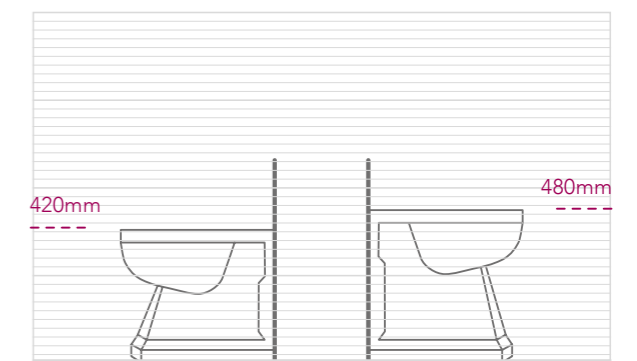

Standard back to wall WC

Regal back to wall WC

WC's

Burlington WC's come in a range of options, from the more contemporary wall-hung or back-to-wall options, to traditional close-coupled or the impressive low, medium or high-level WC's. All options feature water saving technology, only flushing 6L for a full flush or 3L for a half. These factory settings can be adjusted to 4 ½ L for a full flush or 2 ½L for a half flush. Pair your WC with a real wood seat to accentuate the classic styling. Unlike many other traditional brands, Burlington offer soft-close options on white, oak and mahogany seats, as well as sand and dark olive to pair with your furniture. For a premium look, select the throne seat with intricate and ornate brackets, which provide a focal point in your stunning traditional bathroom.



Wall hung Back to wall Close coupled Low level Medium level High level

nanoGLAZE
ceramic that stays cleaner

A CLEANER TOILET, BY DESIGN AND WITH NANO GLAZE

We believe that the toilet bowl should still remain as clean as possible even with reduced flushing water and therefore engineer our toilet bowls to maintain the correct water area as previous British Standards and by coating the toilet bowl with NANO Glaze to make them exceptionally easy to keep clean.



chrome cisterns



Chrome Cisterns

The T71 CHR chrome cistern is compatible with low and medium level WC's. The T70 CHR cistern is compatible with high level WC's.



Standard low level WC
with 440 chrome cistern
W 440 D 710 H 1340-1430 Pan Height 420

PAN P2
CISTERN T71 CHR
FLUSH PIPE T31 CHR



Standard medium level WC
with 440 chrome lever cistern
W 440 D 710 H 1340-1430 Pan Height 420

PAN P5
CISTERN T71 CHR
FLUSH PIPE T33 CHR



Standard high level WC
with chrome lever cistern
W 440 D 670 H 2300-2380 Pan Height 420

PAN P2
CISTERN T70 CHR
FLUSH PIPE T30 CHR

rimless



Rimless WC

The revolutionary rimless WC from Burlington.

HYGIENIC

- Easy to clean
- The interior of the bowl is a complete flush
- Dirt is removed easy and cannot hide under the rim
- Splash free
- Consistent flow of water in the toilet

DESIGN

- Attractive and timeless
- The only one of its kind in the traditional market
- Fits perfectly in to a traditional bathroom
- Same shape as the close couple pan within Burlington

ECONOMICAL

- Water saving
- Strong water flow for maximum flushing effect



HYGIENIC



EASY TO CLEAN



POWERFUL FLUSH



ECONOMIC



close coupled



Close Coupled

STANDARD



Standard CC WC with 520 lever cistern
W 520 D 730 H 780 Pan Height 420

PAN P5
CISTERN C1



Standard CC WC with 520 front push
button cistern
W 520 D 730 H 780 Pan Height 420

PAN P5
CISTERN C2



Standard CC WC with 440 lever cistern
W 440 D 730 H 780 Pan Height 420

PAN P5
CISTERN C3



Standard CC WC with 440 front push
button cistern
W 440 D 730 H 780 Pan Height 420

PAN P5
CISTERN C4



Standard CC WC with 520 rear entry
lever cistern
W 520 D 730 H 780 Pan Height 420

PAN P5
CISTERN C30



Standard English Garden CC WC with 520
English Garden lever cistern
W 520 D 730 H 780 Pan Height 420

PAN P5D
CISTERN C1D

Close Coupled

REGAL



Regal CC WC with 520 lever cistern
W 520 D 730 H 780 Pan Height 480

PAN P12
CISTERN C1



Regal CC WC with 520 front push
button cistern
W 520 D 730 H 780 Pan Height 480

PAN P12
CISTERN C2



Regal CC WC with 440 lever cistern
W 440 D 730 H 780 Pan Height 480

PAN P12
CISTERN C3



Regal CC WC with 440 front push
button cistern
W 440 D 730 H 780 Pan Height 480

PAN P12
CISTERN C4



Regal CC WC with 520 rear entry
lever cistern
W 520 D 730 H 780 Pan Height 480

PAN P12
CISTERN C30

Close Coupled

RIMLESS



Rimless CC WC with 520 lever cistern
W 520 D 730 H 780 Pan Height 420

PAN P20
CISTERN C1



Rimless CC WC with 520 front push
button cistern
W 520 D 730 H 780 Pan Height 420

PAN P20
CISTERN C2



Regal CC WC with 440 lever cistern
W 440 D 730 H 780 Pan Height 420

PAN P20
CISTERN C3



Rimless CC WC with 440 front push
button cistern
W 440 D 730 H 780 Pan Height 420

PAN P20
CISTERN C4



Rimless CC WC with 520 rear entry
lever cistern
W 520 D 730 H 780 Pan Height 420

PAN P20
CISTERN C30

Close Coupled

S TRAP



S trap CC WC with 520 lever cistern
W 520 D 730 H 780 Pan Height 420

PAN P18
CISTERN C1
TOTAL



S trap CC WC with 520 front push
button cistern
W 520 D 730 H 780 Pan Height 420

PAN P18
CISTERN C2
TOTAL



S trap CC WC with 440 lever cistern
W 440 D 730 H 780 Pan Height 420

PAN P18
CISTERN C3
TOTAL



S trap CC WC with 440 front push
button cistern
W 440 D 730 H 780 Pan Height 420

PAN P18
CISTERN C4
TOTAL



S trap CC WC with 520 rear entry
lever cistern
W 520 D 730 H 780 Pan Height 420

PAN P18
CISTERN C30
TOTAL

low level



Low Level

STANDARD



Standard low level WC
with 520 lever cistern
W 520 D 740 H 960-1140 Pan Height 420

PAN P2
CISTERN C1
FLUSH PIPE T31 CHR



Standard low level WC
with 520 front push button cistern
W 520 D 740 H 960-1140 Pan Height 420

PAN P2
CISTERN C2
FLUSH PIPE T31 CHR



Standard low level WC
with 440 lever cistern
W 440 D 740 H 960-1140 Pan Height 420

PAN P2
CISTERN C3
FLUSH PIPE T31 CHR



Standard low level WC
with 440 front push button cistern
W 440 D 740 H 960-1140 Pan Height 420

PAN P2
CISTERN C4
FLUSH PIPE T31 CHR



Standard low level WC
with 520 rear entry lever cistern
W 520 D 740 H 960-1140 Pan Height 420

PAN P2
CISTERN C30
FLUSH PIPE T31 CHR



Standard English Garden low level WC
with 520 English Garden lever cistern
W 520 D 740 H 960-1140 Pan Height 420

PAN P2D
CISTERN C1D
FLUSH PIPE T31 CHR

Low Level

REGAL



Regal low level WC with 520 lever cistern
W 520 D 740 H 960-1140 Pan Height 480

PAN P16
CISTERN C1
FLUSH PIPE T31 CHR



Regal low level WC
with 520 front push button cistern
W 520 D 740 H 960-1140 Pan Height 480

PAN P16
CISTERN C2
FLUSH PIPE T31 CHR



Regal low level WC with 440 lever cistern
W 440 D 740 H 960-1140 Pan Height 480

PAN P16
CISTERN C3
FLUSH PIPE T31 CHR



Regal low level WC
with 440 front push button cistern
W 440 D 740 H 960-1140 Pan Height 480

PAN P16
CISTERN C4
FLUSH PIPE T31 CHR



Regal low level WC
with 520 rear entry lever cistern
W 520 D 740 H 960-1140 Pan Height 480

PAN P16
CISTERN C30
FLUSH PIPE T31 CHR

Low Level

S TRAP



S trap low level WC with 520 lever cistern
W 520 D 740 H 960-1140 Pan Height 420

PAN P19
CISTERN C1
FLUSH PIPE T31 CHR



S trap low level WC with 520 front push
button cistern
W 520 D 740 H 960-1140 Pan Height 420

PAN P19
CISTERN C2
FLUSH PIPE T31 CHR



S trap low level WC with 440 lever cistern
W 440 D 740 H 960-1140 Pan Height 420

PAN P19
CISTERN C3
FLUSH PIPE T31 CHR



S trap low level WC with 440 front push
button cistern
W 440 D 740 H 960-1140 Pan Height 420

PAN P19
CISTERN C4
FLUSH PIPE T31 CHR



S trap low level WC with 520 rear entry
lever cistern
W 520 D 740 H 960-1140 Pan Height 420

PAN P19
CISTERN C30
FLUSH PIPE T31 CHR



Medium Level

STANDARD



Standard medium level WC
with 520 lever cistern
W 520 D 710 H 1340-1430 Pan Height 420

PAN P5
CISTERN C1
FLUSH PIPE T33 CHR



Standard medium level WC
with 520 front push button cistern
W 520 D 710 H 1340-1430 Pan Height 420

PAN P5
CISTERN C2
FLUSH PIPE T33 CHR



Standard medium level WC
with 440 lever cistern
W 440 D 710 H 1340-1430 Pan Height 420

PAN P5
CISTERN C3
FLUSH PIPE T33 CHR



Standard medium level WC
with 440 front push button cistern
W 440 D 710 H 1340-1430 Pan Height 420

PAN P5
CISTERN C4
FLUSH PIPE T33 CHR



Standard medium level WC
with 520 rear entry lever cistern
W 520 D 710 H 1340-1430 Pan Height 420

PAN P5
CISTERN C30
FLUSH PIPE T33 CHR



Standard English Garden medium level
WC with 520 English Garden lever cistern
W 520 D 710 H 1340-1430 Pan Height 420

PAN P5D
CISTERN C1D
FLUSH PIPE T33 CHR

Medium Level

REGAL



Regal medium level WC
with 520 lever cistern
W 520 D 710 H 1340-1430 Pan Height 480

PAN P12
CISTERN C1
FLUSH PIPE T33 CHR



Regal medium level WC
with 520 front push button cistern
W 520 D 710 H 1340-1430 Pan Height 480

PAN P12
CISTERN C2
FLUSH PIPE T33 CHR



Regal medium level WC
with 440 lever cistern
W 440 D 710 H 1340-1430 Pan Height 480

PAN P12
CISTERN C3
FLUSH PIPE T33 CHR



Regal medium level WC
with 440 front push button cistern
W 440 D 710 H 1340-1430 Pan Height 480

PAN P12
CISTERN C4
FLUSH PIPE T33 CHR



Regal medium level WC
with 520 rear entry lever cistern
W 520 D 710 H 1340-1430 Pan Height 480

PAN P12
CISTERN C30
FLUSH PIPE T33 CHR

Medium Level

RIMLESS



Rimless medium level WC with 520
lever cistern
W 520 D 710 H 1340-1430 Pan Height 420

PAN P20
CISTERN C1
FLUSH PIPE T33 CHR



Rimless medium level WC with 520 front
push button cistern
W 520 D 710 H 1340-1430 Pan Height 420

PAN P20
CISTERN C2
FLUSH PIPE T33 CHR



Rimless medium level WC with 440
lever cistern
W 440 D 710 H 1340-1430 Pan Height 420

PAN P20
CISTERN C3
FLUSH PIPE T33 CHR



Rimless medium level WC with 440 front
push button cistern
W 440 D 710 H 1340-1430 Pan Height 420

PAN P20
CISTERN C4
FLUSH PIPE T33 CHR



Rimless medium level WC with 520 rear
entry lever cistern
W 520 D 710 H 1340-1430 Pan Height 420

PAN P20
CISTERN C30
FLUSH PIPE T33 CHR

Medium Level

S TRAP



S trap medium level WC with 520 lever cistern
W 520 D 710 H 1340-1430 Pan Height 420

PAN P18
CISTERN C1
FLUSH PIPE T33 CHR



S trap medium level WC with 520 front push button cistern
W 520 D 710 H 1340-1430 Pan Height 420

PAN P18
CISTERN C2
FLUSH PIPE T33 CHR



S trap medium level WC with 440 lever cistern
W 440 D 710 H 1340-1430 Pan Height 420

PAN P18
CISTERN C3
FLUSH PIPE T33 CHR



S trap medium level WC with 440 front push button cistern
W 440 D 710 H 1340-1430 Pan Height 420

PAN P18
CISTERN C4
FLUSH PIPE T33 CHR



S trap medium level WC with 520 rear entry lever cistern
W 520 D 710 H 1340-1430 Pan Height 420

PAN P18
CISTERN C30
FLUSH PIPE T33 CHR

high level



DESIGN A BATHROOM TO SUIT YOUR SPECIFIC NEEDS

The angled high-level WC is a great option for those wanting to achieve the wow factor achieved with this type of WC, but needing to work around windows or within awkwardly shaped bathrooms. All high-level WC's are also supplied with a rigid pull rod to enable water saving; pull down for a full flush of 6 litres, or push up for a half flush of 3 litres. This can also be adjusted to 4.5 litres and 2.5 litres if required. Also available is a single flush chain and ceramic pull.



High Level

STANDARD



Standard high level WC
with dual flush ceramic cistern
W 520 D 670 H 2300-2380 Pan Height 420

PAN P2
CISTERN C5
FLUSH PIPE T30 CHR



Standard high level WC
with single flush ceramic cistern
W 520 D 670 H 2300-2380 Pan Height 420

PAN P2
CISTERN C28S
FLUSH PIPE T30 CHR



Standard high level WC
with dual flush aluminium cistern
W 430 D 670 H 2300-2380 Pan Height 420

PAN P2
CISTERN T58 ALU
FLUSH PIPE T30 CHR



Standard high level WC
with dual flush white aluminium cistern
W 430 D 670 H 2300-2380 Pan Height 420

PAN P2
CISTERN T59 WHI
FLUSH PIPE T30 CHR



Standard high level WC
with dual flush black aluminium cistern
W 430 D 670 H 2300-2380 Pan Height 420

PAN P2
CISTERN T60 BLA
FLUSH PIPE T30 CHR



Standard English Garden high level WC with
dual flush English Garden ceramic cistern
W 520 D 670 H 2300-2380 Pan Height 420

PAN P2D
CISTERN C5D
FLUSH PIPE T30 CHR

High Level

REGAL



Regal high level WC
with dual flush ceramic cistern
W 520 D 670 H 2300-2380 Pan Height 480

PAN P16
CISTERN C5
FLUSH PIPE T30 CHR



Regal high level WC
with single flush ceramic cistern
W 520 D 670 H 2300-2380 Pan Height 480

PAN P16
CISTERN C28S
FLUSH PIPE T30 CHR



Regal high level WC
with dual flush aluminium cistern
W 430 D 670 H 2300-2380 Pan Height 480

PAN P16
CISTERN T58 ALU
FLUSH PIPE T30 CHR



Regal high level WC
with dual flush white aluminium cistern
W 430 D 670 H 2300-2380 Pan Height 480

PAN P16
CISTERN T59 WHI
FLUSH PIPE T30 CHR



Regal high level WC
with dual flush black aluminium cistern
W 430 D 670 H 2300-2380 Pan Height 480

PAN P16
CISTERN T60 BLA
FLUSH PIPE T30 CHR

High Level

S TRAP



S trap high level WC
with dual flush ceramic cistern
W 520 D 670 H 2300-2380 Pan Height 420

PAN P19
CISTERN C5
FLUSH PIPE T30 CHR



S trap high level WC
with single flush ceramic cistern
W 520 D 670 H 2300-2380 Pan Height 420

PAN P19
CISTERN C28S
FLUSH PIPE T30 CHR



S trap high level WC
with dual flush aluminium cistern
W 430 D 670 H 2300-2380 Pan Height 420

PAN P19
CISTERN T58 ALU
FLUSH PIPE T30 CHR



S trap high level WC
with dual flush white aluminium cistern
W 430 D 670 H 2300-2380 Pan Height 420

PAN P19
CISTERN T59 WHI
FLUSH PIPE T30 CHR



S trap high level WC
with dual flush black aluminium cistern
W 430 D 670 H 2300-2380 Pan Height 420

PAN P19
CISTERN T60 BLA
FLUSH PIPE T30 CHR

black cistern levers



For black lever options see
pages 66 - 71. Available in
close coupled, low, medium
and high level WC's.

Available late spring 2018

Close Coupled

CLOSE COUPLED STANDARD



Standard CC WC with 520 lever cistern
W 520 D 730 H 780
Pan Height 420

PAN P5
CISTERN C1 BLA



Standard CC WC with 440 lever cistern
W 440 D 730 H 780
Pan Height 420

PAN P5
CISTERN C3 BLA



Standard CC WC with 520 rear entry lever cistern
W 520 D 730 H 780
Pan Height 420

PAN P5
CISTERN C30 BLA

CLOSE COUPLED REGAL



Regal CC WC with 520 lever cistern
W 520 D 730 H 780
Pan Height 480

PAN P12
CISTERN C1 BLA



Regal CC WC with 440 lever cistern
W 440 D 730 H 780
Pan Height 480

PAN P12
CISTERN C3 BLA



Regal CC WC with 520 rear entry lever cistern
W 520 D 730 H 780
Pan Height 480

PAN P12
CISTERN C30 BLA

Close Coupled

CLOSE COUPLED RIMLESS



Rimless CC WC with 520 lever cistern
W 520 D 730 H 780
Pan Height 420

PAN P20
CISTERN C1 BLA



Regal CC WC with 440 lever cistern
W 440 D 730 H 780
Pan Height 420

PAN P20
CISTERN C3 BLA



Rimless CC WC with 520 rear entry lever cistern
W 520 D 730 H 780
Pan Height 420

PAN P20
CISTERN C30 BLA

CLOSE COUPLED S TRAP



S trap CC WC with 520 lever cistern
W 520 D 730 H 780
Pan Height 420

PAN P18
CISTERN C1 BLA



S trap CC WC with 440 lever cistern
W 440 D 730 H 780
Pan Height 420

PAN P18
CISTERN C3 BLA



S trap CC WC with 520 rear entry lever cistern
W 520 D 730 H 780
Pan Height 420

PAN P18
CISTERN C30 BLA

Low Level

LOW LEVEL STANDARD



Standard low level WC with 520 lever cistern
W 520 D 740 H 960-1140
Pan Height 420

PAN P2
CISTERN C1 BLA
FLUSH PIPE T31 CHR



Standard low level WC with 440 lever cistern
W 440 D 740 H 960-1140
Pan Height 420

PAN P2
CISTERN C3 BLA
FLUSH PIPE T31 CHR



Standard low level WC with 520 rear entry lever cistern
W 520 D 740 H 960-1140
Pan Height 420

PAN P2
CISTERN C30 BLA
FLUSH PIPE T31 CHR



Standard English Garden low level WC with 520 English Garden lever cistern
W 520 D 740 H 960-1140
Pan Height 420

PAN P2D
CISTERN C1D BLA
FLUSH PIPE T31 CHR

Low / Medium Level

LOW LEVEL S TRAP



S trap low level WC with 520 lever cistern
W 520 D 740 H 960-1140
Pan Height 420

PAN P19
CISTERN C1 BLA
FLUSH PIPE T31 CHR



S trap low level WC with 440 lever cistern
W 440 D 740 H 960-1140
Pan Height 420

PAN P19
CISTERN C3 BLA
FLUSH PIPE T31 CHR



S trap low level WC with 520 rear entry lever cistern
W 520 D 740 H 960-1140
Pan Height 420

PAN P19
CISTERN C30 BLA
FLUSH PIPE T31 CHR

LOW LEVEL REGAL



Regal low level WC with 520 lever cistern
W 520 D 740 H 960-1140
Pan Height 480

PAN P16
CISTERN C1 BLA
FLUSH PIPE T31 CHR



Regal low level WC with 440 lever cistern
W 440 D 740 H 960-1140
Pan Height 480

PAN P16
CISTERN C3 BLA
FLUSH PIPE T31 CHR



Regal low level WC with 520 rear entry lever cistern
W 520 D 740 H 960-1140
Pan Height 480

PAN P16
CISTERN C30 BLA
FLUSH PIPE T31 CHR

MEDIUM LEVEL STANDARD



Standard medium level WC with 520 lever cistern
W 520 D 710 H 1340-1430
Pan Height 420

PAN P5
CISTERN C1 BLA
FLUSH PIPE T33 CHR



Standard medium level WC with 440 lever cistern
W 440 D 710 H 1340-1430
Pan Height 420

PAN P5
CISTERN C3 BLA
FLUSH PIPE T33 CHR



Standard medium level WC with 520 rear entry lever cistern
W 520 D 710 H 1340-1430
Pan Height 420

PAN P5
CISTERN C30 BLA
FLUSH PIPE T33 CHR



Standard English Garden medium level WC with 520 English Garden lever cistern
W 520 D 710 H 1340-1430
Pan Height 420

PAN P5D
CISTERN C1D BLA
FLUSH PIPE T33 CHR

Medium Level

MEDIUM LEVEL REGAL



Regal medium level WC with 520 lever cistern
W 520 D 710 H 1340-1430
Pan Height 480

PAN P12
CISTERN C1 BLA
FLUSH PIPE T33 CHR



Regal medium level WC with 440 lever cistern
W 440 D 710 H 1340-1430
Pan Height 480

PAN P12
CISTERN C3 BLA
FLUSH PIPE T33 CHR



Regal medium level WC with 520 rear entry lever cistern
W 520 D 710 H 1340-1430
Pan Height 480

PAN P12
CISTERN C30 BLA
FLUSH PIPE T33 CHR

MEDIUM LEVEL RIMLESS



Rimless medium level WC with 520 lever cistern
W 520 D 710 H 1340-1430
Pan Height 420

PAN P20
CISTERN C1 BLA
FLUSH PIPE T33 CHR



Rimless medium level WC with 440 lever cistern
W 440 D 710 H 1340-1430
Pan Height 420

PAN P20
CISTERN C3 BLA
FLUSH PIPE T33 CHR



Rimless medium level WC with 520 rear entry lever cistern
W 520 D 710 H 1340-1430
Pan Height 420

PAN P20
CISTERN C30 BLA
FLUSH PIPE T33 CHR

Medium / High Level

MEDIUM LEVEL S TRAP



S trap medium level WC with 520 lever cistern
W 520 D 710 H 1340-1430
Pan Height 420

PAN P18
CISTERN C1 BLA
FLUSH PIPE T33 CHR



S trap medium level WC with 440 lever cistern
W 440 D 710 H 1340-1430
Pan Height 420

PAN P18
CISTERN C3 BLA
FLUSH PIPE T33 CHR



S trap medium level WC with 520 rear entry lever cistern
W 520 D 710 H 1340-1430
Pan Height 420

PAN P18
CISTERN C30 BLA
FLUSH PIPE T33 CHR

HIGH LEVEL STANDARD



Standard high level WC with single flush ceramic cistern
W 520 D 670 H 2300-2380
Pan Height 420

PAN P2
CISTERN C28S
FLUSH PIPE T30 CHR



Regal high level WC with single flush ceramic cistern
W 520 D 670 H 2300-2380
Pan Height 480

PAN P16
CISTERN C28S BLA
FLUSH PIPE T30 CHR



S trap high level WC with single flush ceramic cistern
W 520 D 670 H 2300-2380
Pan Height 420

PAN P19
CISTERN C28S BLA
FLUSH PIPE T30 CHR

HIGH LEVEL REGAL

HIGH LEVEL S TRAP

Back to Wall



Regal back to wall
W 370 D 480 H 480

P15



Back to wall
W 370 D 480 H 420

P14



Wall hung
W 400 D 570 H 360

P10

Bidets



Wall hung
W 370 D 500 H 360

P11



Floor standing
W 400 D 570 H 400

P4



English garden floor standing
W 400 D 570 H 400

P4D



Ceramic traps for converting
P trap to S trap

C26



Straight ceramic trap

C29

Pair the wall hung
WC with a concealed
cistern F6CC

Seats

S43, S44, S45, S46, S47, S48 AVAILABLE AS SOFT-CLOSE ONLY.

All seats are supplied
without handles. To
add seat handles use
code A51CHR.



Soft close sand seat
(excluding handles)

S43



Soft close sand seat
(excluding handles)

S43



Soft close dark olive seat
(excluding handles)

S44



Soft close matt white seat
(excluding handles)

S45



Soft close matt black seat
(excluding handles)

S48



Soft close walnut solid wood
seat (excluding handles)

S47



Standard oak seat
(excluding handles)

S11



Standard gloss mahogany seat
(excluding handles)

S12



Standard white carbamide seat
(not suitable for handles)

S13



Oak throne set (not suitable
for handles)

S14



Mahogany throne set (not
suitable for handles)

S15

Soft close (not suitable
for handles)

S18

Soft close (excluding handles)

S16

Soft close (excluding handles)

S17



Furniture

Introducing Burlington furniture, a range of beautifully traditional solutions to add classic style and sophisticated British elegance to your bathroom.

Choose from freestanding in either a square or curved design, wall hung or fully-fitted options to tailor make the most functional use of space to suit your individual needs. A new range of baths each with panels or surrounds in corresponding colours, transform your entire bathroom into a space of peace and tranquillity with a subtle, traditionally British feel.

Each piece is packed full of innovative detailing such as soft close doors and drawers, internal lighting and wide opening spaces for maximum storage capacity.

NEW GREY FURNITURE

Available late Spring 2018.



HDP • The plinths of the freestanding furniture are crafted from HDP Polymer - a waterproof base providing extra protection and giving peace of mind that wet floors will not lead to damage.



DIMENSIONS & TECHNICAL DRAWINGS • Dimensional drawings and technical details are shown at burlingtonbathrooms.com/furniture



TAP HOLES • Minerva® worktops are supplied with an integrated bowl with overflow, and no tap holes. Tap holes are drilled by the installer in the required position and configuration. A template is provided with the Minerva® tops indicating tap hole positions and sizes.



STAINING • Minerva®, unlike marble and granite, is not porous and will resist most household chemicals including alcohol and cosmetics, however, some chemicals and strong dyes can cause damage and discolouration. If spillage occurs, wipe off immediately and rinse the area thoroughly.



MINERVA® CARE KIT • To restore your Minerva® work top to its original best use the Care Kit to buff out all tiny scratches and scuffs. The kit contains all the sanding / buffing materials and liquids required.



ROUTINE CLEANING • Minerva® does not require any specialist cleaning regimes, most dirt and light residue will easily wipe off with a damp cloth and soapy water. The work surface should then be rinsed with clean water and wiped dry. Persistent marks can be removed by using a mild abrasive cleaner, but harsh scouring powders should be avoided.



MINOR SCRATCHING • Scratches to the work surface will be more evident on darker colours. Any minor scratches can be removed using a woven abrasive pad and other items in the care kit.

cloakroom



A unique and stylish corner unit from Burlington, for use with the 430mm Quattrocast basin and available as one tap hole only. Choose from in dark olive, matt white, sand or classic grey, team this with a Chelsea straight basin mixer for a truly classic look, perfect for any cloakroom or bathroom space.

· ALL · Burlington 430mm by 430mm Quattrocast corner basin 1TH, shown with 430mm corner unit in matt white and Chelsea straight basin mixer without waste. With nickel handles.





Freestanding matt white cloakroom vanity unit with single door and Edwardian basin

Freestanding Cloakroom Vanity Unit

Cloakroom Shape	Cloakroom Unit							
	Dimensions				Colour			
	Type	Width	Depth	Height	Matt White Code	Sand Code	Dark Olive Code	Classic Grey Code
Rectangular	1 Door	510	310	760	FC11W + B8	FC11S + B8	FC11O + B8	FC11G + B8
Square	1 Door	500	500	760	FC8W + B20	FC8S + B20	FC8O + B20	FC8G + B20
Corner	1 Door	445	445	785	FC7W + FC7BB	FC7S + FC7BB	FC7O + FC7BB	FC7G + FC7BB

Nickel handles sold as individual product

Select your cloakroom shape & colour

Choose from our cloakroom unit options.



Freestanding cloakroom vanity unit in matt white



Freestanding cloakroom vanity unit in sand



Freestanding cloakroom vanity unit in dark olive



Freestanding cloakroom vanity unit in classic grey



Freestanding 500mm square cloakroom unit in matt white



Freestanding 500mm square cloakroom unit in sand



Freestanding 500mm square cloakroom unit in dark olive



Freestanding 500mm square cloakroom unit in classic grey



Freestanding corner cloakroom vanity unit in matt white



Freestanding corner cloakroom vanity unit in sand



Freestanding corner cloakroom vanity unit in dark olive



Freestanding corner cloakroom vanity unit in classic grey



HDP



DIMENSIONS



TAP HOLES



STAINING



MINERVA®
CARE KIT



MINOR
SCRATCHING



ROUTINE
CLEANING

All measurements are represented in mm. For detailed dimensions see burlingtonbathrooms.com

650 freestanding



The 650 freestanding furniture with your choice of classic basin is the perfect solution for those needing to save space but still require storage solutions for their bathroom. With a width of just 650mm, this stylish piece combines beautiful ceramic or integrated basins atop units with either drawers or doors so you can tailor your bathroom to your preferred style.



· LEFT · Sand Freestanding 650 Vanity Unit with doors, 650mm Classic basin for integrated waste & overflow with two tapholes, Birkenhead Basin taps 5" , Basin Plug and Chain, 600mm Mirror without LED in Sand · TOP · Sand Freestanding 650 Vanity Unit with doors, 650mm Classic basin for integrated waste & overflow with two tapholes, Claremont two taphole Arch mixer, Classic basin invisible overflow & waste, 600mm Mirror without LED in Sand · RIGHT · Dark Olive Freestanding 650 Vanity Unit with doors, 670mm x 550mm Minerva Carrara White with integrated basin with one taphole, Claremont basin mixer with high central indice with click-clack waste, 600mm LED Mirror in Dark Olive.

650 Freestanding Unit

Cloakroom Shape	Vanity Unit								
	Dimensions					Colour			
	Type	Width	Depth	Height	+Splash	Matt White	Sand	Dark Olive	Classic Grey
Code						Code	Code	Code	
Freestanding 650 vanity unit with doors & Classic 650 basin for standard waste & overflow	2 Doors	670	580	930		FF8W + B15	FF8S + B15	FF8O + B15	FF8G + B15
Freestanding 650 vanity unit with doors & Classic 650 basin for integrated waste & overflow	2 Doors	670	580	930		FF8W + B14	FF8S + B14	FF8O + B14	FF8G + B14
Freestanding 650 vanity unit with doors & Minerva® Carrara white with vanity bowl	2 Doors	670	550	850	930	FF8W + BC66	FF8S + BC66	FF8O + BC66	FF8G + BC66
Freestanding 650 vanity unit with doors & Minerva® white with vanity bowl	2 Doors	670	550	850	930	FF8W + BW66	FF8S + BW66	FF8O + BW66	FF8G + BW66
Freestanding 650 vanity unit with doors & Minerva® black granite with vanity bowl	2 Doors	670	550	850	930	FF8W + BB66	FF8S + BB66	FF8O + BB66	FF8G + BB66
Freestanding 650 vanity unit with drawers & Classic 650 basin for standard waste & overflow	2 Drawer	670	580	930		FF9W + B15	FF9S + B15	FF9O + B15	FF9G + B15
Freestanding 650 vanity unit with drawers & Classic 650 basin for integrated waste & overflow	2 Drawer	670	580	930		FF9W + B14	FF9S + B14	FF9O + B14	FF9G + B14
Freestanding 650 vanity unit with drawers & Minerva® Carrara white with vanity bowl	2 Drawer	670	550	850	930	FF9W + BC66	FF9S + BC66	FF9O + BC66	FF9G + BC66
Freestanding 650 vanity unit with drawers & Minerva® white with vanity bowl	2 Drawer	670	550	850	930	FF9W + BW66	FF9S + BW66	FF9O + BW66	FF9G + BW66
Freestanding 650 vanity unit with drawers & Minerva® black granite with vanity bowl	2 Drawer	670	550	850	930	FF9W + BB66	FF9S + BB66	FF9O + BB66	FF9G + BB66

Nickel handles sold as individual product

■ With doors □ With drawers

Select your basin style

Choose from the five different styles to go with the unit.

Classic 650 basin for standard waste & overflow

Classic 650 basin for integrated waste & overflow

Minerva® Carrara white with vanity bowl

Minerva® white with vanity bowl

Minerva® black granite with vanity bowl

Select your unit colour

Choose from our four colours with either doors or drawers.

Freestanding cloakroom vanity unit in matt white

Freestanding cloakroom vanity unit in sand

Freestanding cloakroom vanity unit in dark olive

Freestanding cloakroom vanity unit in classic grey

- HDP
- DIMENSIONS
- TAP HOLES
- STAINING
- MINERVA® CARE KIT
- MINOR SCRATCHING
- ROUTINE CLEANING



Matt white Wall Hung 650 Vanity unit with a single drawer, 660mm x 550mm Minerva white with integrated basin with one tap hole, Claremont basin mixer with high central indice with click-clack waste.

650 Wall Hung Unit

Complete Unit	Vanity Unit								
	Dimensions					Colour			
	Type	Width	Depth	Height	+Splash	Matt White	Sand	Dark Olive	Classic Grey
						Code	Code	Code	Code
Wall hung 650 vanity unit with single drawer & Classic basin for standard waste & overflow	1 Drawer	660	580	580		FW1W + B15	FW1S + B15	FW1O + B15	FW1G + B15
Wall hung 650 vanity unit with single drawer & Classic basin for integrated waste & overflow	1 Drawer	660	580	580		FW1W + B14	FW1S + B14	FW1O + B14	FW1G + B14
Wall hung 650 vanity unit with single drawer & Minerva® Carrara white with vanity bowl	1 Drawer	670	550	510	590	FW1W + BC66	FW1S + BC66	FW1O + BC66	FW1G + BC66
Wall hung 650 vanity unit with single drawer & Minerva® white with vanity bowl	1 Drawer	670	550	510	590	FW1W + BW66	FW1S + BW66	FW1O + BW66	FW1G + BW66
Wall hung 650 vanity unit with single drawer & Minerva® black granite with vanity bowl	1 Drawer	670	550	510	590	FW1W + BB66	FW1S + BB66	FW1O + BB66	FW1G + BB66

Nickel handles sold as individual product

Select your basin style

Choose from the five different styles to go with the unit.



Classic 650 basin for standard waste & overflow



Classic 650 basin for integrated waste & overflow



Minerva® Carrara white with vanity bowl



Minerva® white with vanity bowl



Minerva® black granite with vanity bowl

Select your unit colour

Choose from our four colours; matt white, sand, dark olive or classic grey.



650 Wall Hung unit in matt white



650 Wall Hung unit in sand



650 Wall Hung unit in dark olive



650 Wall Hung unit in classic grey

NEW



HDP



DIMENSIONS



TAP HOLES



STAINING



MINERVA® CARE KIT



MINOR SCRATCHING



ROUTINE CLEANING

1300 freestanding



Why not select the double basin option for a traditionally British feel. Choose from three exclusive Minerva® worktop colours available in either pristine white, opulent black granite, or luxurious Carrara white, each with a generous sized double basin bowl of 380x310mm. Each of the Burlington furniture pieces are equipped with soft-close door hinges and drawer runners for that extra feeling of indulgence in your bathroom. Select either the four drawer or double doors option to match your storage requirements.

· LEFT · Sand 1300 Freestanding Vanity unit with drawers, 1300mm x 550mm Minerva black granite with two integrated basins with one taphole, Chelsea straight basin mixers with pop up (two required) each, 900mm sand mirror without LED. · TOP · Matt white 1300 Freestanding Vanity unit with doors, 1300mm x 550mm Minerva Carrara white with two integrated basins with one taphole, Kensington basin mixer with click clack waste (two required) each.



White 1300 freestanding vanity unit with doors, shown with Minerva® Carrara white double basin worktop and basin mono's

1300 Freestanding Unit

Complete Unit	Vanity Unit								
	Dimensions					Colour			
	Type	Width	Depth	Height	+Splash	Matt White	Sand	Dark Olive	Classic Grey
						Code	Code	Code	Code
Freestanding 1300 vanity unit with doors & Minerva® Carrara white with double vanity bowl	4 Doors	1300	550	850	930	FC9W + BC12	FC9S + BC12	FFC9O + BC12	FFC9G + BC12
Freestanding 1300 vanity unit with doors & Minerva® white with double vanity bowl	4 Doors	1300	550	850	930	FC9W + BW12	FC9S + BW12	FC9O + BW12	FC9G + BW12
Freestanding 1300 vanity unit with doors & Minerva® black granite with double vanity bowl	4 Doors	1300	550	850	930	FC9W + BB12	FC9S + BB12	FC9O + BB12	FC9G + BB12
Freestanding 1300 vanity unit with drawers & Minerva® Carrara white with double vanity bowl	4 Drawer	1300	550	850	930	FC10W + BC12	FC10S + BC12	FC10O + BC12	FC10G + BC12
Freestanding 1300 vanity unit with drawers & Minerva® white with double vanity bowl	4 Drawer	1300	550	850	930	FC10W + BW12	FC10S + BW12	FC10O + BW12	FC10G + BW12
Freestanding 1300 vanity unit with drawers & Minerva® black granite with double vanity bowl	4 Drawer	1300	550	850	930	FC10W + BB12	FC10S + BB12	FC10O + BB12	FC10G + BB12

Nickel handles sold as individual product

With doors
 With drawers

Select your basin style

Choose between our three different worktop designs.



Minerva® Carrara white with double vanity bowl



Minerva® white with double vanity bowl



Minerva® black granite with double vanity bowl

Select your unit colour

Choose from our four colours with either doors or drawers.



1300 Freestanding vanity unit in matt white with Minerva® white double bowl



1300 Freestanding vanity unit in sand with Minerva® white double bowl



1300 Freestanding vanity unit in dark olive with Minerva® white double bowl



1300 Freestanding vanity unit in classic grey with Minerva® white double bowl

NEW



HDP



DIMENSIONS



TAP HOLES



STAINING



MINERVA® CARE KIT



MINOR SCRATCHING



ROUTINE CLEANING

1340 curved unit



Our freestanding round design cabinets feature open wide doors for easy access to ample storage space. Perfect for hiding away everyday bathroom necessities and keeping worktops free from clutter. This striking piece is available either as a centrepiece or as left and right handed options for perfect placement against a wall or into a corner.

· LEFT · Dark Olive 1340 Curved Freestanding Vanity Unit with Doors and Drawers, 1340mm x 550mm Minerva Carrara White with integrated basin with three tapholes, Kensington Regent three taphole basin mixer with pop up waste, 500mm x 700mm Arched Mirror, Two Burlington Ornate lights with Vase clear glass shades each.





Matt white 1340 Curved Freestanding vanity unit with doors and drawers, 1340mm x 550mm Minerva Carrara white with integrated basin with three tapholes, Claremont Regent three taphole basin mixer with pop up waste.

1340 Curved Vanity Unit

Complete Unit	Vanity Unit								
	Dimensions					Colour			
	Type	Width	Depth	Height	+Splash	Matt White	Sand	Dark Olive	Classic Grey
						Code	Code	Code	Code
Freestanding 1340 curved vanity unit with doors & Minerva® Carrara white with vanity bowl	4 Doors	1340	550	850	930	FC1W + BC13	FC1S + BC13	FC1O + BC13	FC1G + BC13
Freestanding 1340 curved vanity unit with doors & Minerva® white with vanity bowl	4 Doors	1340	550	850	930	FC1W + BW13	FC1S + BW13	FC1O + BW13	FC1G + BW13
Freestanding 1340 curved vanity unit with doors & Minerva® black granite with vanity bowl	4 Doors	1340	550	850	930	FC1W + BB13	FC1S + BB13	FC1O + BB13	FC1G + BB13
Freestanding 1340 curved vanity unit with doors & drawers & Minerva® Carrara white with vanity bowl	2 Drawer 2 Door	1340	550	850	930	FC4W + BC13	FC4S + BC13	FC4O + BC13	FC4G + BC13
Freestanding 1340 curved vanity unit with doors & drawers & Minerva® white with vanity bowl	2 Drawer 2 Door	1340	550	850	930	FC4W + BW13	FC4S + BW13	FC4O + BW13	FC4G + BW13
Freestanding 1340 curved vanity unit with doors & drawers & Minerva® black granite with vanity bowl	2 Drawer 2 Door	1340	550	850	930	FC4W + BB13	FC4S + BB13	FC4O + BB13	FC4G + BB13

Nickel handles sold as individual product

With doors
 With drawers

Select your basin style

Choose between our three different worktop designs.



Minerva® Carrara white with vanity bowl



Minerva® white with vanity bowl



Minerva® black granite with vanity bowl

Select your unit colour

Choose from our four colours with either doors or drawers.



1340 Curved vanity unit in matt white with Minerva® white bowl



1340 Curved vanity unit in sand with Minerva® white bowl



1340 Curved vanity unit in dark olive with Minerva® white bowl

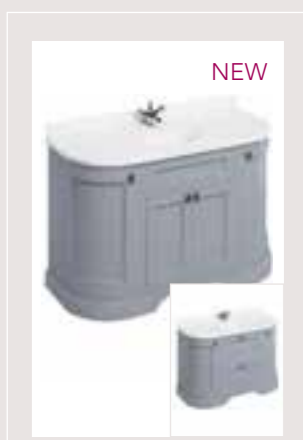

1340 Curved vanity unit in classic grey with Minerva® white bowl

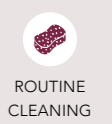
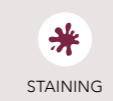
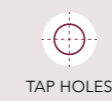



Sand Wall Hung 1340 Curved vanity unit, 1340mm x 550mm Minerva white with one integrated basin with one tap hole, Chelsea curved basin mixer with pop up waste.

1340 Curved Wall Unit

Complete Unit	Wall Unit								
	Dimensions					Colour			
	Type	Width	Depth	Height	+Splash	Matt White	Sand	Dark Olive	Classic Grey
						Code	Code	Code	Code
1340 Curved wall hung vanity unit & Minerva® white with vanity bowl	3 Doors	1340	550	510	590	FW4W + BW13	FW4S + BW13	FW4O + BW13	FW4G + BW13
1340 Curved wall hung vanity unit & Minerva® black granite with vanity bowl	3 Doors	1340	550	510	590	FW4W + BB13	FW4S + BB13	FW4O + BB13	FW4G + BB13
1340 Curved wall hung vanity unit & Minerva® Carrara white with vanity bowl	3 Doors	1340	550	510	590	FW4W + BC13	FW4S + BC13	FW4O + BC13	FW4G + BC13

Nickel handles sold as individual product

Select your basin style

Choose between our three different worktop designs.



Minerva® Carrara white with vanity bowl



Minerva® white with vanity bowl



Minerva® black granite with vanity bowl

Select your unit colour

Choose from our four colours; matt white, sand, dark olive or classic grey.



1340 Curved Wall unit in matt white with Minerva® white bowl



1340 Curved Wall unit in sand with Minerva® white bowl



1340 Curved Wall unit in dark olive with Minerva® white bowl



1340 Curved Wall unit in classic grey with Minerva® white bowl



HDP



DIMENSIONS



TAP HOLES



STAINING



MINERVA® CARE KIT



MINOR SCRATCHING



ROUTINE CLEANING

1000 curved unit



Our freestanding round design units feature open wide doors for easy access to ample storage space. Perfect for hiding away everyday bathroom necessities and keeping worktops free from clutter. This striking piece is available either as a centrepiece or as left and right handed options for perfect placement against a wall or into a corner.

· ALL · Matt White Freestanding 1000 Curved Corner Vanity Unit with right hand door, 1340mm x 550mm Minerva Carrara White with right handed integrated basin with three tapholes, Anglesey three tap hole mixer with pop up waste.

All measurements are represented in mm. For detailed dimensions see burlingtonbathrooms.com



1000 Curved Vanity Unit

Complete Unit	Vanity Unit								
	Dimensions					Colour			
	Type	Width	Depth	Height	+Splash	Matt White	Sand	Dark Olive	Classic Grey
						Code	Code	Code	Code
Freestanding 1000 curved left handed vanity unit with doors & Minerva® Carrara white with left handed vanity bowl	LH 3 Door	980	550	850	930	FC2W + BC98L	FC2S + BC98L	FC2O + BC98L	FC2G + BC98L
Freestanding 1000 curved left handed vanity unit with doors & Minerva® white with left handed vanity bowl	LH 3 Door	980	550	850	930	FC2W + BW98L	FC2S + BW98L	FC2O + BW98L	FC2G + BW98L
Freestanding 1000 curved left handed vanity unit with doors & Minerva® black granite with left handed vanity bowl	LH 3 Door	980	550	850	930	FC2W + BB98L	FC2S + BB98L	FC2O + BB98L	FC2G + BB98L
Freestanding 1000 curved right handed vanity unit with doors & Minerva® Carrara white with right handed vanity bowl	RH 3 Door	980	550	850	930	FC3W + BC98R	FC3S + BC98R	FC3O + BC98R	FC3G + BC98R
Freestanding 1000 curved right handed vanity unit with doors & Minerva® white with right handed vanity bowl	RH 3 Door	980	550	850	930	FC3W + BW98R	FC3S + BW98R	FC3O + BW98R	FC3G + BW98R
Freestanding 1000 curved right handed vanity unit with doors & Minerva® black granite with right handed vanity bowl	RH 3 Door	980	550	850	930	FC3W + BB98R	FC3S + BB98R	FC3O + BB98R	FC3G + BB98R

Nickel handles sold as individual product

Select your basin style

Choose between our three different worktop designs.



Minerva® Carrara white with vanity bowl



Minerva® white with vanity bowl



Minerva® black granite with vanity bowl

Select your unit colour

Choose from our four colours in either the left or right hand unit.



1000 Curved vanity left / right unit in matt white with Minerva® white bowl



1000 Curved vanity left / right unit in sand with Minerva® white bowl



1000 Curved vanity left / right unit in dark olive with Minerva® white bowl



1000 Curved vanity left / right unit in classic grey with Minerva® white bowl



HDP



DIMENSIONS



TAP HOLES



STAINING



MINERVA® CARE KIT



MINOR SCRATCHING



ROUTINE CLEANING



Dark Olive right handed Wall Hung 1000 Curved Corner Vanity Unit, 980mm x 550mm Minerva® Carrara White with right handed integrated basin with three tap holes, Anglesey three tap hole basin mixer with pop up waste.

1000 Curved Wall Unit

Complete Unit	Wall Unit								
	Dimensions					Colour			
	Type	Width	Depth	Height	+Splash	Matt White	Sand	Dark Olive	Classic Grey
						Code	Code	Code	Code
1000 Curved wall hung left handed vanity unit with drawer & Minerva® white with left hand vanity bowl	LH 2 Door	980	550	510	590	FW5W + BW98L	FW5S + BW98L	FW5O + BW98L	FW5G + BW98L
1000 Curved wall hung left handed vanity unit with drawer & Minerva® black granite with left hand vanity bowl	LH 2 Door	980	550	510	590	FW5W + BB98L	FW5WS + BB98L	FW5O + BB98L	FW5G + BB98L
1000 Curved wall hung left handed vanity unit with drawer & Minerva® Carrara white with left hand vanity bowl	LH 2 Door	980	550	510	590	FW5W + BC98L	FW5S + BC98L	FW5O + BC98L	FW5G + BC98L
1000 Curved wall hung right handed vanity unit with doors & Minerva® white with right handed vanity bowl	RH 2 Door	980	550	510	590	FW5W + BW98R	FW5S + BW98R	FW5O + BW98R	FW5G + BW98R
1000 Curved wall hung right handed vanity unit with doors & Minerva® black granite with right handed vanity bowl	RH 2 Door	980	550	510	590	FW5W + BB98R	FW5S + BB98R	FW5O + BB98R	FW5G + BB98R
1000 Curved wall hung right handed vanity unit with doors & Minerva® Carrara white with right hand vanity bowl	RH 2 Door	980	550	510	590	FW5W + BC98R	FW5S + BC98R	FW5O + BC98R	FW5G + BC98R

Nickel handles sold as individual product

Select your basin style

Choose between our three different worktop designs.



Minerva® Carrara white with vanity bowl



Minerva® white with vanity bowl



Minerva® black granite with vanity bowl

Select your unit colour

Choose from our four colours in either the left or right hand unit.



1000 Curved wall left / right unit in matt white with Minerva® white bowl



1000 Curved wall left / right unit in sand with Minerva® white bowl



1000 Curved wall left / right unit in dark olive with Minerva® white bowl



1000 Curved wall left / right unit in classic grey with Minerva® white bowl



HDP



DIMENSIONS



TAP HOLES



STAINING



MINERVA® CARE KIT



MINOR SCRATCHING



ROUTINE CLEANING

fitted furniture



Why not paint your own?
See page 115.



600mm mirrored double door wall unit F6MW



300mm single door wall unit F3WW



600mm double door wall unit F6WW



Soft close seat chrome hinge, matt white S45



600mm basin base unit for semi recessed basin with semi recessed 580mm basin base unit F6BW Basin B12



300mm single door base unit base unit F30W



600mm wall hung WC unit with lever flush cistern WC unit W60W Wall hung WC pan P10 Steel frame W33A



Minerva® Carrara white 1200mm worktop BW305



Minerva® Joint Kit, white MVCA

All Burlington furniture pieces are made using a dowel and KD screw joining system for exceptional strength. And you can guarantee we've thought of everything for simple installation and sublime style. Cut out drawers allow for under-counter basin pipework without compromising on space. While spacious work surfaces, glass shelves and soft-close features add luxurious finishes that elevate your bathroom to one of superior quality.

fitted furniture



Why not paint your own?
See page 115.



600mm mirrored double door wall unit **F6MS**



2x 600mm double door wall unit **F6WS**



Soft close seat chrome hinge, sand **S43**



600mm basin base unit for semi recessed basin with semi recessed 580mm basin base unit **F6BS**
Basin **B12**



600mm double door base unit base unit **F60S**



600mm back to wall WC unit with lever flush cistern WC unit **W60S**
Wall hung WC pan **P14**



300mm tall two door base unit **F3TS**



Minerva® Joint Kit white **MVCA**



Minerva® white 1200mm worktop **BW305**

The Burlington fitted furniture collection is an ingenious system of individual units fitted together to give the illusion of space and maximise functionality in your bathroom. Choose from four painted colours or paint your own using our recommended paint options and pair with one of our solid surface worktops shown on page 114.

WALL FURNITURE



600mm Double door wall unit
W 600 D 150 H 750

F6W*



300mm Single door wall unit
W 300 D 150 H 750

F3W*



600mm Mirrored double door wall unit
W 600 D 150 H 750

F6M*



300mm Mirrored single door wall unit
W 300 D 150 H 750

F3M*

FLOOR FURNITURE



600mm Basin base unit for semi recessed basin
Unit W 600 D 300 H 850
Basin W 480 D 580 H 1950

UNIT F6B*
BASIN B12



600mm Back to wall WC unit with lever and back to wall pan
Unit W 600 D 300 H 850
WC W 365 D 480 H 420

UNIT W60*
WC PAN P14
SEAT S18



600mm Back to wall WC unit with lever and regal back to wall pan
Unit W 600 D 300 H 850
WC W 365 D 480 H 420

UNIT W60*
WC PAN P15
SEAT S18



600mm Double door base unit
W 600 D 300 H 850

F60*



300mm Single door base unit
W 300 D 300 H 850

F30W*



Plumbing cover in matt grey
W 300 D 150 H 750

X02G



300mm Tall two door base unit
W 300 D 300 H 1910

F3T*

WC SEATS



Chrome soft close matt white seat

SEAT S45**
HANDLE A51CHR

WORKTOPS



Minerva® Carrara white 120cm
W 1200 D 305 H 25

BC305



Minerva® white 120cm
W 1200 D 305 H 25

BW305



Minerva® black granite 120cm
W 1200 D 305 H 25

BB305

MIRRORS



Framed 600 mirror with LED illumination
W 600 D 40 H 750

M6M*



Framed 900 mirror with LED illumination
W 900 D 40 H 750

M9M*



Framed 1200 mirror with LED illumination
W 1200 D 40 H 750

M12M*



Framed 600 mirror
W 600 D 40 H 750

M6O*



Framed 900 mirror
W 900 D 40 H 750

M9O*



Framed 1200 mirror
W 1200 D 40 H 750

M12O*

* All furniture units are available in matt white, sand or dark olive. To order the correct colour simply replace '**' with W, S, O or G.

** To change seat colour use S43 for sand, S44 for dark olive and S46 for classic grey.
Nickel handles sold as individual product



*B*urlington bathrooms now offer a new range of baths each with panels or surrounds in corresponding colours to your furniture, transforming your entire bathroom into a space of peace and tranquillity with a subtle, traditionally British feel.

· LEFT · Arundel 750mm bath, Arundel 750 bath end panel and Arundel 1700 bath side panel with Claremont deck mounted bath shower mixer with 'S' adjuster. · TOP · London Back To Wall Bath with Dark Olive Curved Surround including overflow & waste, deck mounted Claremont Regent bath shower mixer.

All measurements are represented in mm. For detailed dimensions see burlingtonbathrooms.com



London Bath with sand curved surround including overflow & waste, deck mounted Birkenhead bath shower mixer, stand pipes including horizontal support bar.

London Bath

Bath	Furniture						
	Dimensions			Surround			
				Matt White	Sand	Dark Olive	Classic Grey
Length	Width	Height	Code	Code	Code	Code	
London bath with curved surround including overflow & waste in matt white	1800	850	600	E22W	E22S	E22O	E22G
London back to wall bath with curved surround including overflow & waste in matt white	1800	950	600	E23W	E23S	E23O	E23G

*London bath is supplied with overflow and fitted waste.

Select your style

Choose between our two London furniture baths.



London bath with curved surround



London back to wall bath with curved surround

Choose your colour

Choose between matt white, sand, dark olive or classic grey.



London bath with matt white surround



London bath with sand surround



London bath with dark olive surround



London bath with classic grey surround



HDP



DIMENSIONS



TAP HOLES



STAINING



MINERVA®
CARE KIT



MINOR
SCRATCHING



ROUTINE
CLEANING



Arundel 700mm bath, Arundel 700 bath end panel and Arundel 1700 bath side panel with Claremont deck mounted bath shower mixer.

Arundel Bath

Bath	Furniture							
	Dimensions			Panels				Grips
				Matt White	Sand	Dark Olive	Classic Grey	
Length	Width	Height	Code	Code	Code	Code	Code	
Arundel bath 1700 x 700 with adjustable legs	1700	700	440	E28 + E24FW + E25EW	E28 + E24FS + E25ES	E28 + E24FO + E25EO	E28 + E24FG + E25EG	R30 R37
Arundel bath 1700 x 750 with adjustable legs	1700	750	440	E30 + E24FW + E26EW	E30 + E24FS + E26ES	E30 + E24FO + E26EO	E30 + E24FG + E26EG	R30 R37

Choose your bath size

Choose from our two Arundel baths.

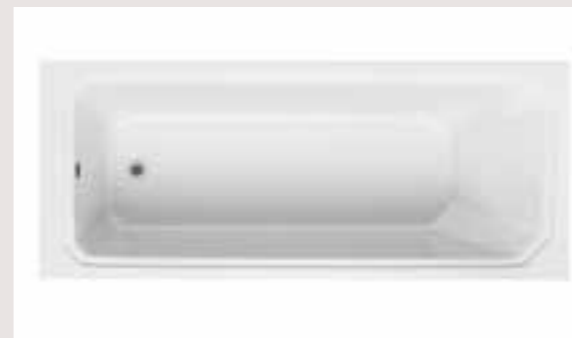

Arundel bath 700



Arundel bath 750

Select your bath grips

Choose from either our luxury or standard bath grips.



Luxury bath grips



Standard bath grips

Select your colour

Choose from our four colours: matt white, sand, dark olive or classic grey.



Matt white

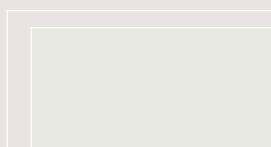

Sand



Dark olive



Classic grey



HDP



DIMENSIONS



TAP HOLES



STAINING



MINERVA CARE KIT



MINOR SCRATCHING



ROUTINE CLEANING

minerva worktops



Minerva® worktops are available from stock in either pristine Minerva® white, elegant Minerva® Carrara white or opulent Minerva® black granite. You can choose from our other 11 unique décor options, available to order with longer custom delivery times for the ultimate personalised look, ask your local specialist Burlington dealer.



Minerva® care kit

BCARE



Minerva® joint kit

WHITE MVWH
BLACK GRANITE MVBG
CARRARA WHITE MVCA

paint your own



Should you wish, our matt white furniture is supplied ready for you to paint, so you can transform your entire bathroom to your individual colour scheme. We've chosen some Farrow & Ball colours as suggestions displayed below. We recommend cleaning the unit to ensure you have a clean and grease free surface before painting with an egg shell paint for the best effect.



Baths

The Burlington range of free-standing baths offers beautifully crafted exclusivity in a variety of styles to suit both modern and traditional spaces. Choose from soaking tubs, exclusive traditional baths with a range of feet in six styles and three colours to personalise your bath to your individual tastes and bathroom décor. All the baths are made using the highest quality techniques and processes to ensure the finished product will provide many years of blissful bathing. There are three exceptional Natural Stone baths for that extra piece of luxury in your bathroom. Whichever bath from our extensive range you choose, you are assured of the finest quality.

Baths



TSFR · The baths are made from Twinned Skinned Fused Reinforced acrylic. This material is both strong and hard wearing whilst being lightweight making the Burlington bath the perfect option for your bathroom.



WEIGHT · The weight of the bath when stood empty.



WEIGHT CAPACITY · Capacity available for the bath when empty.



WEIGHT CAPACITY WITH PERSON IN IT · Capacity of the bath when person is sitting in the bath.



The Bateau bath is a beautiful example of a classic roll top with a stylish presence.

Provided in white, this bath was primed and painted a deep sea blue to match its surroundings. The Chrome feet provide an eye-catching focal point in the bathroom.

· ALL · Bateau bath with Chrome Arc feet. Burlington Claremont floor-standing bath shower mixer plug and chain waste, P-trap and P-trap connection pipe.

Note: The Bateau bath comes in a white finish. The exterior can be primed and painted. The photograph shows the bath in Fired Earth Carbon Blue. If you wish to paint yours then please note this is only possible on TSFR baths. You should seek advice from the paint manufacturer for suitable primers and processes.



Bateau double ended 1700mm bath
W 700 L 1640 H 720

BATH T10F



STANDARD LEGS
LUXURY LEGS

Compatible wastes
CW3, W4, CW6, W21

Tap Hole Options
Not suitable for rim mounted taps

Overflow
Pre-drilled

Feet Options
See pages 146-147 (bath shown with L2C legs)

windsor



The Windsor bath is a gorgeous example of a traditional roll top bath with perfectly formed curved and flowing lines. Being double-ended with gradually sloping sides it allows for luxurious bathing. Windsor baths are available in 1500mm and 1700mm.



Windsor double ended 1500 / 1700mm bath
 1500mm W 750 L 1500 H 630
 1700mm W 750 L 1700 H 630

1500MM E4



1700MM E3



STANDARD LEGS
 LUXURY LEGS

Compatible wastes
 CW2, CW3, W4, W21, W8N

Tap Hole Options
 0, 1, 2 (supplied with template, undrilled)

Overflow
 Supplied with template, undrilled

Feet Options
 See pages 146-147 (bath shown with LTC legs)

· ALL · Windsor 1700mm bath with luxury chrome claw feet and Claremont deck-mounted angled bath shower mixer, decorative shrouds, exposed chrome waste and overflow, P trap and P trap connection pipe.

brindley



This Brindley tub is an elegant addition to any bathroom and provides the perfect excuse for a leisurely soak. Its smooth curves, paired with traditional brassware for subtle style, will enhance any setting.



Brindley double ended bath with surround
W 750 L 1700 H 670

BATH E5.E12



Compatible wastes
CW2, W3

Tap Hole Options
Not suitable for rim mounted taps

Overflow
Supplied with template, undrilled

· ALL · Brindley soaking tub and skirt with Claremont floor-standing bath shower mixer, plug and chain waste.

All measurements are represented in mm. For detailed dimensions see burlingtonbathrooms.com

london rectangular



*M*ake a statement with the London Rectangular, shown here primed and painted in silver to create the perfect centrepiece to a stunning bathroom. Its grand structure allows for generous internal capacity, allowing for comfort as well as style.



London Rectangular double ended bath
W 850 L 1800 H 640

BATH E19



Compatible wastes
Pre fitted with a waste

Tap Hole Options
Not suitable for rim mounted taps

Overflow
Pre drilled

· ALL · London rectangular soaking tub with Claremont floor-standing bath shower mixer.

Note: The London Rectangular bath comes in a white finish. The exterior can be primed and painted. The photograph shows the bath in Craig & Rose paint in Sensual Silver. If you wish to paint yours then please note this is only possible on TSFR baths. You should seek advice from the paint manufacturer for suitable primers and processes.

All measurements are represented in mm. For detailed dimensions see burlingtonbathrooms.com

london round



The double-ended London Round has a simple purity of form that will enhance any style of décor in your home. Shown here paired with traditional brassware for a timeless aesthetic.



London Round double ended bath
W 850 L 1800 H 640

BATH E18



Compatible wastes
Pre fitted with a waste

Tap Hole Options
Not suitable for rim mounted taps

Overflow
Pre drilled

· LEFT · London round soaking tub with Claremont floor-standing bath shower mixer.

All measurements are represented in mm. For detailed dimensions see burlingtonbathrooms.com

admiral



This stunning, dramatic bath will provide a gorgeous centrepiece in any bathroom. Its grand appearance and imposing structure deserves to be the centre of attention. The Admiral bath also comes in two sizes, a 1800mm length and a 1650mm for reduced space.



Admiral double ended 1650 / 1800 bath

1650mm W 710 L 1650 H 710
1800mm W 890 L 1800 H 750

1650MM ET5C



1800MM ET6C



Compatible wastes
CW3, W4, CW6

Overflow
Pre drilled

Tap Hole Options
Not suitable for rim mounted taps

· ALL · Admiral 1800mm bath with Birkenhead floor-standing bath shower mixer and exposed chrome waste and overflow.

All measurements are represented in mm. For detailed dimensions see burlingtonbathrooms.com

Buckingham



The Buckingham is a simple and stylish example of the slipper bath, with its raised end angled perfectly to support you for the ultimate comfortable bathe.



Buckingham 1500mm slipper bath
W 730 L 1500 H 630

BATH E6



STANDARD LEGS
LUXURY LEGS

Compatible wastes
CW2, CW3, W4, W21, W8N

Tap Hole Options
0, 1, 2 (supplied with template, undrilled)

Overflow
Supplied with template, undrilled

Feet Options
See pages 146-147 (bath shown with L3C legs)

· LEFT · Buckingham Bath with luxury white arc feet, Claremont angled deck-mounted bath shower mixer with decorative shrouds.

harewood



The raised end of this stunning slipper bath is angled perfectly to support you and provide a luxurious bathe. Pair with beautifully traditional brassware and optional decorative shrouds for a unified classic look.



Harewood 1700mm slipper bath
W 730 L 1700 H 630

BATH E1



STANDARD LEGS
LUXURY LEGS

Compatible wastes
CW2, CW3, W4, W21, W8N

Tap Hole Options
0, 1, 2 (supplied with template, undrilled)

Overflow
Supplied with template, undrilled
Feet Options
See pages 146-147 (bath shown with L3C legs)

· LEFT · Harewood bath with standard chrome traditional legs with Angelesey deck-mounted bath shower mixer with decorative shrouds.

emperor



A tall and impressive bath; the emperor has a deep, regal stature which will act as a show piece in your bathroom, yet its angled internal base also provides exceptional comfort and support for a tranquil bathe.



Emperor slipper bath
W 780 L 1530 H 780

BATH ET13B



Compatible wastes
CW2, CW3, W4, CW6, W21

Tap Hole Options
Not suitable for rim mounted taps

Overflow
Supplied with template, undrilled

· LEFT · Emperor bath with Claremont floor-standing bath shower mixer and click-clack waste.

All measurements are represented in mm. For detailed dimensions see burlingtonbathrooms.com

avantgarde



The Avantgarde is a double ended option fitted against the wall. This is a functional option for those with a little less space but still looking for the luxury of a free standing bath. Pair with deck mounted taps or wall mounted for a high end and sleek appearance.



Avantgarde slipper bath
W 750 L 1700 H 630

BATH T12D



STANDARD LEGS
LUXURY LEGS

Compatible wastes
CW2, CW3, W4, CW6, W21

Tap Hole Options
0, 1, 2 (supplied with template, undrilled)

Overflow
Supplied with template, undrilled

Feet Options
See pages 146-147 (bath shown with L1C legs)

· ALL · Avantgarde bath shown with deck mounted bath shower mixer

Blenheim



An elegant and simple shape providing timeless design and beautiful aesthetic. A classic addition to any traditionally styled bathroom. Keep simple with stylish feet in a chrome finish for a seamless and subtle look.



Blenheim single ended bath
W 750 L 1700 H 640

BATH E2



STANDARD LEGS
LUXURY LEGS

Compatible wastes
CW2, CW3, W4, W21, W8N

Tap hole options
0, 1, 2 (supplied with template,
undrilled)

Overflow
Supplied with template, undrilled

Feet options
See pages 146-147 (bath shown with
L3C legs)

· ALL · Blenheim single ended with standard classical legs, Birkenhead deck-mounted bath shower mixer, decorative shrouds, exposed chrome waste and overflow, P trap and P trap connection pipe.

arundel



The Arundel is available in two size options and can be fitted as part of a showering bath or in a more central position in the bathroom, as shown (left) or tiled in to fit with your bathroom design. The Arundel is versatile and can be incorporated in to any bathroom scheme including those with fitted or free-standing furniture in each of the four Burlington colourways.



Arundel 700 / 750 bath
 700mm W 700 L 1700 H 580
 750mm W 750 L 1700 H 580

700MM E28



750MM E30



Compatible wastes
 W4

Compatible bathscreens
 C9, C10

Compatible bath grips
 R30, R37

Tap hole options
 Undrilled

Overflow
 Overflow hole is pre drilled

Bath panels
 See pages 112 & 113

- LEFT - Arundel 700mm bath, Arundel 700 bath end panel and Arundel 1700 bath side panel with Claremont deck mounted bath shower mixer.
- TOP - Arundel 750mm bath, Arundel 750 bath end panel and Arundel 1700 bath side panel with Claremont deck mounted bath shower mixer with 'S' adjuster.

showering over a bath



For those with a slightly smaller space wanting to make the most out of their bathrooms why not choose a shower bath. This offers flexibility and ensures the bathroom remains stylish yet versatile for those wanting to bathe and shower.

· LEFT · Hampton 1500mm right handed bath with luxury bath legs and a bathscreen with access panel.



Water saving air-boosted shower head

hampton



Bathscreen with access panel



Single bathscreen

Bathscreens

Single W 850 H 1450
Access W 850 H 1450

SINGLE BATHSCREEN
1450MM C9



WITH ACCESS PANEL
1450MM C10



The Hampton showering bath is available in either right or left hand options and gives great flexibility to those who may wish to have both bathing and showering options available to them. Simply place into a corner and pair with our innovative bath screen with access panel, allowing you to turn on the shower, before getting in, without getting wet.

· LEFT · Hampton 1500mm left handed bath with luxury bath legs and a single bathscreen.



Hampton 1500 / 1700 right & left handed bath

1500mm W 750 L 1500 H 650
1700mm W 750 L 1700 H 650

RIGHT 1500MM E21
LEFT 1500MM E20



RIGHT 1700MM E14
LEFT 1700MM E13



STANDARD LEGS
LUXURY LEGS

Compatible wastes
W4

Compatible bathscreens
C9, C10

Compatible bath grips
R30, R37

Tap hole options
Undrilled

Overflow
Overflow hole is pre drilled

Feet options
See pages 146-147 (bath shown
with L3C legs)

bath feet

LUXURY BATH FEET



Claw feet

CHROME L1C
WHITE L1W
BLACK L1B



Arc feet

CHROME L2C
WHITE L2W
BLACK L2B



Classic feet

CHROME L3C
WHITE L3W
BLACK L3B

STANDARD BATH FEET



Traditional feet

CHROME E11 CHR
WHITE E11 WHI
BLACK E11 BLA



Classical feet

CHROME E10 CHR
WHITE E10 WHI
BLACK E10 BLA



Period feet

CHROME E9 CHR
WHITE E9 WHI
BLACK E9 BLA

stand pipes and shrouds



Stand pipes including horizontal support bar
W 280 D 100 H 600

W7
These are for use with baths where fittings are not rim or wall-mounted (Water runs through the pipes). Can be used with deck-mounted taps.



Decorative shrouds
W 70 D 70 H 710

W6
These are for use with baths with rim-mounted fittings and can be used with deck-mounted taps.





Brassware

The Brassware is packed full of innovative technology, not seen amongst other traditional competitors. Every Burlington tap is supplied with a flow straightener for areas with low water pressure and an aerator for areas with high water pressure. This, unlike most traditional taps, ensures your water is delivered at 13 litres per minute regardless of incoming water pressure. So you no longer have to cope with water splashing everywhere, the flow from a Burlington tap is perfect every time.

All bath fillers and bath shower mixers have rotating spouts so you can move the brassware out of the way to enjoy a relaxing bathe. Every bath shower mixer also comes with an 'S' Adjuster, allowing you to position the handset over the bath. You can install your bath shower mixer with or without this feature. All are also available as an angled option, so you see the indices when you walk into the room. Bridge basin mixer spouts also swivel to allow you to turn your tap into a drinking fountain.

Burlington taps

Burlington is the first British Traditional designed range available that enables water savings! In the UK some homes have low water pressure and some have high water pressure. We supply every tap with two Neoperl devices: A flow straightener which is for use with low water pressures and an aerator which is for use with high water pressures.

Our taps are designed to deliver the following maximum flows of water, regardless of the incoming water pressure:

Basin taps	13 litres per minute
Bath tap	14 litres per minute
Bath shower mixer	22 litres per minute

NORMAL SPOUT

The underside of a bath spout of a normal, traditional bath tap.



BURLINGTON SPOUT

The underside of a Burlington bath tap with a Neoperl aerator



NORMAL TAP
Water flow in a normal traditional tap



LOW PRESSURE
Low pressure water flow with a Burlington tap using a flow straightener



HIGH PRESSURE
High pressure water flow with a Burlington tap using an aerator



SWIVELLING SPOUTS

All our Bath Fillers and Bath Shower Mixer spouts swivel - so you don't have the spout in your way when you shower.



ANGLED MIXERS

All our Bath Fillers and Bath Shower Mixers are available in an "angled" version.

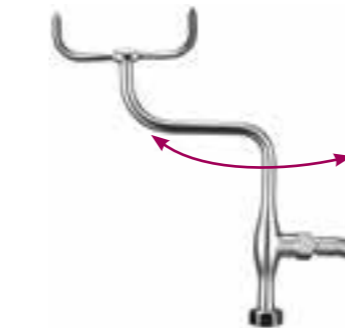

'S' ADJUSTERS

The S adjuster allows the telephone handset to be positioned over the bath - when you are done it drips into the bath. The bath shower mixer can be installed with or without the "S Adjuster".

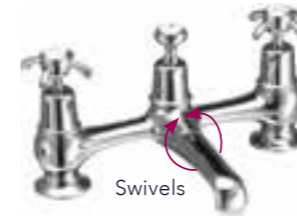

BRIDGE MIXERS

Our Bridge Basin Mixer has a swivelling spout and allows you to have mixed hot & cold water, whilst using a two taphole configuration.

- Straight down
- 90° left or right
- Straight up
- Normal basin mixer
- Off



VALVE OPTIONS

All Burlington taps are available with traditional screw-down valves or with quarter-turn valves. The taps work with both low and high pressure. See our technical website www.bbwhitebook.com for details.

Burlington taps



QUARTER TURN

All our taps (except Kensington) come with the traditional screw down valves as standard. For 'Quarter Turn' simply add QT to the product code.



Traditional
screw-down



Quarter
turn

ORDERING YOUR TAPS

When ordering your taps add the correct code to the start of the tap code

Anglesey add AN
Claremont add CL
Birkenhead add BI
Kensington add KE

CLAREMONT

A classic favourite from Burlington. This simple range of tap heads suits all basin, bath and bidet taps in the Burlington range. Pair with a deck mounted bath shower mixer for classical styling.



CLAREMONT REGENT

If looking for a little extra when choosing your brassware, opt for the regent range. A shapely stylish base suitable for all one, two and three tap hole taps excluding Chelsea and Stafford.



ANGLESEY

Pair the Anglesey tap head range with our Burlington contemporary range of basins.



ANGLESEY REGENT

The Anglesey is also available with the regent tap base to offer extra height to your tap. Pair with any of the Burlington basins.

BIRKENHEAD

The Birkenhead taps work well with any of our basins or baths and look particularly beautiful on our range of classic baths.



BIRKENHEAD REGENT

Also available with the regent option in the Birkenhead tap head. For something striking in your bathroom, this is the perfect choice.



KENSINGTON

Burlington's Kensington range of tap heads offers opulence and sophistication. Taking inspiration from a bygone era the Kensington brings a traditional style with modern technology.



KENSINGTON REGENT

Add the regent base to this tap style for an extravagant appearance - particularly suited to the Edwardian basins.

Introducing *black*

Introducing a black indice option from Burlington, you can now pair nearly all of our brassware options with a black indice instead of the classic white. This allows for a variation between the classic styling and a modern take on the existing options.

The brassware options can be paired with various accessories including radiators, bath wastes and even our showering range.

Look for the BLA codes throughout the brochure.

Available late Spring 2018.

ORDERING YOUR TAPS

When ordering your black taps add BLA to the end of the code as shown on pages 156, 158, 161, and 164.



basin taps

black option

ONE TAP HOLE



Basin mixer with high central indice with click clack waste

CL6 BLA
REGENT CLR6 BLA



Basin mixer with high central indice with pop up waste

CL4 BLA
REGENT CLR4 BLA



Basin mixer with high central indice with plug and chain waste

CL5 BLA
REGENT CLR5 BLA



Basin mixer with high central indice with pop up waste

CL13 BLA
REGENT CLR13 BLA

TWO TAP HOLE



Basin tap 3"

CL1 BLA
REGENT CLR1 BLA



Basin tap 5"

CL2 BLA
REGENT CLR2 BLA



Two tap hole bridge mixer with swivelling spout with plug and chain waste

CL10 BLA
REGENT CLR10 BLA



Two tap hole arch mixer with curved spout (200mm centres)

CL27 BLA
REGENT CLR27 BLA

THREE TAP HOLE



Three tap hole mixer with pop up waste

CL12 BLA
REGENT CLR12 BLA

ORDERING YOUR TAPS

When ordering your taps add the correct code to the start of the tap code

Anglesey add AN
Claremont add CL
Birkenhead add BI
Kensington add KE



Two tap hole arch mixer with curved spout (230mm centres)

CL28 BLA
REGENT CLR28 BLA

basin taps

white option

ONE TAP HOLE



Basin mixer with high central indice with click clack waste

CL6
REGENT CLR6



Basin mixer with high central indice with pop up waste

CL4
REGENT CLR4



Basin mixer with high central indice with plug and chain waste

CL5
REGENT CLR5



Basin mixer with high central indice with pop up waste

CL13
REGENT CLR13

TWO TAP HOLE



Basin tap 3"

CL1
REGENT CLR1



Basin tap 5"

CL2
REGENT CLR2



Two tap hole bridge mixer with swivelling spout with plug and chain waste

CL10
REGENT CLR10



Two tap hole arch mixer with curved spout (200mm centres)

CL27
REGENT CLR27

THREE TAP HOLE



Three tap hole mixer with pop up waste

CL12
REGENT CLR12



Two tap hole arch mixer with curved spout (230mm centres)

CL28
REGENT CLR28

bath taps

black option

DECK MOUNTED



Bath shower mixer deck mounted with 'S' adjuster

CL15 BLA
REGENT CLR15 BLA



Bath filler deck mounted

CL23 BLA
REGENT CLR23 BLA



Bath tap deck mounted

CL3 BLA
REGENT CLR3 BLA

WALL MOUNTED



Bath shower mixer wall mounted with 'S' adjuster

CL17 BLA
REGENT CLR17 BLA



Bath filler wall mounted

CL24 BLA
REGENT CLR24 BLA

ORDERING YOUR TAPS

When ordering your taps add the correct code to the start of the tap code

Anglesey add AN
Claremont add CL
Birkenhead add BI
Kensington add KE

bath taps

white option

DECK MOUNTED



Bath shower mixer deck mounted with 'S' adjuster

CL15
REGENT CLR15



Bath filler deck mounted

CL23
REGENT CLR23



Bath tap deck mounted

CL3
REGENT CLR3

WALL MOUNTED



Bath shower mixer wall mounted with 'S' adjuster

CL17
REGENT CLR17



Bath filler wall mounted

CL24
REGENT CLR24

ORDERING YOUR TAPS

When ordering your taps add the correct code to the start of the tap code

Anglesey add AN
Claremont add CL
Birkenhead add BI
Kensington add KE

thermostatic



Match your basin, bath and shower with the convenience and safety of thermostatic controls for your bathroom.



3 tap hole bath shower mixer with pop up waste

CL29 BLA



Bath shower mixer deck mounted with 'S' adjuster

T2DB BLA



Thermostatic two outlet twin control bath shower mixer valve

BT2DS BLA+V16



3 tap hole bath shower mixer with pop up waste

CL29



Bath shower mixer deck mounted with 'S' adjuster

T2DB



Thermostatic two outlet twin control bath shower mixer valve

BT2DS + V16

ORDERING YOUR TAPS

When ordering your taps add the correct code to the start of the tap code

- Anglesey add AN
- Claremont add CL
- Birkenhead add BI
- Kensington add KE

Stafford



ORDERING YOUR TAPS

When ordering your taps add the correct code to the start of the tap code

Anglesey add AN
Claremont add CL
Birkenhead add BI
Kensington add KE



Stafford bath pillar taps

STA13



Stafford long nose basin pillar taps

STA12



Stafford mono basin mixer with pop up waste

STA11



Stafford bath shower mixer deck mounted

STA14
Please note that the Stafford does not include an 'S' adjuster.



Chelsea straight basin mixer with pop up waste

CH20



Chelsea curved basin mixer without waste

CH21



Chelsea curved basin mixer with pop up waste

CH22



Chelsea curved bidet mixer with pop up waste

CH23



Chelsea straight basin mixer with pop up waste

CH20 BLA



Chelsea curved basin mixer without waste

CH21 BLA



Chelsea curved basin mixer with pop up waste

CH22 BLA



Chelsea curved bidet mixer with pop up waste

CH23 BLA



Chelsea straight basin mixer without waste

CH19



Chelsea straight tall basin mixer without waste

CHE1



Chelsea curved tall basin mixer without waste

CHE2



Chelsea straight basin mixer without waste

CH19 BLA



Chelsea straight tall basin mixer without waste

CHE1 BLA



Chelsea curved tall basin mixer without waste

CHE2 BLA

ORDERING YOUR TAPS

When ordering your taps add the correct code to the start of the tap code

- Anglesey add AN
- Claremont add CL
- Birkenhead add BI
- Kensington add KE

FOR BATHS



Shallow p trap

CW3



Bath overflow plug and chain

W3



Bath overflow plug and chain

W3 BLA



P trap connection pipe

W21

FOR BASINS



Flat bottom bottle trap

W13



Traditional bottle trap

W14



Flip top basin waste, slotted, chrome

W18



Tap hole stopper, chrome

A49 CHR



Overflow filler for single / double ended baths

SINGLE W15
DOUBLE W2



Overflow filler for single ended baths

SINGLE W15 BLA



Click clack bath waste (slotted) with chrome cover

CW1
For use with internal overflow bath



Click clack bath waste (unslotted) with chrome cover

CW2
For use without internal overflow bath



Click clack (push button) basin waste

W11



Basin plug and chain, slotted

W1



Burlington basin tap shut off valves (hot/cold)
W 348 D 64 H 112

W28



Burlington basin tap shut off valves (hot/cold)
W 348 D 64 H 112

W28 BLA



Special bath waste without a pre drilled overflow hole

CW11
With unslotted click clack waste



Exposed bath overflow, click clack waste

CW6



Exposed bath overflow, plug and chain

W4



Exposed bath overflow, plug and chain

W4 BLA

FOR BIDETS



Bidet trap

W27

FOR WCS



Cistern tank on/off valve

W25



Cistern tank on/off valve

W25 BLA

FOR SHOWERS



Angled connector for telephone handset, chrome

V62

Showering

The Burlington range of showers provides extensive options so you can create a showering solution for your own bespoke setting. Whether you prefer showering over a bath or in an enclosure, Burlington has a solution for your own requirements. Thermostatic valves offer safe and controllable showering for the entire family. Shower valves and brassware features polished chrome, enhanced by timeless white ceramic, to both look fantastic and be ergonomic to use. Designed using the highest quality materials to achieve yesterday's designs with today's technology, you are ensured a great showering experience.

Now introducing the Digital range of showering the Classic 1910 options provide a higher level of showering options for those looking for the latest technology in their classic Burlington bathroom.



THERMOSTATIC SAFETY / ANTI LIMESCALE · We use Vernet wax capsules throughout our showering valves, meaning temperature when showering will now vary by more than +/- 1°C. The quality materials minimise potential limescale effects enabling extended lifetimes.



CERAMIC DISC TECHNOLOGY · Burlington offers ceramic disc technology across its showering range.



ONE WAY WATER · Our non-return valves ensure the flow of water in only one direction, ensuring heating efficiency, preventing siphonage of contaminated water and keeping your shower cartridge in excellent condition for longer.



AIRBURST · By combining air and water, the pressure inside the shower head is increased. The power of a traditional shower with up to 33% water saved.



NEW BLACK LEVERS · New Black lever and handle options are now available for Burlington showering. Look for the B symbol within the showering pages where there is a black option available.

Available late Spring 2018.

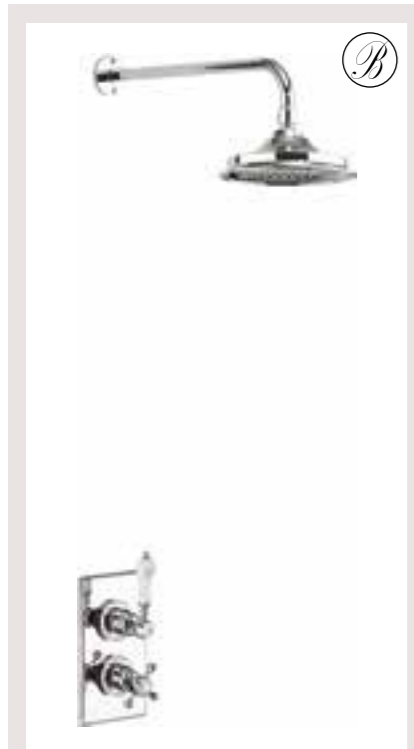

Thermostatic single function, brass valve with independent temperature control

Traditional brass faceplate, Claremont handle with ceramic lever

390mm adjustable fixed shower arm

6", 9", 12" AirBurst shower head

WHITE CERAMIC

TF1S+V16
TF1S+V17
TF1S+V60

BLACK CERAMIC

TF1S BLA+V16
TF1S BLA+V17
TF1S BLA+V60



Thermostatic single function, brass valve with independent temperature control

Traditional brass faceplate, Claremont handle with ceramic lever

Slide rail including the elbow, hose and handset with ceramic handle

WHITE CERAMIC

TF1H

BLACK CERAMIC

TF1H BLA

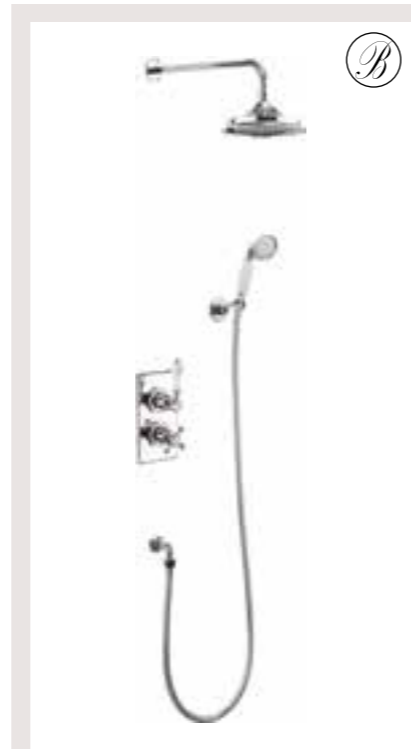

Thermostatic dual function brass valve with independent flow diverter and temperature control

Traditional brass faceplate, Claremont handle with ceramic lever

Wall outlet and 1500mm shower hose

Adjustable wall bracket and handset with ceramic handle

390mm adjustable shower arm

6", 9", 12" AirBurst shower head

WHITE CERAMIC

TF2S+V16
TF2S+V17
TF2S+V60

BLACK CERAMIC

TF2S BLA+V16
TF2S BLA+V17
TF2S BLA+V60

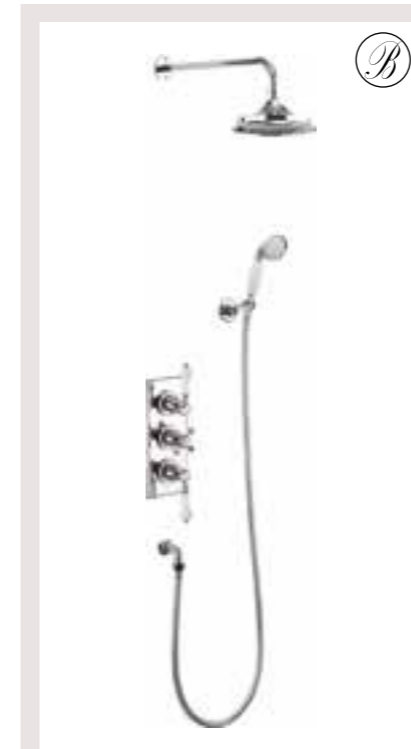

Thermostatic dual function brass valve with two independent on / off controls and central temperature control

Traditional brass faceplate, Claremont handle with ceramic lever

Wall outlet and 1500mm shower hose

Adjustable wall bracket and handset with ceramic handle

390mm adjustable shower arm

6" AirBurst shower head

WHITE CERAMIC

TF3S+V16
TF3S+V17
TF3S+V60

BLACK CERAMIC

TF3S BLA+V16
TF3S BLA+V17
TF3S BLA+V60

OPTIONS

ANGLESEY SINGLE VALVE IN WHITE OR BLACK V2 / V2 BLA



BIRKENHEAD SINGLE VALVE IN WHITE OR BLACK V3 / V3 BLA



CLAREMONT SINGLE VALVE IN BLACK V1 BLA



CRADLE V24



SOAP BASKET V23



SLIDE RAIL V33 / V33 BLA



When ordering the optional bath Spout V32 you will also need the extended riser V22, if you wish to retain the handset function you will need to order V24 and V27 products. Slide rail, cradle, soap basket and alternative valve handles can be ordered as extras. Note TF1H includes slide rail. Note that all thermostatic valves are 3 bar minimum pressure.



concealed thermostatic showers

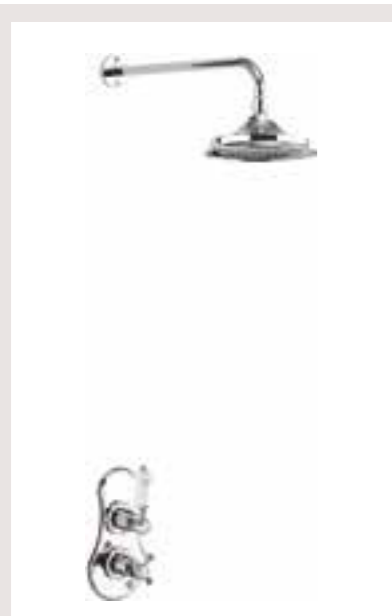

Thermostatic single function brass valve with independent temperature control

Traditional brass faceplate, Claremont handle with ceramic lever

390mm adjustable fixed shower arm

6", 9", 12" AirBurst shower head

WHITE CERAMIC

- VF1S+V16
- VF1S+V17
- VF1S+V60



THERMOSTATIC SAFETY CERAMIC DISC TECHNOLOGY



ANTI LIMESCALE ONE WAY WATER



AIRBURST

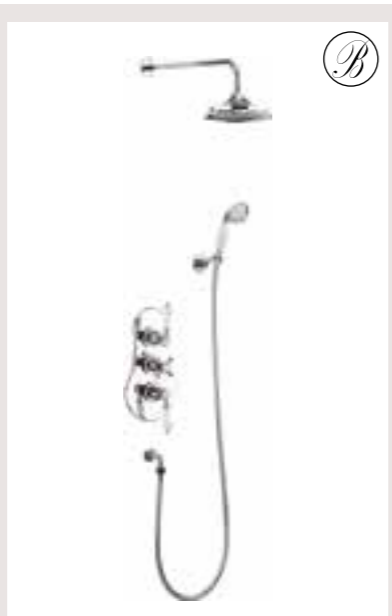

Thermostatic dual function brass valve with two independent on / off controls and central temperature control

Traditional brass faceplate, Claremont handle with ceramic lever

Wall outlet and 1500mm shower hose

Adjustable wall bracket and handset with ceramic handle

390mm adjustable shower arm

6", 9", 12" AirBurst shower head

WHITE CERAMIC

- TF2S+V16
- TF2S+V17
- TF2S+V60

BLACK CERAMIC

- TF2S BLA+V16
- TF2S BLA+V17
- TF2S BLA+V60



OPTIONS FOR SEVERN & AVON

ANGLESEY SINGLE VALVE IN WHITE OR BLACK V2 / V2 BLA



BIRKENHEAD SINGLE VALVE IN WHITE OR BLACK V3 / V3 BLA



CLAREMONT SINGLE VALVE IN BLACK V1 BLA



When ordering the optional bath Spout V32 you will also need the extended riser V22, if you wish to retain the handset function you will need to order V24 and V27 products.

exposed thermostatic showers



Thermostatic single function brass valve with independent temperature control

Traditional brass body, Claremont handle with ceramic lever

390mm adjustable fixed shower arm

6", 9", 12" AirBurst shower head

WHITE CERAMIC

- AF1S+V16
- AF1S+V17
- AF1S+V60

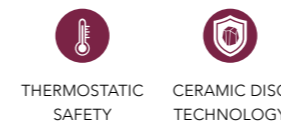

THERMOSTATIC SAFETY CERAMIC DISC TECHNOLOGY



ANTI LIMESCALE ONE WAY WATER



AIRBURST

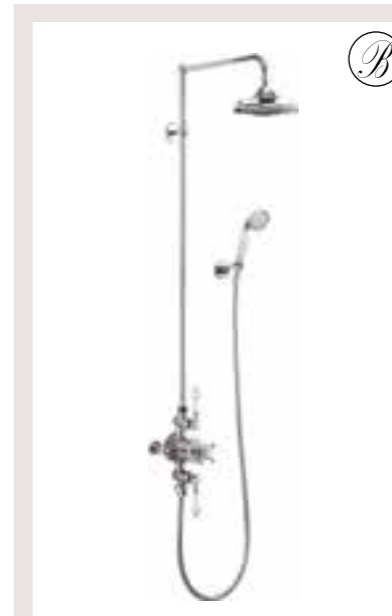

Thermostatic dual function brass valve with two independent on / off controls and central temperature control

Traditional brass body, Claremont handle with ceramic lever

Adjustable wall bracket, 1500mm shower hose and handset with ceramic handle

18mm diameter vertical brass shower riser

355mm adjustable swivel shower arm

6", 9", 12" AirBurst shower head

WHITE CERAMIC

- BAF3S+V16
- BAF3S+V17
- BAF3S+V60
- BAF3S.EXT+V16
- BAF3S.EXT+V17
- BAF3S.EXT+V60

BLACK CERAMIC

- BAF3S BLA+V16
- BAF3S BLA+V17
- BAF3S BLA+V60
- BAF3S.EXT BLA+V16
- BAF3S.EXT BLA+V17
- BAF3S.EXT BLA+V60



SHOWER HEAD HEIGHT

The standard riser pipe (V21) has a length of 856mm.

To increase the height of your shower head use the extended riser (V22) which has a length of 1814mm increasing the height by 958mm.

To order the extended riser simply add .EXT to the product code. For example BSF1S changes to BSF1S.EXT

Please see the website for details.

OPTIONS FOR SEVERN & AVON

CRADLE V24

SOAP BASKET V23



SLIDE RAIL V33 / V33 BLA



Slide rail, cradle, soap basket and alternative valve handles can be ordered as extras.

Note that all thermostatic valves are 3 bar minimum pressure.

tay

bath shower thermostatic showers

eden

exposed thermostatic showers



Thermostatic two outlet twin control bath shower mixer valve with independent flow diverter and temperature controls

Traditional brass body and Claremont handles, with ceramic indices

Brass bath spout with swivel function

Available deck or wall mounted

S connector and bracket, 1500mm shower hose and handset with ceramic handle

WHITE CERAMIC

DECK T2DB
WALL T2WB

BLACK CERAMIC

DECK T2DB BLA
WALL T2WB BLA



Thermostatic two outlet twin control bath shower mixer valve with independent flow diverter and temperature controls

Traditional brass body and Claremont handles, with ceramic indices

Brass bath spout with swivel function

Available deck or wall mounted

18mm diameter vertical brass shower riser

355mm adjustable swivel shower arm

6", 9", 12" AirBurst shower head

WHITE CERAMIC

DECK BT2DS+V16
DECK BT2DS+V17
DECK BT2DS+V60
WALL BT2WS+V16
WALL BT2WS+V17
WALL BT2WS+V60

BLACK CERAMIC

DECK BAF3S BLA+V16
DECK BAF3S BLA+V17
DECK BAF3S BLA+V60
WALL BAF3S.EXT BLA+V16
WALL BAF3S.EXT BLA+V17
WALL BAF3S.EXT BLA+V60

- THERMOSTATIC SAFETY
- CERAMIC DISC TECHNOLOGY
- ANTI LIMESCALE
- ONE WAY WATER
- AIRBURST

OPTIONS FOR TAY & EDEN

CRADLE V24



SOAP BASKET V23



SLIDE RAIL V33 / V33 BLA



Slide rail, handset, hose, diverter, cradle, soap basket and alternative valve handles can be ordered as extras. Note TF1H includes slide rail.

Note that all thermostatic valves are 3 bar minimum pressure



Thermostatic single outlet twin control valve with independent on / off flow and temperature control

Traditional brass body, Claremont handle with ceramic indices

18mm diameter vertical brass shower riser

355mm adjustable swivel shower arm

6", 9", 12" AirBurst shower head

WHITE CERAMIC

BEF1S+V16
BEF1S+V17
BEF1S+V60
BEF1S.EXT+V16
BEF1S.EXT+V17
BEF1S.EXT+V60

BLACK CERAMIC

BEF1S BLA+V16
BEF1S BLA+V17
BEF1S BLA+V60
BEF1S.EXT BLA+V16
BEF1S.EXT BLA+V17
BEF1S.EXT BLA+V60



Thermostatic two outlet twin control valve with independent flow diverter and temperature control

Traditional brass body, Claremont handle with ceramic indices

Adjustable wall bracket, 1500mm shower hose and handset with ceramic handle

18mm diameter vertical brass shower riser

355mm adjustable swivel shower arm

6", 9", 12" AirBurst shower head

WHITE CERAMIC

BEF2S+V16
BEF2S+V17
BEF2S+V60
BEF2S.EXT+V16
BEF2S.EXT+V17
BEF2S.EXT+V60

BLACK CERAMIC

BEF2S BLA+V16
BEF2S BLA+V17
BEF2S BLA+V60
BEF2S.EXT BLA+V16
BEF2S.EXT BLA+V17
BEF2S.EXT BLA+V60

SHOWER HEAD HEIGHT

The standard riser pipe (V21) has a length of 856mm.

To increase the height of your shower head use the extended riser (V22) which has a length of 1814mm increasing the height by 958mm.

To order the extended riser simply add .EXT to the product code. For example BSF1S changes to BSF1S.EXT

Please see the website for details.

OPTIONS FOR TAY & EDEN

ANGLESEY SINGLE VALVE IN WHITE OR BLACK V2 / V2 BLA



BIRKENHEAD SINGLE VALVE IN WHITE OR BLACK V3 / V3 BLA



CLAREMONT SINGLE VALVE IN BLACK V1 BLA



When ordering the optional bath Spout V32 you will also need the extended riser V22, if you wish to retain the handset function you will need to order V24 and V27 products.

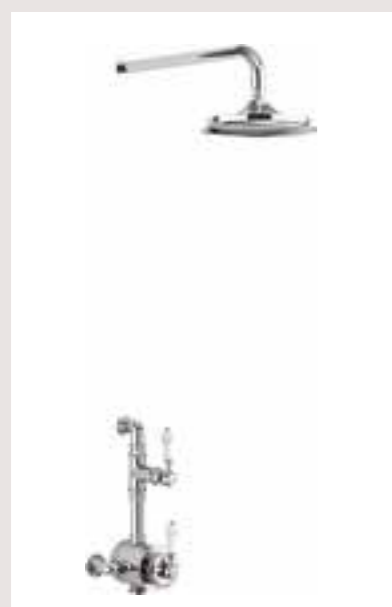

Thermostatic single function
brass valve with independent
temperature control

Traditional brass body, Claremont
handle with ceramic lever

6", 9", 12" AirBurst shower head

WHITE CERAMIC
BF1S+V16
BF1S+V17
BF1S+V60



Thermostatic single function
brass valve with independent
temperature control

Traditional brass body, Claremont
handle with ceramic lever

28mm diameter vertical brass
shower riser

450mm adjustable fixed shower arm

Soap basket

6", 9", 12" AirBurst shower head

WHITE CERAMIC
BF2S+V16
BF2S+V17
BF2S+V60



Thermostatic dual function brass
valve with two independent
on / off controls and central
temperature control

Traditional brass body, Claremont
handle with ceramic lever

Fixed cradle, 1500mm shower
hose and handset with ceramic
handle

28mm diameter vertical brass
shower riser

450mm adjustable fixed shower arm

Soap basket

6", 9", 12" AirBurst shower head

WHITE CERAMIC
BF3S+V16
BF3S+V17
BF3S+V60



THERMOSTATIC
SAFETY



AIRBURST



ONE WAY
WATER



ANTI
LIMESCALE



CERAMIC DISC
TECHNOLOGY

hinged doors

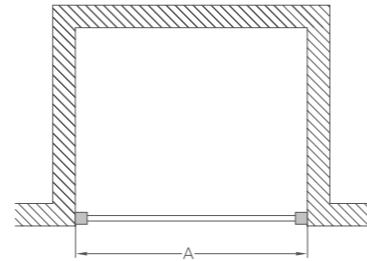

*This indicates depth of matching tray size available for use in a recessed installation.

All enclosures are 1950 high and adjustable up to 20mm from each wall.

All shower posts are constructed from aluminium and can be installed with or without chrome ball header. Safety glass is 8mm thick and 3M™ easy clean coating.

Shower tray prices exclude waste

Z1205

Size*	Adjustment	Enclosure	Tray
		Code	Code
760 x 760	720 - 760	BU1 (C19)	Z1159
800 x 800	760 - 800	BU2 (C20)	Z1160
900 x 760	860 - 900	BU3 (C21)	Z1163
900 x 800	860 - 900	BU3 (C21)	Z1164
900 x 900	860 - 900	BU3 (C21)	Z1161
900 x 1200	860 - 900	BU3 (C21)	Z1176

hinged doors and side panels

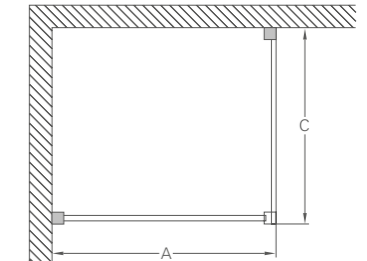

*This indicates depth of matching tray size available for use in a recessed installation.

All enclosures are 1950 high and adjustable up to 20mm from each wall.

All shower posts are constructed from aluminium and can be installed with or without chrome ball header. Safety glass is 8mm thick and 3M™ easy clean coating.

Shower tray prices exclude waste

Z1205

Size*	Adjustment	Enclosure	Tray
		Code	Code
760 x 760	730 - 750	BU11 (C19 + C12)	Z1159
760 x 900	730 - 750, 870 - 890	BU12 (C19 + C14)	Z1163
800 x 800	770 - 790	BU13 (C20 + C13)	Z1160
800 x 900	770 - 790, 870 - 890	BU14 (C20 + C14)	Z1164
900 x 760	870 - 890, 730 - 750	BU15 (C21 + C12)	Z1163
900 x 800	870 - 890, 770 - 790	BU16 (C21 + C13)	Z1164
900 x 900	870 - 890	BU17 (C21 + C14)	Z1161

hinged doors

with in line panels

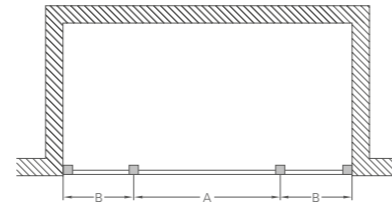

*This indicates depth of matching tray size available for use in a recessed installation.

All enclosures are 1950 high and adjustable up to 20mm from each wall.

All shower posts are constructed from aluminium and can be installed with or without chrome ball header. Safety glass is 8mm thick and 3M™ easy clean coating.

Shower tray prices exclude waste

Z1205

Size*	Adjustment	Enclosure Code	Tray Code
1000 x 700	960-1000	BU4 (C20+C15)	Z1165
1000 x 760	960-1000	BU4 (C20+C15)	Z1166
1000 x 800	960-1000	BU4 (C20+C15)	Z1167
1000 x 900	960-1000	BU4 (C20+C15)	Z1168
1000 x 1000	960-1000	BU4 (C20+C15)	Z1162
1100 x 700	1060-1100	BU5 (C20+C16)	Z1169
1100 x 760	1060-1100	BU5 (C20+C16)	Z1170
1100 x 800	1060-1100	BU5 (C20+C16)	Z1171
1100 x 900	1060-1100	BU5 (C20+C16)	Z1172
1200 x 700	1160-1200	BU6 (C20+C17)	Z1173
1200 x 760	1160-1200	BU6 (C20+C17)	Z1174
1200 x 800	1160-1200	BU6 (C20+C17)	Z1175
1200 x 900	1160-1200	BU6 (C20+C17)	Z1176
1400 x 800	1360-1400	BU7 (C20+C16+C16)	Z1177
1400 x 900	1360-1400	BU7 (C20+C16+C16)	Z1178
1500 x 700	1460-1500	BU8 (C21+C16+C16)	Z1179
1500 x 760	1460-1500	BU8 (C21+C16+C16)	Z1180
1500 x 800	1460-1500	BU8 (C21+C16+C16)	Z1181
1600 x 700	1560-1600	BU9 (C20+C17+C17)	Z1182
1700 x 700	1660-1700	BU10 (C21+C17+C17)	Z1183
1700 x 760	1660-1700	BU10 (C21+C17+C17)	Z1184
1700 x 800	1660-1700	BU10 (C21+C17+C17)	Z1185

hinged doors

with in line and side panels

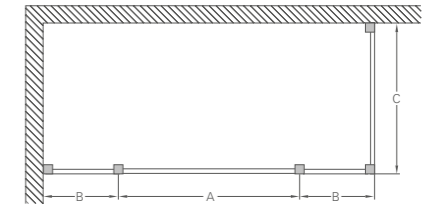

*This indicates depth of matching tray size available for use in a recessed installation.

All enclosures are 1950 high and adjustable up to 20mm from each wall.

All shower posts are constructed from aluminium and can be installed with or without chrome ball header. Safety glass is 8mm thick and 3M™ easy clean coating.

Shower tray prices exclude waste

Z1205

Size*	Adjustment	Enclosure Code	Tray Code
1000 x 760	970-990, 730-750	BU19 (C20+C15+C12)	Z1166
1000 x 800	970-990, 770-790	BU20 (C20+C15+C13)	Z1167
1000 x 900	970-990, 870-890	BU21 (C20+C15+C14)	Z1168
1100 x 760	1070-1090, 730-750	BU23 (C20+C16+C12)	Z1170
1100 x 800	1070-1090, 770-790	BU24 (C20+C16+C13)	Z1171
1100 x 900	1070-1090, 870-890	BU25 (C20+C16+C14)	Z1172
1200 x 760	1170-1190, 730-750	BU27 (C20+C17+C12)	Z1174
1200 x 800	1170-1190, 770-790	BU28 (C20+C17+C13)	Z1175
1200 x 900	1170-1190, 870-890	BU29 (C20+C17+C14)	Z1176
1400 x 800	1370-1390, 770-790	BU30 (C20+C16+C16+C13)	Z1177
1400 x 900	1370-1390, 870-890	BU31 (C20+C16+C16+C14)	Z1178
1500 x 760	1470-1490, 730-750	BU33 (C21+C16+C16+C12)	Z1180
1500 x 800	1470-1490, 770-790	BU34 (C21+C16+C16+C13)	Z1181
1700 x 760	1670-1690, 730-750	BU37 (C21+C17+C17+C12)	Z1184
1700 x 800	1670-1690, 770-790	BU38 (C21+C17+C17+C13)	Z1185

quadrants

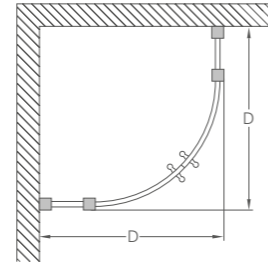

*This indicates depth of matching tray size available for use in a recessed installation.

All enclosures are 1950 high and adjustable up to 20mm from each wall.

All shower posts are constructed from aluminium and can be installed with or without chrome ball header. Safety glass is 8mm thick and 3M™ easy clean coating.

Shower tray prices exclude waste

Z1205

Size*	Adjustment	Enclosure Code	Tray Code
800 x 800	770 - 790	BU39 (C22)	Z1192
900 x 900	870 - 890	BU40 (C23)	Z1193

offset quadrants

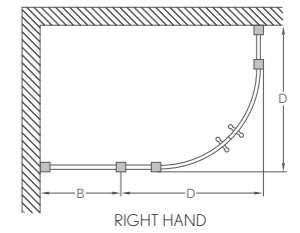
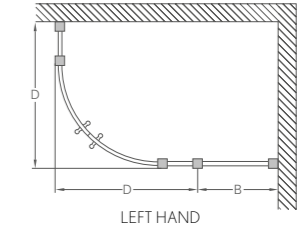

*This indicates depth of matching tray size available for use in a recessed installation.

All enclosures are 1950 high and adjustable up to 20mm from each wall.

All shower posts are constructed from aluminium and can be installed with or without chrome ball header. Safety glass is 8mm thick and 3M™ easy clean coating.

Shower tray prices exclude waste

Z1205

Size*	Adjustment	Enclosure Code	Tray Code
800 x 1000 Left hand	770 - 790, 970 - 990	BU41 (C22 + C15)	Z1199
800 x 1000 Right hand	770 - 790, 970 - 990	BU41 (C22 + C15)	Z1200
800 x 1200 Left hand	770 - 790, 1170 - 1190	BU91 (C22 + C17)	Z1201
800 x 1200 Right hand	770 - 790, 1170 - 1190	BU91 (C22 + C17)	Z1202
900 x 1200 Left hand	870 - 890, 1170 - 1190	BU42 (C23 + C16)	Z1203
900 x 1200 Right hand	870 - 890, 1170 - 1190	BU42 (C23 + C16)	Z1204

sliding doors

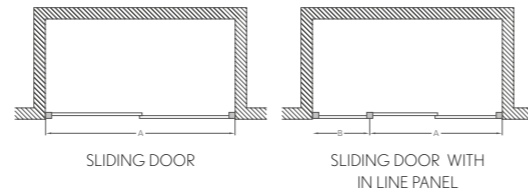

*This indicates depth of matching tray size available for use in a recessed installation. All enclosures are 1950 high and adjustable up to 20mm from each wall.

All shower posts are constructed from aluminium and can be installed with or without chrome ball header. Safety glass is 8mm thick and 3M™ easy clean coating.

Soft-close mechanisms are supplied with the door and can be fitted as an option.

Shower tray prices exclude waste

Z1205

SOFT CLOSE SLIDING DOOR

Size*	Adjustment	Enclosure Code	Tray Code
1100 x 700	1070-1090	BU68 (C6S)	Z1169
1100 x 760	1070-1090	BU68 (C6S)	Z1170
1100 x 800	1070-1090	BU68 (C6S)	Z1171
1100 x 900	1070-1090	BU68 (C6S)	Z1172
1200 x 700	1170-1190	BU69 (C7S)	Z1173
1200 x 760	1170-1190	BU69 (C7S)	Z1174
1200 x 800	1170-1190	BU69 (C7S)	Z1175
1200 x 900	1170-1190	BU69 (C7S)	Z1176
1400 x 800	1370-1390	BU70 (C8S)	Z1177
1400 x 900	1370-1390	BU70 (C8S)	Z1178

SOFT CLOSE SLIDING DOOR WITH IN LINE PANEL

Size*	Adjustment	Enclosure Code	Tray Code
1500 x 700	1470-1490	BU71 (C7S+C16)	Z1179
1500 x 760	1470-1490	BU71 (C7S+C16)	Z1180
1500 x 800	1470-1490	BU71 (C7S+C16)	Z1181
1600 x 700	1570-1590	BU72 (C8S+C15)	Z1182
1700 x 700	1670-1690	BU73 (C8S+C16)	Z1183
1700 x 760	1670-1690	BU73 (C8S+C16)	Z1184
1700 x 800	1670-1690	BU73 (C8S+C16)	Z1185

sliding doors with side panels

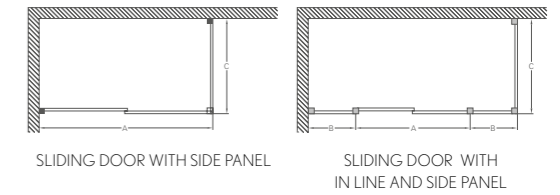

*This indicates depth of matching tray size available for use in a recessed installation. All enclosures are 1950 high and adjustable up to 20mm from each wall.

All shower posts are constructed from aluminium and can be installed with or without chrome ball header. Safety glass is 8mm thick and 3M™ easy clean coating.

Soft-close mechanisms are supplied with the door and can be fitted as an option.

Shower tray prices exclude waste

Z1205

SOFT CLOSE SLIDING DOOR WITH SIDE PANEL

Size*	Adjustment	Enclosure Code	Tray Code
1100 x 760	1070-1090, 730-750	BU75 (C6S+C12)	Z1170
1100 x 800	1070-1090, 770-790	BU76 (C6S+C13)	Z1171
1100 x 900	1070-1090, 870-890	BU77 (C6S+C14)	Z1172
1200 x 760	1170-1190, 730-750	BU79 (C7S+C12)	Z1174
1200 x 800	1170-1190, 770-790	BU80 (C7S+C13)	Z1175
1200 x 900	1170-1190, 870-890	BU81 (C7S+C14)	Z1176
1400 x 800	1370-1390, 770-790	BU82 (C8S+C13)	Z1177
1400 x 900	1370-1390, 870-890	BU83 (C8S+C14)	Z1178

SOFT CLOSE SLIDING DOOR WITH IN LINE AND SIDE PANEL

Size*	Adjustment	Enclosure Code	Tray Code
1500 x 760	1470-1490, 730-750	BU85 (C7S+C16+C12)	Z1180
1500 x 800	1470-1490, 770-790	BU86 (C7S+C16+C13)	Z1181
1700 x 760	1670-1690, 730-750	BU89 (C8S+C16+C12)	Z1184
1700 x 800	1670-1690, 770-790	BU90 (C8S+C16+C13)	Z1185

Digital



Creating the ultimate shower experience

*W*hy should you choose a digital shower? From sophisticated controls to carefully considered design, there are so many reasons.

We strive to create inspiring designs for exquisite bathrooms, and the digital shower is our latest innovation. With precise temperature technology and beautiful high-quality designs, the Bathroom Brands digital shower makes safety, simplicity, and sophistication integral to your everyday routine.

Our selection of premium product options enables you to create a showering experience individual to you and your home. Choose between single and dual shower and bath fill controls with either contemporary or classic trims, then combine with stunning fixtures from our range to achieve your ideal look. Introduce a final touch of elegance with the digital remote, a unique additional control that allows you to smoothly turn on the water and divert the flow before you even enter the shower.

Explore the benefits and key features in more detail over the following pages.

creative solutions

intuitive features

Discover the difference modern technology can make. Our digital showers offer total safety and easy installation and maintenance, with simple push button controls both inside and outside the shower.

PRECISE TEMPERATURE
Sophisticated technology gives you accurate control of the water temperature.

EASY DIVERT
Divert the flow quickly and easily with just a few touches. Press the lower control once to divert from the main showerhead to the second, and again to run both at once. On the dual bath and shower, press once to switch to showerhead, and a second time to return to bath flow.

INSTALLATION
Luxury doesn't have to be complicated. Push-fit isolation valves, a standard electrical plug fitting and easy to set up cable connections make your plumber's job simpler.



COOL-TOUCH METAL CONTROLS
Shower controls are kept completely separate from the water in the valve, which means they always stay cool and safe to touch.

COLOUR-CHANGING CONTROLS
The controls gently pulse white as the water reaches your set temperature, while a subtle, white glow lets you know the shower's ready. When you adjust the temperature the controls flash red or blue as the water heats up or cools down.

TEMPERATURE OVERRIDE
Each digital processor has a pre-set maximum temperature of 41°C, which can be overridden and adjusted to 46°C. As bath temperatures are usually higher, when you divert to the bath outlet the maximum temperature will automatically rise to 44°C.



FLEXIBLE OPTIONS
Choose from single showerhead, multiple showerhead and bath filler options. There is a solution for every bathroom.

CONSISTENT TEMPERATURE
A built-in thermistor checks the temperature 10 times every second so that, even when someone is using water elsewhere in the house, the water temperature will stay exactly the same.

AUTOMATIC SHUT OFF
If there are any problems with your water supply, the shower will shut off immediately. This provides peace of mind that your family is fully protected from hot water scalding, or the discomfort of an unexpected cold shower.

QUIET PUMP
For low-pressure installations the digital shower features an ultra quiet, integrated brushless motor, boosting performance to allow high-pressure showering with minimum noise.

REMOTE CONTROL (OPTIONAL)
Fit an optional remote control anywhere outside of the shower enclosure and within 10 metres of the digital shower. Simply press the button to turn the shower on or off, or press and hold for 1.5 seconds to divert the water flow between showerheads, or bath and shower.



CLEANING MODE
While the shower is off, set the temperature to midway between hot and cold, then press and hold the dial for 5 seconds. The light on the controller will come on to show you it's locked, then after one minute it will automatically unlock.



classic 1910



Dual outlet (shower / shower)
W 112 H 208

HIGH PRESSURE TK12
LOW PRESSURE TK13



Dual outlet (bath / shower)
W 112 H 208

HIGH PRESSURE TK14
LOW PRESSURE TK15



Single outlet
W 95 H 95

HIGH PRESSURE TK10
LOW PRESSURE TK11



Remote control (optional)
W 95 H 95

TK5

SHOWER SETS



CLASSIC 1910
SINGLE OUTLET SET

Single outlet digital processor
Traditional trim kit
Wall arm
9" AirBurst shower head
High pressure TK1M
Low pressure TK6M
Remote control TK5



6" Airburst shower head

WALL ARM
HIGH PRESSURE TK1S
LOW PRESSURE TK6S

CEILING ARM
HIGH PRESSURE TK1CS
LOW PRESSURE TK6CS

9" Airburst shower head

CEILING ARM
HIGH PRESSURE TK1CM
LOW PRESSURE TK6CM

12" Airburst shower head

WALL ARM
HIGH PRESSURE TK1L
LOW PRESSURE TK6L

CEILING ARM
HIGH PRESSURE TK1CL
LOW PRESSURE TK6CL



CLASSIC 1910
DUAL OUTLET SET

Dual outlet digital processor
Traditional trim kit
Wall arm
9" AirBurst shower head
Traditional slide bar kit
High pressure TK3M
Low pressure TK8M
Remote control TK5



6" Airburst shower head

WALL ARM
HIGH PRESSURE TK3S
LOW PRESSURE TK8S

CEILING ARM
HIGH PRESSURE TK3CS
LOW PRESSURE TK8CS

9" Airburst shower head

CEILING ARM
HIGH PRESSURE TK3CM
LOW PRESSURE TK8CM

12" Airburst shower head

WALL ARM
HIGH PRESSURE TK3L
LOW PRESSURE TK8L

CEILING ARM
HIGH PRESSURE TK3CL
LOW PRESSURE TK8CL



CLASSIC 1910
SINGLE OUTLET SET

Single outlet digital processor
Traditional trim kit
Traditional slide bar kit
High pressure TK2
Low pressure TK7
Remote control TK5



Soap basket for slide bar

HIGH PRESSURE TK2B
LOW PRESSURE TK7B



Cradle

TKV24



CLASSIC 1910
DUAL OUTLET SET

Dual outlet digital processor
Traditional trim kit
Wall arm
9" AirBurst shower head
Traditional slide bar kit
Soap basket for slide bar
High pressure TK3MB
Low pressure TK8MB
Remote control TK5



6" Airburst shower head

WALL ARM
HIGH PRESSURE TK3SB
LOW PRESSURE TK8SB

CEILING ARM
HIGH PRESSURE TK3CSB
LOW PRESSURE TK8CSB

9" Airburst shower head

CEILING ARM
HIGH PRESSURE TK3CMB
LOW PRESSURE TK8CMB

12" Airburst shower head

WALL ARM
HIGH PRESSURE TK3LB
LOW PRESSURE TK8LB

CEILING ARM
HIGH PRESSURE TK3CLB
LOW PRESSURE TK8CLB



SET OPTIONS

To upgrade the set, replace the code to the left with the code for your choice of product from the list on the right.



SHOWER SETS



CLASSIC 1910
DUAL OUTLET SET

Dual outlet digital processor
Traditional trim kit
Wall arm
9" AirBurst shower head
Handspray kit (including shower hook, telephone handset & hose 1/2" outlet elbow)
High pressure TK3MH
Low pressure TK8MH
Remote control TK5

6" Airburst shower head

WALL ARM
HIGH PRESSURE TK1S
LOW PRESSURE TK6S

CEILING ARM
HIGH PRESSURE TK1CS
LOW PRESSURE TK6CS

9" Airburst shower head

CEILING ARM
HIGH PRESSURE TK1CM
LOW PRESSURE TK6CM

12" Airburst shower head

WALL ARM
HIGH PRESSURE TK1L
LOW PRESSURE TK6L

CEILING ARM
HIGH PRESSURE TK1CL
LOW PRESSURE TK6CL



CLASSIC 1910
BATH SHOWER SET

Dual outlet digital processor
Traditional trim kit
Wall arm
9" AirBurst shower head
Xofill (bath waste with bath filler)
High pressure TK4M
Low pressure TK9M
Remote control TK5

6" Airburst shower head

WALL ARM
HIGH PRESSURE TK4S
LOW PRESSURE TK9S

CEILING ARM
HIGH PRESSURE TK4CS
LOW PRESSURE TK9CS

9" Airburst shower head

CEILING ARM
HIGH PRESSURE TK4CM
LOW PRESSURE TK9CM

12" Airburst shower head

WALL ARM
HIGH PRESSURE TK4L
LOW PRESSURE TK9L

CEILING ARM
HIGH PRESSURE TK4CL
LOW PRESSURE TK9CL



CLASSIC 1910
BATH SHOWER SET

Dual outlet digital processor
Traditional trim kit
Xofill (bath waste with bath filler)
Handspray kit (including shower hook, telephone handset & hose 1/2" outlet elbow)
High pressure TK4H
Low pressure TK9H
Remote control TK5 (OPTIONAL EXTRA)



SET OPTIONS

To upgrade the set, replace the code to the left with the code for your choice of product from the list on the right.

Accessories

Our range of accessories will provide the finishing touches to ensure your bathroom looks and functions perfectly. From classically styled chrome soap dishes, to ceramic toothbrush holders, every item is traditionally crafted in chrome plated solid brass, to guarantee the balance of functionality and style.





Soap dish
W 160 L 150 H 60

A1 CHR



Tumbler holder
W 80 L 120 H 110

A2 CHR



Single soap dispenser
W 80 L 140 H 210

A19 CHR



Double soap dispenser
W 190 L 130 H 210

A20 CHR



WC roll holder
W 80 L 180 H 120

A5 CHR



WC roll holder
W 100 L 180 H 100

A16 CHR
Without cover



Spire WC roll holder
W 170 L 60 H 250

A45 CHR



Spare WC roll holder
W 120 L 60 H 80

A6 CHR



Surface mounted
soap dispenser
W 70 L 70 H 110

A48 CHR
Can be mounted through a ceramic
basin tap hole or a work surface



Towel ring
W 170 L 60 H 200

A3 CHR



WC brush holder
W 100 L 150 H 430

A8 CHR



Robe hook
W 60 L 60 H 60

A14 CHR



Double robe hook
W 60 L 110 H 120

A4 CHR



Accessory back plate
W 30 L 60 H 60

G13



Medium ornate bracket
W 230 L 20 H 160

T32 CHR

ACCESSORIES INFORMATION

All accessories are supplied with extra chrome plated domed head screws.

All accessories have 'screw-through' (patent pending) design to ensure no lateral movement.



Triple robe hook
W 100 L 70 H 90

A47 CHR

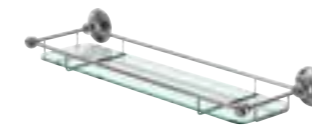

Glass shelf with railing
W 530 L 160 H 60

A18 CHR



Brass extendable bath rack
W 590-900 L 210 H 90

A27 CHR



Towel rack
W 660 L 320 H 140

A46 CHR

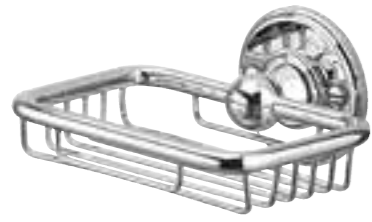

Soap basket
W 140 L 120 H 60

A13 CHR



Sponge basket
W 220 L 180 H 60

A15 CHR



Wire basket
W 330 L 160 H 90

A23 CHR



Angled rail with soap basket
left hand
W 435 L 124 H 201

A52 CHR



Angled rail with soap basket
right hand
W 435 L 124 H 201

A53 CHR



Straight rail
W 460 L 90 H 60

A54 CHR



Angled rail
W 396 L 89 H 190

A55 CHR



Corner basket
W 220 L 220 H 60

A21 CHR



Corner basket
W 28 L 280 H 90

A22 CHR



Burlington bath basket
W 290 L 240 H 110

A50 CHR



Single towel rail
W 550 L 60 H 60

A7 CHR



Double towel rail
W 660 L 150 H 170

A17 CHR



Burlington bath basket shown on
a roll top bath



radiators

Burlington radiators offer a broad range of various styles, with the recent addition of two black radiators.

There are options here to complement your traditional bathroom beautifully. All Burlington radiators except the Strand (R11 CHR) are designed to work with the extra fitting of an electric summer heating kit, allowing warm towels all year round..

ELECTRIC SUMMER HEATING KITS

Our radiators contain steel and are therefore only suitable for hot water (closed) central heating systems. During electric heating use the valves must be left open so the radiator is full of water to ensure correct performance.

All Electric heating kits are rated IP44.



Trafalgar Black
W 642 D 235 H 950

R1 CHR BLA
Shown with angled valves



Bloomsbury Black
W 497 D 235 H 950

R2 CHR BLA
Shown with angled valves



Angled Radiator Valves
W 85 D 65 H 235

R6 CHR BLA



Chaplin
W 542 D 126 H 1142

R12 CHR
Shown with angled valves



Trafalgar
W 642 D 235 H 950

R1 CHR
Shown with angled valves



Bloomsbury
W 497 D 235 H 950

R2 CHR
Shown with angled valves



Vincent
W 642 D 235 H 950

R5 CHR
Shown with angled valves



Berkeley
W 642 D 235 H 950

R4 CHR
Shown with angled valves



Cleaver
W 642 D 235 H 950

R3 CHR
Shown with angled valves



Strand
W 642 D 390 H 404

R11 CHR
Shown with angled valves



400W summer electric heating kit for Trafalgar

R10 CHR

250W summer electric heating kit for Bloomsbury & Vincent

R9 CHR

150W summer electric heating kit for Chaplin, Cleaver & Berkeley

R8 CHR



Framed 600 mirror
W 600 D 40 H 750

M6O*



Framed 600 mirror
W 600 D 40 H 750

M6O*

Radiator British Thermal Units (BTUs)

The heat outputs of our radiators connected to your central heating system:

	ΔT=50°C Watts	ΔT=55°C Watts	ΔT=60°C Watts	BTU's
Trafalgar	558	623	688	2346
Bloomsbury	387	430	473	1613
Vincent	206	227	246	839
Berkeley	238	263	289	985
Cleaver	266	294	323	1101
Strand	153	174	196	669
Chaplin	320	372	408	1392

All radiator outputs are tested to EN442

mirrors and lights

The perfect addition to your bathroom, Burlington mirrors add intricate detail and increase the period feel of your bathroom. Choose between the simplistic and pared back rectangular or arched mirrors, or the detailed and beautiful Georgian style mirrors available in polished black or white aluminium. In addition to the classic Edwardian lights either in round or elliptical style, Burlington have increased their range of lighting options, giving you various possibilities. Choose your base style in beautiful chrome and compliment with a fabric shade or a glass cup. These pieces are sure to give that extra finishing touch to your vintage look.

MIRRORS



Brushed aluminium frame
W 550 D 40 H 750

T37 ALU



Black aluminium frame
W 550 D 40 H 750

T47 BLA



White aluminium frame
W 550 D 40 H 750

T42 WHI



Arched
W 500 D 30 H 700

A9



Rectangular
W 500 D 30 H 700

A11



Curved
W 700 D 30 H 700

A38



Cosmetic wall mirror chrome
W 180 D 285 H 340

A57 CHR
Fully extended 440mm

LIGHTS



Burlington round light with chrome base and cup frosted glass shade
W 170 D 190 H 220

BL11



Burlington round light with chrome base and vase clear glass shade
W 120 D 170 H 300

BL14



Burlington round light with chrome base and tube frosted glass shade
W 120 D 150 H 300

BL13



Burlington round light with chrome base and fine pleated shade in white
W 150 D 180 H 230

BL12



Burlington round light with chrome base and chiffon silver shade
W 160 D 170 H 330

BL15

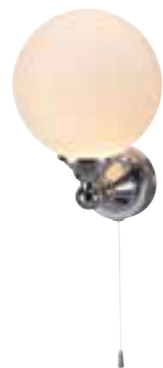

Edwardian single round LED light
W 160 D 170 H 250

T50



Edwardian single elliptical LED light
W 110 D 150 H 240

T52

ORNATE LIGHTS



Burlington ornate light with chrome base and cup frosted glass shade
W 170 D 230 H 280

BL21



Burlington ornate light with chrome base and vase clear glass shade
W 120 D 200 H 360

BL24



Burlington ornate light with chrome base and tube frosted glass shade
W 120 D 180 H 360

BL23



Burlington ornate light with chrome base and fine pleated shade in white
W 150 D 210 H 290

BL22



Burlington ornate light with chrome base and chiffon silver shade
W 160 D 210 H 290

BL25

TECHNICAL INFORMATION

Our Burlington ornate lights are supplied with G9 light bulbs. They are 28 watts, but give 40 watts of light and have an IP rating of IP44.

ARCADÉ

Introducing Arcade's range of exquisitely crafted bathroom pieces, lovingly designed to create a décor that is truly unique.

*E*xpertly finished in both nickel and chrome, the collection brings the archives of bygone design eras to the forefront whilst reflecting the trends seen in bathrooms today. Featuring beautiful ceramic sanitaryware, free-standing baths and stunning brassware masterpieces, Arcade effortlessly completes the luxury concept whilst distinguishing itself as the most acclaimed in bathroom styling.

Set to provide the ultimate in luxury for any traditional or contemporary setting, Arcade rebuffs against the limited lifespan of many of today's offerings whilst remaining classically stylish, guaranteeing a bathroom that will last a lifetime.



nickel

The durable, triple-layer nickel coating creates a long-lasting lustre on all our fixtures and fittings.

*O*ur signature finish, used throughout all of our brassware, accessories and fittings, the durable triple-layered nickel coating creates a long-lasting lustre on all of our fixtures, ensuring that your luxury bathroom is truly timeless in both its style and functionality.

The meticulous three-step manufacturing process protects, strengthens and adds extra shine to the brassware, resulting in a truly sophisticated look for the bathroom. Immersed into a nickel-plating tank to add a protective layer to the brassware, each piece is then chrome plated to provide resistance to corrosion before finally another coating of nickel is cascaded over the product to finish the process, adding an extra protective film.

chrome

Blending contemporary finishes with classic design for a beautifully harmonised bathroom setting.

*A*rcade successfully displays how contemporary styles can be blended with classic design through the launch of their new chrome collection. Harmonising beautifully with the range's timeless ceramics, the chrome brassware is lighter in colour than the original nickel finish, offering the option for a delicately styled bathroom décor.

Arcade's chrome collection reflects modern interior trends seen today, whilst demonstrating beautiful design, expert manufacturing techniques and perfect functionality for a bathroom that provides the ultimate in luxury design.



Iconic

Our iconic products bring the Arcade collection to life offering true decadence in the bathroom. Choose from our Arcade bicycle as an eye catching centrepiece or the opulent Piccadilly shower temple. The Royal showering bath is also available in either left or right handed options for those looking for a truly luxurious bathroom addition.





pashley bicycle

The Arcade bicycle is inspiring and eye-catching which adds a unique character to the basin. Pair with wall mounted brassware in chrome or nickel to make the most of your centre piece.

Pashley bicycle
 Bicycle W 1794 D 600 H 1100
 Shelf W 840 D 550 H 45

BICYCLE BICY1
 BASIN ARC600

OPTIONAL OAK SHELF BICYSHLF

Compliance / Approvals
 BS EN 14688:2006 Sanitary appliances. Wash basins. Functional requirements and test methods.
 BS EN 31:2011 Pedestal wash basins. Connecting dimensions.



royal

Royal free standing over bath
 shower temple
 W 1650 L 990 H 2250

LEFT HAND H402-ARC
 RIGHT HAND H403-ARC

ADDITION KIT* ARC63 NKL



ROYAL ADDITION KIT*

Bath volume 250 litres (Volume of water contained in the bath if filled to the overflow), glass thickness 8mm, safety glass with Easy Clean Coating
 Air boosted rain shower rose. The Royal shower temple is designed to operate between pressures of 3 and 5 Bar.
 For more flow rate information see the technical specification on our website
 *Including an extended pipe and two fixing pipes - nickel. Height gained: 150mm



All measurements are represented in mm. For detailed dimensions see burlingtonbathrooms.com

piccadilly



PICCADILLY ADDITION KIT*

Piccadilly free standing shower temple
W 1000 L 1000 H 2250

H404-ARC

ADDITION KIT* ARC62 NKL
SUPPORTING BAR ARC61 NKL

The Piccadilly shower temple is designed to operate between pressures of 3 and 5 Bar.
For more flow rate information see the technical specification on our website.
Air boosted rain shower rose. Glass thickness 8mm. Safety glass with Easy Clean Coating
*Including an extended pipe and two fixing pipes - nickel. Height gained: 150mm



Ceramics

Our iconic products bring the Arcade collection to life offering true decadence in the bathroom. Choose from our Arcade bicycle as an eye catching centrepiece or the opulent Piccadilly shower temple. The Royal showering bath is also available in either left or right handed options for those looking for a truly luxurious bathroom addition.



basins



500mm cloakroom basin with overflow
W 500 D 400 H 325

ARC500



600mm basin with overflow and pedestal
W 605 D 525 H 840

BASIN ARC600
PEDESTAL ARC1



900mm basin with overflow and pedestal
W 905 D 550 H 840

BASIN ARC900
PEDESTAL ARC1



600mm basin with overflow and ceramic
console legs
W 605 D 525 H 840

BASIN ARC600
LEGS ARC2



900mm basin with overflow and ceramic
console legs
W 905 D 550 H 840

BASIN ARC900
LEGS ARC2



1200mm basin with overflow and ceramic
console legs
W 1215 D 560 H 840

BASIN ARC1200
LEGS ARC2

Compatible wastes: ARCW19, ARCW14 (Add NKL for Nickel, CHR for Chrome).
These basins require a chrome overflow ring, included free of charge A68 CHR.
Tap holes ARC500: 1RH (as shown) or 2. Tap holes ARC600/900: 0 (as shown), 1, 2 or 3.

Compatible wastes: ARCW18, ARCW19, ARCW14 (Add NKL for Nickel, CHR for Chrome).
These basins require a chrome overflow ring, included free of charge A68 CHR.
Tap holes: 0, 1, 2 or 3.

nickel



chrome



Ceramics



600mm basin with overflow and stand
W 605 D 525 H 840

BASIN ARC600
STAND WITH GLASS SHELF ARC22



900mm basin with overflow and stand
W 905 D 550 H 840

BASIN ARC900
STAND WITH GLASS SHELF ARC23



1200mm double basin with double
overflow and stand
W 905 D 550 H 840

BASIN ARC1200
STAND WITH GLASS SHELF ARC24



600mm basin with overflow and stand
W 605 D 525 H 840

BASIN ARC600
STAND WITH GLASS SHELF ARC22 CHR



900mm basin with overflow and stand
W 905 D 550 H 840

BASIN ARC900
STAND WITH GLASS SHELF ARC23 CHR



1200mm double basin with double
overflow and stand
W 905 D 550 H 840

BASIN ARC1200
STAND WITH GLASS SHELF ARC24 CHR

Basin stands are constructed from stainless steel and have a nickel plate finish.
Compatible wastes: ARCW18 NKL, ARCW19 NKL, ARCW14 NKL.
These basins require a chrome overflow ring, included free of charge A68 CHR. Tap holes: 0, 1, 2 or 3 (as shown).

Basin stands are constructed from stainless steel and have a chrome plate finish.
Compatible wastes: ARCW18 CHR, ARCW19 CHR, ARCW14 CHR.
These basins require a chrome overflow ring, included free of charge A68 CHR. Tap holes: 0, 1, 2 or 3 (as shown).



Open back close coupled pan and dual flush cistern
W 500 D 665 H 885

PAN ARC3
CISTERN WITH LEVER ARC5
TOTAL



Full back to wall close coupled pan and dual flush cistern
W 500 D 670 H 885

PAN ARC4
CISTERN WITH LEVER ARC5
TOTAL



Back to wall pan
W 365 D 520 H 460

ARC6



Back to wall bidet with overflow and one tap basin
W 365 D 520 H 460

ARC7



Gloss white soft close seat
W 385 D 465 H 75

ARCS45 NKL



Gloss black soft close seat
W 385 D 465 H 75

ARCS40 NKL



Sand soft close seat
W 385 D 465 H 75

ARCS43 NKL



Dark olive soft close seat
W 385 D 465 H 75

ARCS44 NKL

Arcade soft close seats require chrome hinges A70 CHR.
Handles are sold separately:
Chrome A51 CHR
Nickel ARCA51 NKL

Baths

Choose from five bath options in the Arcade collection. Pair these with beautiful accessories and brassware in either chrome or nickel for the perfect bathing experience. For those looking for an opulent centerpiece choose the Albany or Albermarle to complete the bathroom.



albany



A beautifully crafted matt finish stone bath created for those with a spacious and decadent bathroom. Curved edges mean this bath is comfortable and elegant.

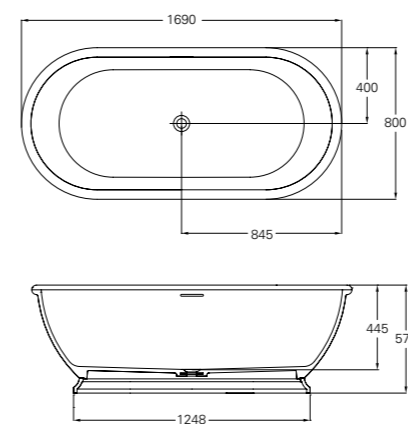

Albany free standing natural stone bath
W 800 L 1690 H 570

ARC21



Tap Hole Options
Not suitable for rim mounted taps

Overflow
Integrated overflow (excluding the bath waste)

· ALL · Albany free-standing natural stone bath with overflow and waste, shown with bath shower mixer and stand pipes in nickel.

All measurements are represented in mm. For detailed dimensions see burlingtonbathrooms.com

albermarle



A striking centrepiece bath with nickel surround. Make a statement in your bathroom and pair this with a matching nickel washstand for a stunning Art Deco theme.

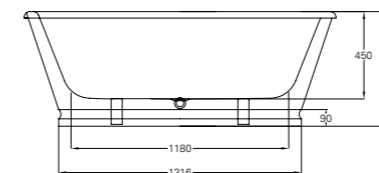
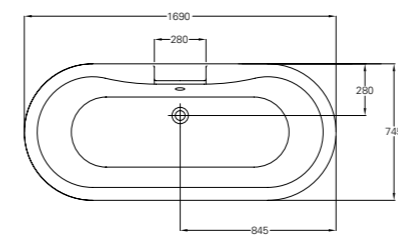

· ALL · Albermarle freestanding bath with nickel finish shown with deck mounted bath shower mixer in nickel finish.



Albermarle free standing bath with nickel finish
W 745 L 1690 H 615

ARC25

- ACRYLIC
-
-
-
- STAINLESS STEEL
- NICKEL FINISH

Compatible wastes
ARCW4, ARCW3 (add NKL for nickel, CHR for chrome)

Tap Hole Options
0, 1, 2 (supplied undrilled)
Overflow
Pre drilled

vine



The Vine is a free-standing natural stone bath with a stunning matte finish and slightly higher curved edges to ensure a comfortable bathe.

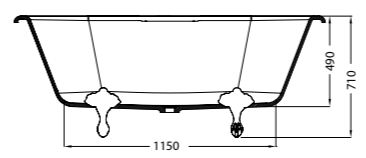
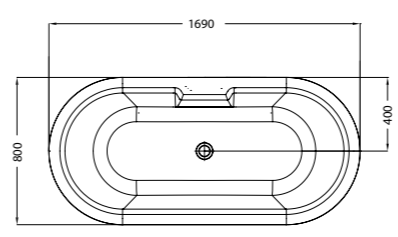

· ALL · Vine natural stone bath shown with nickel bath shower mixer and nickel feet.



Vine free standing natural stone bath
W 800 L 1690 H 710

BATH ARC38



LEGS ARCE11 NKL

Compatible wastes
ARCCW3, ARCW3, ARCW21,
ARCW4NKL, ARCW4CHR (add NKL
for nickel, CHR for chrome)

Tap Hole Options
0, 1, 2 (supplied undrilled)
Overflow
Undrilled



The Vigo also has a matte finish and is included within the natural stone range from Arcade. Pair this with either Chrome or Nickel feet for the classic roll top option.

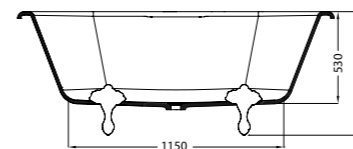
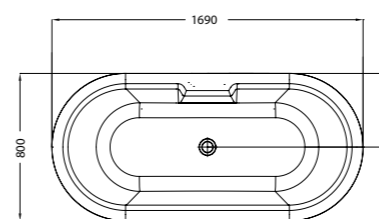

· ALL · Vigo natural stone bath shown with deck mounted bath shower mixer and nickel feet.



Vigo free standing natural stone bath
W 800 L 1690 H 670

BATH ARC37



LEGS ARCE11 NKL

Compatible wastes
ARCCW3, ARCW3, ARCW21,
ARCW4NKL, ARCW4CHR (add NKL
for nickel, CHR for chrome)

Tap Hole Options
0, 1, 2 (supplied undrilled)
Overflow
Undrilled



The Sackville natural stone slipper bath provides the ultimate in comfortable bathing. Pair with the Nickel feet to create an opulent finish in any bathroom.

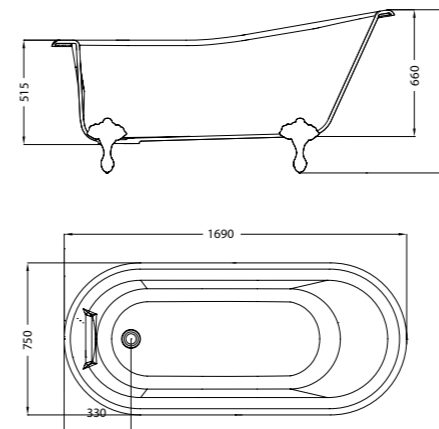

· ALL · Sackville natural stone bath shown with deck mounted bath shower mixer in nickel finish.



Sackville free standing natural stone bath
W 750 L 1690 H 650 / 800

BATH ARC39



LEGS ARCE11 NKL

Compatible wastes
ARCCW3, ARCW3, ARCW21,
ARCW4NKL, ARCW4CHR (add NKL
for nickel, CHR for chrome)

Tap Hole Options
0, 1, 2 (supplied undrilled)
Overflow
Undrilled

Brassware

The exquisitely crafted brassware within the Arcade collection is designed to create a truly unique addition in your bathroom.

The Chrome option blends a contemporary finish with classic design offering a delicately styled brassware option. The Nickel option is the signature finish and uses a durable triple layered nickel coating creating long lasting lustre on all Nickel taps and valves.



CROSSHEAD

LEVER

WHITE CERAMIC LEVER

MATT BLACK CERAMIC LEVER



Dual lever basin mixer without pop up waste
W 200 L 184 H 215

Dual lever basin mixer without pop up waste
W 200 L 184 H 215

Dual lever basin mixer without pop up waste
W 200 L 184 H 215

Dual lever basin mixer without pop up waste
W 200 L 184 H 215

NICKEL ARC14

NICKEL TAP ARC14
NICKEL LEVER ARC67 NKL

NICKEL TAP ARC14
WHITE LEVER ARC65 NKL

NICKEL TAP ARC14
BLACK LEVER ARC66 NKL

CROSSHEAD

LEVER

WHITE CERAMIC LEVER

MATT BLACK CERAMIC LEVER



Dual lever basin mixer without pop up waste
W 200 L 184 H 215

Dual lever basin mixer without pop up waste
W 200 L 184 H 215

Dual lever basin mixer without pop up waste
W 200 L 184 H 215

Dual lever basin mixer without pop up waste
W 200 L 184 H 215

CHROME ARC14 CHR

CHROME TAP ARC14 CHR
CHROME LEVER ARC67 CHR

CHROME TAP ARC14 CHR
WHITE LEVER ARC65 CHR

CHROME TAP ARC14 CHR
BLACK LEVER ARC66 CHR



Single lever basin mixer without pop up waste
W 65 L 174 H 174

Single lever basin mixer without pop up waste
W 65 L 174 H 174

Dual lever basin mixer without pop up waste
W 200 L 184 H 215

Dual lever basin mixer without pop up waste
W 200 L 184 H 215

NICKEL ARC12

NICKEL TAP ARC12
NICKEL LEVER ARC67 NKL

NICKEL TAP ARC12
WHITE LEVER ARC65 NKL

NICKEL TAP ARC12
BLACK LEVER ARC66 NKL



Single lever basin mixer without pop up waste
W 65 L 174 H 174

Single lever basin mixer without pop up waste
W 65 L 174 H 174

Dual lever basin mixer without pop up waste
W 200 L 184 H 215

Dual lever basin mixer without pop up waste
W 200 L 184 H 215

CHROME ARC12 CHR

CHROME TAP ARC12 CHR
CHROME LEVER ARC67 CHR

CHROME TAP ARC12 CHR
WHITE LEVER ARC65 CHR

CHROME TAP ARC12 CHR
BLACK LEVER ARC66 CHR



Mini single lever basin mixer without pop up waste
W 59 L 137 H 107

Mini single lever basin mixer without pop up waste
W 59 L 137 H 107

Mini single lever basin mixer without pop up waste
W 59 L 137 H 107

Mini single lever basin mixer without pop up waste
W 59 L 137 H 107

NICKEL ARC35

NICKEL TAP ARC35
NICKEL LEVER ARC67 NKL

NICKEL TAP ARC35
WHITE LEVER ARC65 NKL

NICKEL TAP ARC35
BLACK LEVER ARC66 NKL



Mini single lever basin mixer without pop up waste
W 59 L 137 H 107

Mini single lever basin mixer without pop up waste
W 59 L 137 H 107

Mini single lever basin mixer without pop up waste
W 59 L 137 H 107

Mini single lever basin mixer without pop up waste
W 59 L 137 H 107

CHROME ARC35 CHR

CHROME TAP ARC35 CHR
CHROME LEVER ARC67 CHR

CHROME TAP ARC35 CHR
WHITE LEVER ARC65 CHR

CHROME TAP ARC35 CHR
BLACK LEVER ARC66 CHR

CROSSHEAD

LEVER

WHITE CERAMIC LEVER

MATT BLACK CERAMIC LEVER



Three hole basin mixer deck mounted without pop up waste
W 260 L 219 H 158

Three hole basin mixer deck mounted without pop up waste
W 260 L 219 H 158

Three hole basin mixer deck mounted without pop up waste
W 260 L 219 H 158

Three hole basin mixer deck mounted without pop up waste
W 260 L 219 H 158

NICKEL ARC15

NICKEL TAP ARC15
NICKEL LEVER ARC67 NKL

NICKEL TAP ARC15
WHITE LEVER ARC65 NKL

NICKEL TAP ARC15
BLACK LEVER ARC66 NKL

CROSSHEAD

LEVER

WHITE CERAMIC LEVER

MATT BLACK CERAMIC LEVER



Three hole basin mixer deck mounted without pop up waste
W 260 L 219 H 158

Three hole basin mixer deck mounted without pop up waste
W 260 L 219 H 158

Three hole basin mixer deck mounted without pop up waste
W 260 L 219 H 158

Three hole basin mixer deck mounted without pop up waste
W 260 L 219 H 158

CHROME ARC15 CHR

CHROME TAP ARC15 CHR
CHROME LEVER ARC67 CHR

CHROME TAP ARC15 CHR
WHITE LEVER ARC65 CHR

CHROME TAP ARC15 CHR
BLACK LEVER ARC66 CHR



Three hole basin mixer wall mounted without pop up waste
W 260 L 250 H 158

Three hole basin mixer wall mounted without pop up waste
W 260 L 250 H 158

Three hole basin mixer wall mounted without pop up waste
W 260 L 250 H 158

Three hole basin mixer wall mounted without pop up waste
W 260 L 250 H 158

NICKEL ARC16

NICKEL TAP ARC16
NICKEL LEVER ARC67 NKL

NICKEL TAP ARC16
WHITE LEVER ARC65 NKL

NICKEL TAP ARC16
BLACK LEVER ARC66 NKL



Three hole basin mixer wall mounted without pop up waste
W 260 L 250 H 158

Three hole basin mixer wall mounted without pop up waste
W 260 L 250 H 158

Three hole basin mixer wall mounted without pop up waste
W 260 L 250 H 158

Three hole basin mixer wall mounted without pop up waste
W 260 L 250 H 158

CHROME ARC16 CHR

CHROME TAP ARC16 CHR
CHROME LEVER ARC67 CHR

CHROME TAP ARC16 CHR
WHITE LEVER ARC65 CHR

CHROME TAP ARC16 CHR
BLACK LEVER ARC66 CHR



Basin pillar taps
W 239 L 161 H 150

Basin pillar taps
W 239 L 161 H 150

Basin pillar taps
W 239 L 161 H 150

Basin pillar taps
W 239 L 161 H 150

NICKEL ARC17

NICKEL TAP ARC17
NICKEL LEVER ARC67 NKL

NICKEL TAP ARC17
WHITE LEVER ARC65 NKL

NICKEL TAP ARC17
BLACK LEVER ARC66 NKL



Basin pillar taps
W 239 L 161 H 150

Basin pillar taps
W 239 L 161 H 150

Basin pillar taps
W 239 L 161 H 150

Basin pillar taps
W 239 L 161 H 150

CHROME ARC17 CHR

CHROME TAP ARC17 CHR
CHROME LEVER ARC67 CHR

CHROME TAP ARC17 CHR
WHITE LEVER ARC65 CHR

CHROME TAP ARC17 CHR
BLACK LEVER ARC66 CHR

CROSSHEAD

LEVER

WHITE CERAMIC LEVER

MATT BLACK CERAMIC LEVER

CROSSHEAD

LEVER

WHITE CERAMIC LEVER

MATT BLACK CERAMIC LEVER



Cloakroom basin pillar taps
W 239 L 132 H 140

Cloakroom basin pillar taps
W 239 L 132 H 140

Cloakroom basin pillar taps
W 239 L 132 H 140

Cloakroom basin pillar taps
W 239 L 132 H 140

Cloakroom basin pillar taps
W 239 L 132 H 140

Cloakroom basin pillar taps
W 239 L 132 H 140

Cloakroom basin pillar taps
W 239 L 132 H 140

Cloakroom basin pillar taps
W 239 L 132 H 140

NICKEL ARC36

NICKEL TAP ARC36
NICKEL LEVER ARC67 NKL

NICKEL TAP ARC36
WHITE LEVER ARC65 NKL

NICKEL TAP ARC36
BLACK LEVER ARC66 NKL

CHROME ARC36 CHR

CHROME TAP ARC36 CHR
CHROME LEVER ARC67 CHR

CHROME TAP ARC36 CHR
WHITE LEVER ARC65 CHR

CHROME TAP ARC36 CHR
BLACK LEVER ARC66 CHR



Single lever bidet mixer with
pop up waste
W 65 L 192 H 174

Single lever bidet mixer with
pop up waste
W 65 L 192 H 174

Single lever bidet mixer with
pop up waste
W 65 L 192 H 174

Single lever bidet mixer with
pop up waste
W 65 L 192 H 174

Single lever bidet mixer with
pop up waste
W 65 L 192 H 174

Single lever bidet mixer with
pop up waste
W 65 L 192 H 174

Single lever bidet mixer with
pop up waste
W 65 L 192 H 174

Single lever bidet mixer with
pop up waste
W 65 L 192 H 174

NICKEL ARC13

NICKEL TAP ARC13
NICKEL LEVER ARC67 NKL

NICKEL TAP ARC13
WHITE LEVER ARC65 NKL

NICKEL TAP ARC13
BLACK LEVER ARC66 NKL

CHROME ARC13 CHR

CHROME TAP ARC13 CHR
CHROME LEVER ARC67 CHR

CHROME TAP ARC13 CHR
WHITE LEVER ARC65 CHR

CHROME TAP ARC13 CHR
BLACK LEVER ARC66 CHR



Bath shower mixer
wall mounted
W 290 L 280 H 327

Bath shower mixer
wall mounted
W 290 L 280 H 327

Bath shower mixer
wall mounted
W 290 L 280 H 327

Bath shower mixer
wall mounted
W 290 L 280 H 327

Bath shower mixer
wall mounted
W 290 L 280 H 327

Bath shower mixer
wall mounted
W 290 L 280 H 327

Bath shower mixer
wall mounted
W 290 L 280 H 327

Bath shower mixer
wall mounted
W 290 L 280 H 327

NICKEL ARC19

NICKEL TAP ARC19
NICKEL LEVER ARC67 NKL

NICKEL TAP ARC19
WHITE LEVER ARC65 NKL

NICKEL TAP ARC19
BLACK LEVER ARC66 NKL

CHROME ARC19 CHR

CHROME TAP ARC19 CHR
CHROME LEVER ARC67 CHR

CHROME TAP ARC19 CHR
WHITE LEVER ARC65 CHR

CHROME TAP ARC19 CHR
BLACK LEVER ARC66 CHR

CROSSHEAD

LEVER

WHITE CERAMIC LEVER

MATT BLACK CERAMIC LEVER

CROSSHEAD

LEVER

WHITE CERAMIC LEVER

MATT BLACK CERAMIC LEVER



Bath shower mixer deck mounted
W 290 L 370 H 400

Bath shower mixer deck mounted
W 290 L 370 H 400

Bath shower mixer deck mounted
W 290 L 370 H 400

Bath shower mixer deck mounted
W 290 L 370 H 400

Bath shower mixer deck mounted
W 290 L 370 H 400

Bath shower mixer deck mounted
W 290 L 370 H 400

Bath shower mixer deck mounted
W 290 L 370 H 400

Bath shower mixer deck mounted
W 290 L 370 H 400

NICKEL ARC18

NICKEL TAP ARC18
NICKEL LEVER ARC67 NKL

NICKEL TAP ARC18
WHITE LEVER ARC65 NKL

NICKEL TAP ARC18
BLACK LEVER ARC66 NKL

CHROME ARC18 CHR

CHROME TAP ARC18 CHR
CHROME LEVER ARC67 CHR

CHROME TAP ARC18 CHR
WHITE LEVER ARC65 CHR

CHROME TAP ARC18 CHR
BLACK LEVER ARC66 CHR



Single lever bath shower filler, floor mounted inc. floor mounting kit
W 120 L 373 H 825 - 907

NICKEL ARC20
Matt black ceramic tap lever now available for this bath filler, order separately ARC69 NKL.



Single lever bath shower filler, floor mounted inc. floor mounting kit
W 120 L 373 H 825 - 907

CHROME ARC20 CHR
Matt black ceramic tap lever now available for this bath filler, order separately ARC69 CHR.



Showering



THERMOSTATIC SAFETY / ANTI LIMESCALE · We use Vernet wax capsules throughout our showering valves, meaning temperature when showering will now vary by more than +/- 1°C. The quality materials minimise potential limescale effects enabling extended lifetimes.



CERAMIC DISC TECHNOLOGY · Burlington offers ceramic disc technology across its showering range.



ONE WAY WATER · Our non-return valves ensure the flow of water in only one direction, ensuring heating efficiency, preventing siphonage of contaminated water and keeping your shower cartridge in excellent condition for longer.



AIRBURST · By combining air and water, the pressure inside the shower head is increased. The power of a traditional shower with up to 33% water saved.

NICKEL



Shower valve, shower arm and shower head packs

NICKEL WITH 9" SHOWER HEAD
ARC73 + ARCV17 NKL

NICKEL WITH 12" SHOWER HEAD
ARC73 + ARCV60 NKL



Shower valve, shower arm, shower head, rail, handset and hose packs

NICKEL WITH 9" SHOWER HEAD
ARC64 + ARCV17 NKL

NICKEL WITH 12" SHOWER HEAD
ARC64 + ARCV60 NKL



Arcade Avon exposed thermostatic shower valve, standard vertical riser, straight shower arm for vertical riser mounting, 9 inch shower rose, soap basket for vertical riser, telephone handset & hose

NICKEL WITH 9" SHOWER HEAD
BARC74 + ARCV17 NKL

NICKEL WITH 12" SHOWER HEAD
BARC74 + ARCV60 NKL

CHROME



Shower valve, shower arm and shower head packs

CHROME WITH 9" SHOWER HEAD
ARC73 CHR + ARCV17 CHR

CHROME WITH 12" SHOWER HEAD
ARC73 CHR + ARCV60 CHR

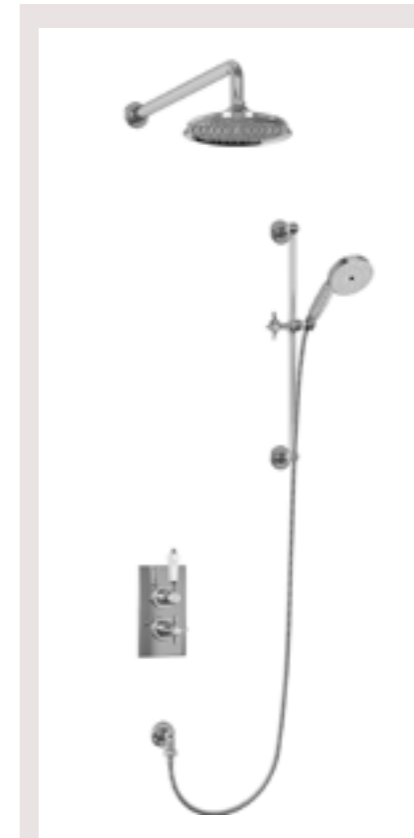

Shower valve, shower arm, shower head, rail, handset and hose packs

CHROME WITH 9" SHOWER HEAD
ARC64 CHR + ARCV17 CHR

CHROME WITH 12" SHOWER HEAD
ARC64 CHR + ARCV60 CHR



Arcade Avon exposed thermostatic shower valve, standard vertical riser, straight shower arm for vertical riser mounting, 9 inch shower rose, soap basket for vertical riser, telephone handset & hose

CHROME WITH 9" SHOWER HEAD
BARC74 CHR + ARCV17 CHR

CHROME WITH 12" SHOWER HEAD
BARC74 CHR + ARCV60 CHR

EXTRAS (ONLY COMPATIBLE WITH BARC74 AND BARC74 CHR)

Matt black ceramic valve levers now available to order as a pair, order ARC68 when ordering your shower.



Spout

NICKEL ARCV32 NKL
CHROME ARCV32 CHR



Diverter for handset

NICKEL ARCV31 NKL
CHROME ARCV31 CHR



Adjustable shower handset bracket

CHROME ARCV34 CHR



Long riser rail

NICKEL ARCV22 NKL
CHROME ARCV22 CHR



Soap basket for vertical riser

NICKEL ARCV23 NKL
CHROME ARCV23 CHR



THERMOSTATIC SAFETY



AIRBURST



ANTI LIMESCALE



CERAMIC DISC TECHNOLOGY



ONE WAY WATER

Accessories

Offering an extensive range of accessories in both the original nickel finish and chrome finish. Arcade allows you to create a decor that best matches your interior scheme. For a truly Art Deco theme add a china soap dish or a nickel bath rack.



NICKEL



Wall mounted china soap dish
W 160 L 161 H 60

NICKEL ARCA1 NKL



Wall mounted china mug and holder
W 80 L 126 H 110

NICKEL ARCA2 NKL



Wall mounted single soap dispenser ceramic
W 80 L 141 H 212

NICKEL ARCA19 NKL



Wall mounted brush and china holder
W 118 L 164 H 402

NICKEL ARCA8 NKL



Wall mounted towel ring
W 170 L 59 H 194

NICKEL ARCA3 NKL



Wall mounted double robe hook
W 60 L 105 H 116

NICKEL ARCA4 NKL



Wall mounted paper roll holder with brass bar
W 216 L 93 H 83

NICKEL ARCA5 NKL



Wall mounted robe hook
W 60 L 59 H 60

NICKEL ARCA14 NKL



Wall mounted sponge basket
W 269 L 186 H 65

NICKEL ARCA15 NKL



Wall mounted wire basket
W 330 L 155 H 102
62 deep (155 x 330)

NICKEL ARCA23 NKL



Wall mounted china soap dish
W 218 L 218 H 102
62 deep (215 x 215)

NICKEL ARCA22 NKL



Wall mounted extendable rack
W 895 L 203 H 70

NICKEL ARCA27 NKL

CHROME



Wall mounted china soap dish
W 160 L 161 H 60

CHROME ARCA1 CHR



Wall mounted china mug and holder
W 80 L 126 H 110

CHROME ARCA2 CHR



Wall mounted single soap dispenser ceramic
W 80 L 141 H 212

CHROME ARCA19 CHR



Wall mounted brush and china holder
W 118 L 164 H 402

CHROME ARCA8 CHR



Wall mounted towel ring
W 170 L 59 H 194

CHROME ARCA3 CHR



Wall mounted double robe hook
W 60 L 105 H 116

CHROME ARCA4 CHR



Wall mounted paper roll holder with brass bar
W 216 L 93 H 83

CHROME ARCA5 CHR



Wall mounted robe hook
W 60 L 59 H 60

CHROME ARCA14 CHR



Wall mounted sponge basket
W 269 L 186 H 65

CHROME ARCA15 CHR



Wall mounted wire basket
W 330 L 155 H 102
62 deep (155 x 330)

CHROME ARCA23 CHR



Wall mounted china soap dish
W 218 L 218 H 102
62 deep (215 x 215)

CHROME ARCA22 CHR



Wall mounted extendable rack
W 895 L 203 H 70

CHROME ARCA27 CHR

NICKEL



Bottle trap with extended wall tube

NICKEL ARCW14 NKL



Bidet trap

NICKEL ARCW27 NKL



Exposed P trap

NICKEL ARCCW3 NKL



Bath overflow, plug and chain

NICKEL ARCW3 NKL



Exposed bath trap to floor connection pipe

NICKEL ARCW21 NKL



Flip top basin waste
For basins with overflow

NICKEL ARCW18 NKL
Arcade waste exposed back nut sold separately ARCW19



Free standing paper roll china brush holder
W 257 L 295 H 844

NICKEL ARCA41 NKL



Free standing double paper roll holder
W 376 L 250 H 820

NICKEL ARCA42 NKL

CHROME



Bottle trap with extended wall tube

CHROME ARCW14 CHR



Bidet trap

CHROME ARCW27 CHR



Exposed P trap

CHROME ARCCW3 CHR



Bath overflow, plug and chain

CHROME ARCW3 CHR



Exposed bath trap to floor connection pipe

CHROME ARCW21 CHR



Flip top basin waste
For basins with overflow

CHROME ARCW18 CHR
Includes chrome back nut



Free standing paper roll china brush holder
W 257 L 295 H 844

CHROME ARCA41 CHR



Free standing double paper roll holder
W 376 L 250 H 820

CHROME ARCA42 CHR



Free standing triple tail rail stand
W 376 L 250 H 820

NICKEL ARCA43 NKL



Floor mounted exposed water pipes with support bar

NICKEL ARCW7 NKL



Floor mounted exposed decorative shrouds

NICKEL ARCW6 NKL



Exposed bath overflow, waste, plug and chain
Suitable for use with the Royal bath

NICKEL ARCW4 NKL

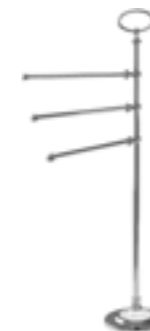

Free standing triple tail rail stand
W 376 L 250 H 820

CHROME ARCA43 CHR



Floor mounted exposed water pipes with support bar

CHROME ARCW7 CHR



Floor mounted exposed decorative shrouds

CHROME ARCW6 CHR



Exposed bath overflow, waste, plug and chain
Suitable for use with the Royal bath

CHROME ARCW4 CHR

radiators

All our Arcade radiators are available in Nickel and Chrome finish. Pair yours with matching brassware and accessories to complete the look.



Lansdowne / Trafalgar
W 600 D 235 H 950
Shown with angled valves (not included)

NICKEL (LANDSDOWNE) ARCR1 NKL
CHROME (TRAFALGAR) ARCR1 CHR



Bruton / Bloomsbury
W 457 D 235 H 950
Shown with angled valves (not included)

NICKEL (BRUTON) ARCR2 NKL
CHROME (BLOOMSBURY) ARCR2 CHR



Babble / Cleaver
W 600 D 235 H 667
Shown with angled valves (not included)

NICKEL (BABBLE) ARCR3 NKL
CHROME (CLEAVER) ARCR3 CHR



Angled radiator valve
W 65 L 65 H 125

NICKEL ARCR6 NKL
CHROME ARCR6 CHR



Straight radiator valve
W 65 L 86 H 99

NICKEL ARCR7 NKL
CHROME ARCR7 CHR

Radiator British Thermal Units (BTUs)
The heat outputs of our radiators connected to your central heating system:

	$\Delta T=50^{\circ}C$ Watts	$\Delta T=55^{\circ}C$ Watts	$\Delta T=60^{\circ}C$ Watts	BTU's
Lansdowne	558	623	688	2346
Bloomsbury	558	623	688	2346
Bruton	387	430	473	1613
Trafalgar	387	430	473	1613
Babble	266	294	323	1101
Cleaver	266	294	323	1101

ADDITIONAL INFORMATION

All radiator outputs are tested to EN442. Fill the radiator approximately 90% (Bruton 4.5L, Lansdowne 6.5L, Babble 2.0L) with a water mixture. Includes all brackets and fixings. High quality nickel/chrome plated finish. Valves are required - These are not included.

mirrors and lights



Square swivel mirror with nickel / chrome plated brass wall mounts
W 590 D 66 H 500

NICKEL ARCA39 NKL
CHROME ARCA39 CHR

Rectangular swivel mirror with curved corners and nickel / chrome plated brass wall mounts
W 590 D 66 H 620

NICKEL ARCA40 NKL
CHROME ARCA40 CHR

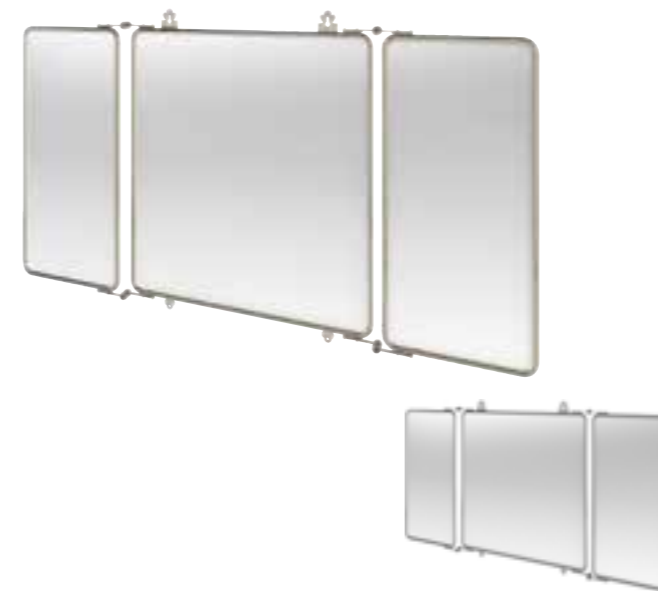

Three fold bathroom mirror with nickel / chrome plated brass frame
W 1143 D 30 H 600

NICKEL ARCA45 NKL
CHROME ARCA45 CHR



Oval base with cup frosted glass shade

AL11



Oval base with vase clear glass shade

AL14



Oval base with tube frosted glass shade

AL13



Oval base with fine pleated shade in white

AL12



Oval base with chiffon silver shade

AL15



Round light with chrome base and cup frosted glass shade
W 170 D 190 H 220

ARCBL11



Round light with chrome base and vase clear glass shade
W 120 D 170 H 300

ARCBL14



Round light with chrome base and tube frosted glass shade
W 120 D 150 H 300

ARCBL13



Round light with chrome base and fine pleated shade in white
W 150 D 180 H 230

ARCBL12



Round light with chrome base and chiffon silver shade
W 160 D 170 H 330

ARCBL15

TECHNICAL INFORMATION

Our Arcade ornate lights are supplied with G9 light bulbs. They are 28 watts, but give 40 watts of light and have an IP rating of IP44.



Join us on social

facebook.com/burlingtonbathrooms

instagram.com/burlingtonbaths

pinterest.com/burlingtonbaths

Due to continuous product improvements we reserve the right to change the product specification without prior notice. The text, images and layout of this catalogue are protected by copyright and other intellectual property rights. All images within this brochure are, where possible, a true representation of our products. Some colours may vary. Please visit the website for more information.

Our website should be used as reference for the most up to date product specification.

Burlington[®]

Lake View House, Rennie Drive, Dartford, Kent DA1 5FU

Tel: +44 (0)1322 473 222

Email: info@bathroombrands.com

burlingtonbathrooms.com



Part of the Bathroom Brands Group